

# LUXOR

## TO THE OWNER

---

Congratulations! We welcome you to the exciting world of motor home travel and camping. You will find it convenient and enjoyable to have all the comforts of home and still enjoy the great outdoors wherever you choose to go.

Your Luxor motor home has been carefully designed, engineered and manufactured to provide dependability as well as safety. Before sliding into the driver's seat, take a few minutes to become familiar with operations and features. This manual was prepared to aid you in the proper care and operation of the vehicle and equipment. We urge you to read it completely. In addition, spend some time with the dealer when you take delivery, you will want to learn all you can about your new motor home.

Your new Luxor motor home is covered by a factory warranty against defects in material and workmanship. This warranty should be validated at once and returned to the factory by your dealer.

Read and understand all instructions and precautions in this manual before operating your new motor home. Throughout this manual, certain items are labeled NOTE, CAUTION and WARNING. These terms alert you to precautions that can involve risk to your vehicle or to your personal safety. Read and follow them carefully.

*NOTE: Indicates a special point of information.*

### CAUTION

Indicates that a failure to observe can cause damage to vehicle or equipment

### WARNING

This symbol is used to alert you to precautions that involve your personal safety as well as vehicle damage. Read and follow them carefully.

|  |
|--|
| OWNER'S NAME                               |
| STREET ADDRESS                             |
| CITY AND STATE (OR PROVINCE IN CANADA)     |
| MOTOR HOME SERIAL NUMBER                   |
| VEHICLE CHASSIS IDENTIFICATION NO. (VIN)   |
| DATE OF DELIVERY TO FIRST RETAIL PURCHASER |
| VEHICLE MILEAGE AT TIME OF DELIVERY        |
| SELLING DEALER NAME AND ADDRESS            |

| <b>TANK CAPACITIES</b>  |                     |
|---|---------------------|
| <b>Diesel Chassis Fuel Tank</b>   | 100 gal.            |
| <b>LP Gas Tank</b>  | 109 lbs./25.7 gals. |
| <b>Fresh Water Tank</b><br>(2 tanks @ 47 gal.)  | 94 gal.             |
| <b>Water Heater</b>   | 6 gal.              |
| <b>Holding Tank 1 - Black Water (Toilet &amp; Bath Lavatory)</b><br><i>(Includes Optional Washer/Dryer)</i>                       | 58 gal.             |
| <b>Holding Tank 2 - Gray Water (Galley &amp; Shower)</b><br><i>(Includes Optional Dishwasher, Washer/Dryer, Bedroom Lavatory)</i> | 67 gal.             |



# LUXOR

## TABLE OF CONTENTS

---

### INTRODUCTION

|  |     |
|--|-----|
| Vehicle Chassis Operating Guide .....          | 0-1 |
| Motor Home Operations Manual<br>(Binder) ..... | 0-1 |
| Before Driving .....                           | 0-1 |
| Service Assistance .....                       | 0-2 |
| Drinking and Driving .....                     | 0-2 |
| Reporting Safety Defects .....                 | 0-2 |
| Vehicle Certification Label .....              | 0-3 |
| Exterior Feature Identification .....          | 0-4 |

### SECTION 1: SAFETY PRECAUTIONS

|                               |     |
|-------------------------------|-----|
| General Warnings .....        | 1-1 |
| Driving .....                 | 1-1 |
| Fuel & LP Gas .....           | 1-1 |
| LP Gas Leaks .....            | 1-2 |
| LP Gas Alarm .....            | 1-2 |
| Electrical .....              | 1-3 |
| Loading .....                 | 1-3 |
| Maintenance .....             | 1-4 |
| Formaldehyde Warning .....    | 1-4 |
| Carbon Monoxide Warning ..... | 1-4 |
| Carbon Monoxide Alarm .....   | 1-5 |
| Emergency Exit Window .....   | 1-5 |
| Fire Extinguisher .....       | 1-5 |
| Smoke Alarm .....             | 1-6 |

### SECTION 2: DRIVING YOUR MOTOR HOME

|                                    |     |
|------------------------------------|-----|
| Before Entering .....              | 2-1 |
| Before Driving .....               | 2-1 |
| Keys .....                         | 2-2 |
| Fuel Selection .....               | 2-2 |
| Fuel Fill .....                    | 2-2 |
| Fuel Tank Capacity .....           | 2-2 |
| Starting and Stopping Engine ..... | 2-2 |
| Engine Block Heater .....          | 2-2 |
| Parking Brake .....                | 2-3 |
| Exhaust Braking System .....       | 2-3 |
| Hazard Warning Lights .....        | 2-4 |
| Door Locks and Handles .....       | 2-4 |
| Entrance Door Prop Latch .....     | 2-5 |
| Keyless Entry System .....         | 2-4 |
| Entrance Door Prop Latch .....     | 2-5 |
| Keyless Entry System .....         | 2-5 |
| Entrance Step .....                | 2-6 |
| Entrance Stepwell Cover .....      | 2-7 |

|                                |      |
|--------------------------------|------|
| Mirrors .....                  | 2-7  |
| Rearview Monitor System .....  | 2-8  |
| Seats .....                    | 2-8  |
| Seat Belts .....               | 2-9  |
| Child Restraints .....         | 2-10 |
| Instrument Panel .....         | 2-11 |
| Speed Control (Cruise) .....   | 2-12 |
| Comfort Controls .....         | 2-13 |
| Heating .....                  | 2-13 |
| Defrosting .....               | 2-13 |
| Ventilation .....              | 2-13 |
| Air Conditioning .....         | 2-13 |
| Radio Switch .....             | 2-14 |
| Sound System .....             | 2-14 |
| Auxiliary Start Switch .....   | 2-14 |
| Auxiliary Battery Switch ..... | 2-15 |
| CB Radio Wiring .....          | 2-15 |
| Coach Leveling Systems .....   | 2-15 |

### SECTION 3: IN CASE OF DRIVING

#### EMERGENCY

|                                    |     |
|------------------------------------|-----|
| Hazard Flashers .....              | 3-1 |
| If You Get A Flat Tire .....       | 3-1 |
| Tire Changing .....                | 3-1 |
| Recovery Towing .....              | 3-1 |
| Jump Starting .....                | 3-1 |
| Connecting a Battery Charger ..... | 3-2 |
| Engine Overheat .....              | 3-3 |

### SECTION 4: TRAVELING WITH YOUR MOTOR HOME

|                                     |     |
|-------------------------------------|-----|
| Loading the Vehicle .....           | 4-1 |
| Front Axle Tire Alignment .....     | 4-1 |
| Weighing Your Loaded Vehicle .....  | 4-1 |
| Maximum Occupancy .....             | 4-1 |
| Roof Loading .....                  | 4-2 |
| Trailer Towing .....                | 4-2 |
| Pre-Travel Checklist .....          | 4-3 |
| Equipping For Travel                |     |
| Emergency Equipment Checklist ..... | 4-3 |
| Quick Loading Checklist .....       | 4-3 |
| Travel Tips .....                   | 4-4 |
| Severe Weather Information .....    | 4-5 |
| Nighttime Driving .....             | 4-6 |
| Mountain Driving .....              | 4-6 |
| Campsite Selection .....            | 4-6 |
| Leveling .....                      | 4-6 |

---

|   |      |  |          |
|---|------|--|----------|
| Effects of Prolong Occupancy .....      | 4-7  | Water Drain Valves .....               | 7-5      |
| Humidity and Condensation .....         | 4-7  | Utility Light .....                    | 7-6      |
| <b>SECTION 5: LP GAS SYSTEM</b>         |      | <b>SECTION 8: APPLIANCES AND</b>       |          |
| LP Gas Supply .....                     | 5-1  | <b>INTERIOR FEATURES</b>               |          |
| Safe Use of LP Gas System .....         | 5-1  | Refrigerators & Ice Makers .....       | 8-1, 8-4 |
| How LP Gas Works .....                  | 5-1  | Range and Oven.....                    | 8-8      |
| Selecting Fuel Types.....               | 5-1  | Microwave Oven.....                    | 8-9      |
| LP Tank System.....                     | 5-2  | Dishwasher .....                       | 8-9      |
| Refilling Tank.....                     | 5-2  | Washer-Dryer.....                      | 8-9      |
| Air in the LP Gas Tank.....             | 5-3  | Range Hood .....                       | 8-9      |
| Traveling with LP Gas.....              | 5-3  | Monitor Panel .....                    | 8-10     |
| Regulator.....                          | 5-3  | Tank Capacities.....                   | 8-10     |
| LP Gas Leaks.....                       | 5-4  | LP Gas Level .....                     | 8-10     |
| Winter Use of LP Gas.....               | 5-5  | Water Pump Switch .....                | 8-10     |
| <b>SECTION 6: ELECTRICAL SYSTEMS</b>    |      | Battery Conditioner Meter.....         | 8-10     |
| 110-Volt AC System.....                 | 6-1  | Water Heater.....                      | 8-11     |
| External Power Cord (Shoreline).....    | 6-1  | Water Heater By-Pass Valve .....       | 8-12     |
| Air Conditioner Power Switch.....       | 6-2  | Motor Aid Water Heater .....           | 8-12     |
| Power Control Center (Converter).....   | 6-3  | LP Gas Furnace.....                    | 8-12     |
| 110-Volt Circuit Breakers.....          | 6-4  | Thermostat .....                       | 8-13     |
| Charging Section.....                   | 6-4  | Central Air Conditioner .....          | 8-14     |
| Thermal Overload Protector .....        | 6-4  | Air Conditioner Filter .....           | 8-15     |
| 110-Volt Receptacles (Outlets).....     | 6-5  | TV Antenna.....                        | 8-15     |
| Ground Fault Circuit Interrupter        |      | TV Signal Amplifier .....              | 8-16     |
| (GFCI).....                             | 6-5  | Satellite System.....                  | 8-16     |
| Auxiliary 110-Volt Generator            |      | Video Control Center.....              | 8-17     |
| Operating Instructions.....             | 6-5  | DC-AC Electrical Voltage Inverter .... | 8-17     |
| 12-Volt DC System.....                  | 6-8  | Exterior Entertainment Center .....    | 8-17     |
| 12-Volt Fuses and Circuit Breakers..... | 6-8  | Cable TV Hook-Up .....                 | 8-17     |
| Solar Charger Panel .....               | 6-9  | Vacuum Cleaner .....                   | 8-18     |
| Battery Information.....                | 6-9  | Sleeping Facilities                    |          |
| Automotive (Starting) Battery .....     | 6-9  | Couch-Bed Conversion.....              | 8-19     |
| Coach Batteries.....                    | 6-9  | Fresh Water Toilet .....               | 8-19     |
| Battery Storage and Maintenance .....   | 6-10 | Power Roof Vent .....                  | 8-20     |
| Trailer Wiring Connector.....           | 6-11 | Slider Windows.....                    | 8-21     |
| <b>SECTION 7: PLUMBING SYSTEMS</b>      |      | <b>SECTION 9: CARE AND MAINTENANCE</b> |          |
| Fresh Water System .....                | 7-1  | Roof .....                             | 9-1      |
| Filling Water Tank.....                 | 7-1  | Underbody .....                        | 9-1      |
| Fresh Water Tank Capacity .....         | 7-1  | Exterior .....                         | 9-1      |
| Water Pump .....                        | 7-1  | Stripes and Decals, care of.....       | 9-1      |
| Water Pump Switch .....                 | 7-2  | Interior Maintenance                   |          |
| Disinfection of Water Tank .....        | 7-3  | Upholstery, Carpeting and              |          |
| External (City Water) Connector.....    | 7-3  | Draperies.....                         | 9-2, 9-3 |
| Shower Hose Vaccum Breaker .....        | 7-4  | Cabinets .....                         | 9-3      |
| Exterior Faucet.....                    | 7-4  | Tables and Countertops .....           | 9-3      |
| Drainage System (Waste) .....           | 7-4  | Vinyl Wallboard .....                  | 9-3      |
| Dumping Holding Tanks .....             | 7-4  | Stainless Steel Sink.....              | 9-3      |
| Using On-Site Sewer Hook-Ups.....       | 7-5  | Bathroom .....                         | 9-3      |

|                                       |              |
|---------------------------------------|--------------|
| Doors and Windows.....                | 9-4          |
| <b>Vehicle Maintenance</b>            |              |
| Chassis Service and Maintenance.....  | 9-4          |
| Engine Access.....                    | 9-4          |
| Diesel Fuel/Water Separator.....      | 9-5          |
| Engine Cooling System .....           | 9-5          |
| Tires .....                           | 9-5          |
| Suspension Alignment and Tire         |              |
| Balance.....                          | 9-6          |
| Windshield Washers and Wipers.....    | 9-6          |
| Lights .....                          | 9-6          |
| Automotive 12-Volt Circuit Breakers   | 9-6          |
| <b>SECTION 10: STORING YOUR MOTOR</b> |              |
| <b>HOME</b>                           |              |
| Preparing Vehicle for Storage.....    | 10-1         |
| Cold Weather Storage                  |              |
| (Winterizing).....                    | 10-1 to 10-3 |
| Removal from Storage .....            | 10-4         |
| RV Antifreeze Winterization Systems   | 10-5         |

---



Congratulations on the purchase of your new Luxor motor home, which has been carefully designed, engineered and quality built by Winnebago Industries, Inc.

### **OPERATOR'S MANUAL**

Please read this operator's manual thoroughly. It was prepared in order to provide you with information necessary to properly and safely operate your new motor home.

This manual describes those instruments, controls and instructions which are unique to this motor home. For information regarding all other equipment, controls and instructions not described herein, we urge you to read the "Chassis Operating Guide" and the equipment manufacturer's information provided in your "Motor Home Operation Manual".

This manual should be kept in the vehicle at all times for personal reference. The operator's manual, motor home operation manual and chassis operating guide are to be considered permanent components of this vehicle. They should remain in the vehicle when sold to provide the next owner with important safety, operating and maintenance information.

*NOTE: The descriptions, illustrations, and specifications in this manual were correct at the time of printing. We reserve the right to change specifications or design without notice, and without incurring obligation to install the same on products previously manufactured.*

### **FREIGHTLINER CHASSIS OPERATING GUIDE**

Throughout this manual, frequent reference is made to the vehicle chassis operating guide. The chassis guide is the operator's manual provided by Freightliner, the manufacturer of the chassis on which this motor home is built. Consult the chassis guide for operating safety and maintenance instructions pertaining to the chassis section of the motor home.

### **CUMMINS DIESEL ENGINE MANUAL**

The diesel engine in your Luxor is built by the respected Cummins Engine Company. Consult the Cummins manual for information on all engine related topics such as engine maintenance, fluid capacities and replacement filters, etc.

### **MOTOR HOME OPERATION MANUAL (Binder)**

Your Motor Home Operation Manual contains information supplied by manufacturers of individual appliances and equipment installed in your motor home.

Consult this information regarding the operation and care of appliances, accessories and special equipment.

### **OPTIONS AND EQUIPMENT**

Some equipment described in this manual may not apply to your coach.

### **BEFORE DRIVING**

Before sitting in the driver's seat, always check around your vehicle to be sure you have proper clearance for maneuvering. If necessary, have a passenger help guide you out of a difficult parking space.

Although your coach features automotive conveniences like power steering and power brakes, driving a motor home is different from driving a car. A motor home is larger and heavier than an automobile, so it requires more stopping and passing distance, and more parking and maneuvering space than does a car.

Always be aware of the size of your motor home. The added height of TV antennas or luggage boxes may cause clearance problems around some tunnels, canopies and hanging signs. Know the height of your coach so you can observe posted clearance limits. Also, remember that some bridges, old ones in particular, may not support the weight of your motor home. Know

the weight of your unit and observe any posted weight limits.

Remember: Always use your seat belt and be sure your passengers do so as well. We also advise making frequent rest stops while traveling to relieve stress on yourself, your passengers and your vehicle.

## SERVICE AND ASSISTANCE

Your Luxor dealer will be glad to provide any additional information you need, as well as answer any questions you might have about operating the equipment in your motor home. When it comes to service, remember that your Luxor dealer knows your vehicle best and is interested in your satisfaction. Your dealer will provide quality maintenance and any other assistance that you may require during your ownership of this vehicle.

If you need warranty repairs while traveling, however you may take your motor home to any Winnebago or Itasca dealership and they will assist you.

## WARRANTY

Your new Luxor is covered by a factory warranty against defects in material and workmanship. This warranty should be validated immediately and returned to the factory by your dealer. For additional information, see your "New Vehicle Limited Warranty" included with this vehicle.

## DRINKING AND DRIVING

Winnebago Industries supports the recommendations of the Presidential Commission on Drunk Driving.

- Exercise your good judgment and encourage others to do the same.
- Know the legal limits and do not exceed them.
- Also know your personal limits, which may be lower than the legal limits.
- Should you ever exceed your limits, find alternative transportation; call a cab, ask a friend to drive you home or call a family member to come and get you.

The presence of alcohol in significant levels in the blood increases the probability that the driver will be involved in an accident.

## REPORTING SAFETY DEFECTS

If you believe that your vehicle has a defect which could cause a crash or could cause injury or death, you should immediately inform the National Highway Traffic Safety Administration (NHTSA) in addition to notifying Winnebago Industries, Inc.

If NHTSA receives similar complaints, it may open an investigation, and if it finds that a safety defect exists in a group of vehicles, it may order a recall and remedy campaign. However, NHTSA cannot become involved in individual problems between you, your dealer, or Winnebago Industries.

To contact NHTSA, you may either call the Auto Safety Hotline toll-free at 1-800-424-9393 (or 366-0123 in Washington, D.C. area) or write to: NHTSA, U.S. Department of Transportation, Washington, D.C. 20590. You can also obtain other information about motor vehicle safety from the Hotline.

### VEHICLE CERTIFICATION LABEL

This label contains vehicle identification and other important reference information. The vehicle certification label is located on the sidewall to

the left of the steering wheel, or on the driver's door. Never remove or destroy this label.

|   |  |  |  |
|---|--|--|--|
| <b>MANUFACTURED BY</b><br>                             |  | <b>INCOMPLETE VEHICLE MANUFACTURED BY</b> ① <b>MOTOR CORP.</b> |  |
| <b>③</b><br><b>GAWR:</b>  |  | <b>MONTH AND YEAR OF MANUFACTURE:</b> ②                        |  |
| <b>FRT</b> _____ <b>LB</b> _____ <b>KG</b>  |  | <b>GVWR</b> ④ <b>LB</b> _____ <b>KG</b>                        |  |
| <b>RR.</b> ⑤ <b>LB</b> _____ <b>KG</b>  |  | <b>SUITABLE TIRE AND RIM CHOICE</b>                            |  |
| <b>TIRE</b> _____   |  | <b>RIM</b> _____   |  |
| <b>PSI</b> _____ <b>KPA</b> _____   |  | <b>COLD INFLATION PRESSURE</b>                                 |  |
| <b>⑥</b> _____  |  | <b>⑦</b> _____   |  |
| <b>⑧</b> <b>PSI</b> _____ <b>KPA</b> _____  |  | <b>⑨</b>   |  |
| <b>THIS VEHICLE CONFORMS TO ALL APPLICABLE FEDERAL MOTOR VEHICLE SAFETY STANDARDS IN EFFECT ON THE DATE OF MANUFACTURE SHOWN ABOVE.</b> |  |  |  |
| <b>SERIAL NO.</b> ⑩ _____   |  | <b>VIN</b> ⑪ _____   |  |
| <b>TYPE</b> ⑫ _____   |  | <b>MODEL</b> ⑬ _____ <b>COLOR</b> ⑭ _____                      |  |

#### EXPLANATION OF DATA

1. Chassis manufacturer.
2. Chassis manufacture date.
3. Month and year of manufacture at Winnebago Industries.
4. Gross Vehicle Weight Rating: Total permissible weight of the vehicle, including driver, passengers, total cargo carried (including all liquids) and equipped with all options.
5. Gross Axle Weight Rating: Total permissible weight allowed for the front, intermediate\* and rear axles (listed in pounds and kilograms).
6. Suitable Tire Choice: Tires recommended to meet handling and safety requirements. When replacing any of the tires on your vehicle, always replace with a tire that meets these specifications.
7. Suitable Rim Choice: Wheel rims recommended to meet handling and safety requirements. When replacing any of the rims on your vehicle, always replace with a rim that meets these specifications.
8. Cold Inflation Pressure: Inflation pressures recommended (while Cold) for the tires originally equipped on your vehicle. These pressure levels must be maintained to assure proper handling, safety and fuel economy.
9. Intermediate\* and Rear Axle Wheel Configuration: Single or Dual.
10. Serial Number: This is the serial number assigned to the completed vehicle by Winnebago Industries.
11. Vehicle Identification Number (VIN): This number identifies the chassis on which the motor home is built.
12. Type: States the NHTSA designated usage classification for your motor home. MPV signifies a Multi-purpose Passenger Vehicle.
13. Model: Lists the Winnebago product model number of your vehicle.
14. Color: Signifies the color code number of the decor used throughout the vehicle. This number is necessary for ordering replacement cushions, curtains, carpet, etc.

\*Intermediate (INT) data applies only to Class-A models equipped with tag axle.

## EXTERIOR FEATURE IDENTIFICATION

Composite model shown for illustration purposes only.  
Actual locations of features depends on coach model and options.

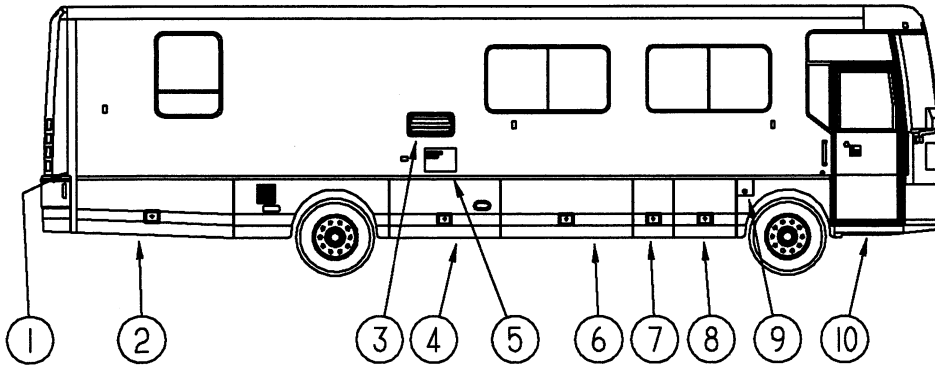

- 1. Engine Fluid Service Access
- 2. Battery Storage Compartment\*
- 3. Refrigerator Service Access
- 4. Exterior Entertainment Center/Storage
- 5. Water Heater Service Access\*\*

- 6. Pass-Thru Storage Compartments
- 7. LP Gas Tank Compartment
- 8. Storage Compartment
- 9. Diesel Fuel Fill
- 10. Entrance Door & Power Step

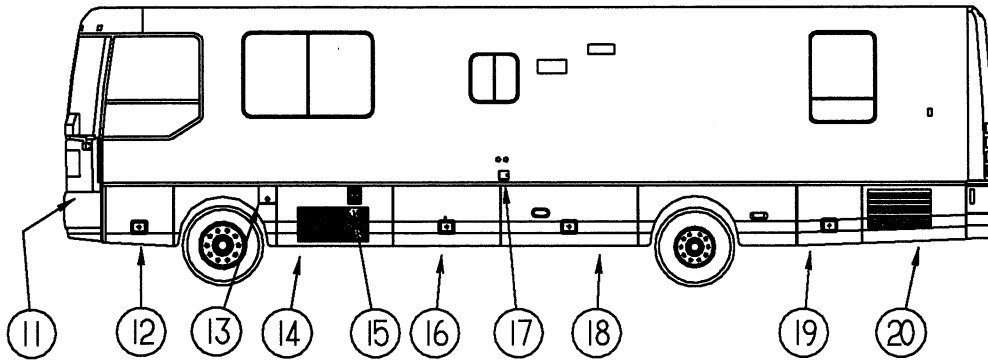

- 11. Hood/Auxiliary Generator Compartment
- 12. Storage Compartment
- 13. Diesel Fuel Fill
- 14. Central A/C Service Access Compartment
- 15. Furnace Service Access Compartment\*\*

- 16. Pass-Thru Storage Compartment
- 17. Fresh Water Tank Gravity Fill
- 18. Utility System Compartment
- 19. Storage Compartment††
- 20. A/C Condenser Service Access

NOTE: Some equipment shown may be optional.

\*Also contains diesel fuel filter/water separator.

\*\* Be careful. Surface may become hot while using appliance or equipment.

†Contains water center, holding tank valves, exterior faucet, TV/phone hookups, water line drain valves and shoreline cord connection.

††Also contains engine block heater connection and access to air suspension solenoid valves.



Read and understand all instructions and precautions in this manual before operating your new motor home. Throughout this manual, certain items are labeled NOTE, CAUTION and WARNING. These terms alert you to precautions that can involve risk to your vehicle or to your personal safety. Read and follow them carefully.

*NOTE: Indicate special points of information.*

**CAUTION**

Indicates that a failure to observe can cause damage to vehicle or equipment.

**WARNING**

This symbol is used to alert you to precautions that involve your personal safety as well as vehicle damage. Read and follow them carefully.

Listed below are some safety precautions that must be adhered to. These precautions as well as others that involve damage to equipment are also listed in the appropriate areas in this manual.

### GENERAL WARNINGS

- Only seats equipped with seat belts are to be occupied while the vehicle is moving.
- Make sure all passengers have seat belts fastened in a low and snug position so the force exerted by the belt in a collision will be spread across the strong hip area. Pregnant women should wear a lap-shoulder belt whenever possible, with the lap belt portion worn low and snug throughout the pregnancy.
- Never let passengers stand or kneel on seats while the vehicle is moving.
- Sleeping facilities are not to be utilized while vehicle is moving.
- Examine the escape window and be familiar with its operation, but do not use except in an emergency.
- Inspect the fire extinguisher monthly for proper charge and operating condition. This should also be done before beginning a vacation or any extended trip.

### DRIVING

- Do not attempt to adjust the driver's seat while the vehicle is moving.
- Do not adjust tilt steering in a moving vehicle.
- Do not operate the cruise control on icy or extremely wet roads, winding roads, in heavy traffic, or in any other traffic situation where a constant speed cannot be maintained.
- Use care when accelerating or decelerating on a slippery surface. Abrupt speed changes can cause skidding and loss of control.
- Driving through water deep enough to wet the brakes may affect stopping distance or cause the vehicle to pull to one side. Check brake operation in a safe area to be sure they have not been affected. Never operate any vehicle if a difference in braking efficiency is noticeable.
- Adverse weather conditions and extremes in terrain may affect handling and/or performance of your vehicle. Refer to your chassis manual for related information.

### FUEL & LP GAS

- All pilot lights must be extinguished and appliances turned off while refilling the fuel tank or LP tank.
- Never smoke while refilling vehicle fuel tank or LP gas tank.

**SECTION 1**  
**SAFETY PRECAUTIONS**

**L U X O R**

- Avoid inhaling exhaust gases produced by burned gasoline, diesel fuel or LP gas in items such as the range, chassis engine, generator engine, refrigerator, furnace and water heater. They contain carbon monoxide, which is an odorless, colorless and poisonous gas.
- Do not bring or store LP gas containers, gasoline or other flammable liquids inside the vehicle because a fire or explosion may result. LP gas containers are equipped with safety valves which relieve excessive pressure by discharging gas to the atmosphere.
- Do not alter the LP gas system at any time or in any way.
- Do not fill LP gas container(s) above 80 percent of capacity. Overfilling the LP gas container can result in uncontrolled gas flow which can cause fire or explosion. A properly filled container will contain approximately 80 percent of its volume as liquid LP gas.
- Never use an open flame to test for LP gas leaks. Replace all protective covers and caps on LP system after filling. Make sure valve is closed and door latched securely.
- Never connect natural gas to the LP gas system.
- When lighting range burners do not turn burner controls to "On" and allow gas to escape before lighting match.
- Portable fuel-burning equipment, including wood and charcoal grills and stoves, shall not be used inside the recreational vehicle. The use of this equipment inside the recreational vehicle may cause fires or asphyxiation.
- LP gas regulators must always be installed with the diaphragm vent facing downward. Regulators are equipped with a protective cover. Make sure that the regulator vent faces downward and that the cover is kept in place to minimize vent blockage which could result in excessive gas pressure causing fire or explosion.

- The following warning label is located in the cooking area to remind you to provide an adequate supply of fresh air for combustion.

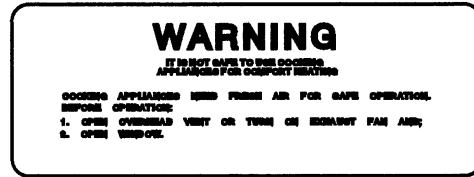

Unlike large homes, the oxygen supply inside a recreational vehicle is limited due to its size. To avoid danger of asphyxiation, provide proper ventilation when using the gas rangetop or gas oven. It is especially important that the gas oven and range top not be used for comfort heating. Danger of asphyxiation is greater when these appliances are used for long periods of time.

**LP GAS LEAKS**

The following label is located in the vehicle near the range area. If you smell gas within the vehicle, quickly and carefully perform the procedures listed.

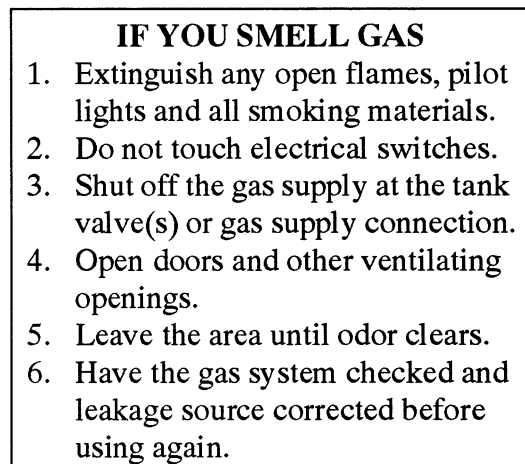

**LP GAS ALARM**

Your coach is equipped with an LP gas detector which sounds an alarm if an unsafe amount of LP gas is present inside the coach. Because LP gas is heavier than air, the detector is located on a cabinet face near the floor of the coach.

A green light on the face of the alarm shows when the unit is active. The red button is used to reset the alarm.

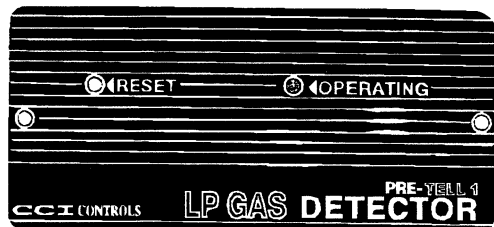

### If The Alarm Sounds

If the alarm sounds, do not touch any electrical switches. Immediately turn off the main LP tank valve and all LP appliances, open all windows and roof vents, and leave the coach until the alarm stops sounding.

If the alarm keeps sounding at regular intervals, a leak may be present. Contact your dealer or an LP gas service center to have the problem corrected before using the LP system again.

#### WARNING

Never use an open flame to test for gas leaks. When testing for gas line leaks with a soapy water solution, DO NOT use a detergent containing ammonia or chlorine. These substances may generate a chemical reaction causing corrosion to gas lines, resulting in dangerous leak conditions.

### Power Connection

The gas alarm is powered by the coach batteries. If the battery cable is disconnected from the batteries, auxiliary battery switch is shut off, or the fuse is blown, the alarm will not work. The LP gas alarm fuse is located on the automotive fuse panel shown on page 9-7.

Because the LP gas alarm is connected directly to the auxiliary battery, it is always drawing a small amount of current. Even though this current draw is slight, it could drain the coach battery during storage periods of 30 days or longer. We

recommend turning the auxiliary battery switch off or disconnecting the battery cables from the auxiliary battery during extended storage periods to avoid discharge.

### Further Information

See the manufacturer's information entitled "Your LP Gas Detector" in the operations manual binder for further instructions on nuisance alarms and care and testing of the LP gas detector.

### ELECTRICAL

- Careless handling of electrical components can be fatal. Never touch or use electrical components or appliances while feet are bare, while hands are wet, or while standing in water or on wet ground.
- Improper grounding of the vehicle can cause personal injury. Do not plug the utility power cord into an outlet which is not grounded and do not adapt the plug to connect to a receptacle for which it is not designed.
- Do not attach an extension cord to the utility power cord.
- Be sure that all electrical appliances to be used contain 3-prong plugs for proper grounding.
- Avoid overloading electrical circuits. Replace fuses or circuit breakers with those of the same size and amperage rating only. Never use a higher rated fuse or breaker.
- Use caution when handling or working near electrical storage batteries. Always remove jewelry and wear protective clothing and eye covering. Avoid creating sparks.

### LOADING

- Store or secure all loose items inside the motor home before traveling.
- Be aware of GVWR, GAWR and individual load limit on each tire or set of duals. (See

“Loading the Vehicle” in Section 4.)

- Never load the motor home in excess of the gross vehicle weight rating or the gross axle weight rating for either axle.

## MAINTENANCE

- Do not remove the radiator cap while engine and radiator are still hot. Always check coolant level visually at the see-through coolant reservoir.
- Never get beneath a vehicle that is held up by a jack.
- Do not mix different construction types of tires on the vehicle such as radial, bias or belted tires, as vehicle handling may be affected. Replace tires with exact size, type and load range.
- Do not attempt to start the vehicle by hot wiring.

## FORMALDEHYDE INFORMATION

### WARNING

Some components in this vehicle contain formaldehyde based adhesives which may release formaldehyde fumes into the air for an unknown period of time until total dissipation occurs. Individuals who are allergic to formaldehyde gas fumes may experience irritation to eyes, ears, nose and throat. Reaction in infants may be more severe. Although long range effects are not well understood, testing to date has not revealed any serious health effects in humans at the level of emission from these products.

### IMPORTANT

To aid in dissipation, ventilate the vehicle by opening all windows and circulating the air with a fan.

## CARBON MONOXIDE WARNING

### WARNING

Avoid inhaling exhaust gases, as they contain carbon monoxide, which is a colorless, odorless and poisonous gas.

If you suspect that exhaust fumes are entering the passenger compartment, have the cause determined and corrected as soon as possible. If you must drive under these conditions, drive only with **ALL WINDOWS FULLY OPENED**.

The best protection against carbon monoxide entry into the vehicle body is a properly maintained engine exhaust and ventilation system. It is recommended that the exhaust system and body be inspected by a qualified motor home service center.

- Each time the vehicle is raised for an oil change.
- Whenever a change in the sound of the exhaust system is noticed.
- Whenever the exhaust system, underbody or rear of the vehicle is damaged.

To allow proper operation of the vehicle's ventilation system, keep front ventilation inlet grill clear of snow, leaves or other obstructions at all times. **DO NOT OCCUPY A PARKED VEHICLE WITH ENGINE RUNNING FOR AN EXTENDED PERIOD.**

Do not run engine in confined areas, such as a garage, except to move vehicle in or out of area. When vehicle is stopped in an **UNCONFINED** area with the engine running for any more than a short period, adjust heating or cooling system to force outside air into the vehicle as follows:

1. Set fan to medium or high speed and vent control to air.
2. On vehicles equipped with air conditioning, set fan to medium or high speed and set control to obtain maximum vent air.

Rear windows should be closed while driving to avoid drawing dangerous exhaust gases into the vehicle.

### CARBON MONOXIDE ALARM

If your coach is equipped with a carbon monoxide (CO) alarm, it will be located on the ceiling in the bedroom area.

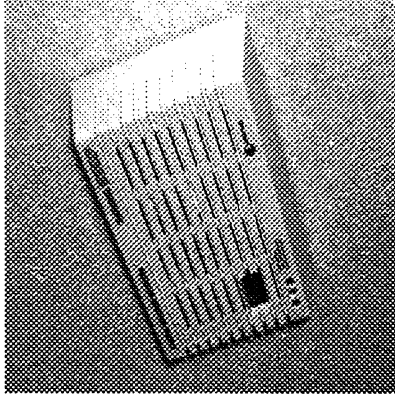

The CO alarm is powered by a battery/sensor pack and is designed to detect toxic carbon monoxide gas fumes resulting from incomplete combustion of fuel. It will detect CO gas from any combustion source such as the furnace, gas range/oven, water heater, refrigerator, chassis engine, and electric generator engine.

### FURTHER INFORMATION

Please read the information provided by the manufacturer, which is included in your Motor Home Operations Manual binder. It includes information on precautions, operational testing, and battery/sensor replacement.

### EMERGENCY EXITS

#### Emergency Exit Windows

Your motor home is equipped with an emergency exit window on the left (driver's) side of the bedroom which functions as an escape exit in an emergency situation.

#### WARNING

Use emergency window for emergency exit only. Do not test for proper operation.

Use care when exiting emergency window, as broken glass may be present in the exit area.

The side mounted escape window is secured by two red safety latches and can be opened by first releasing these two latches and then pushing outward on the lower part of the window. Identify which type of emergency exit window is in your vehicle.

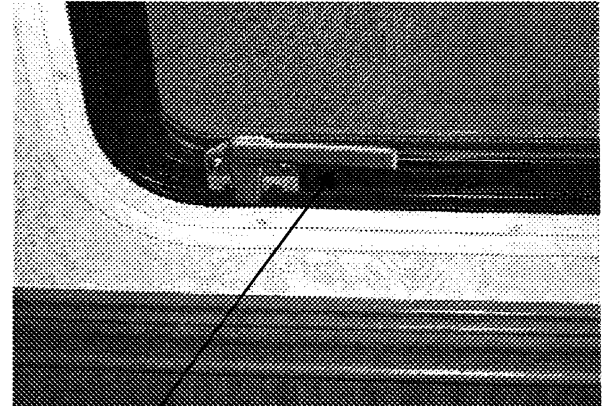

Lift Both Handles Up  
Push Out on Bottom

Instructions for removal are also located on a label on the glass for quick reference and for passengers who may not be familiar with the exit. Never remove or destroy this label.

### Using Slider Windows as Emergency Exits

Slider windows along the side of the motor home can also be used as emergency exits, should the need arise. To use the windows as exits, slide the window open, then slide the screen open.

### SAFETY DEVICES

#### Fire Extinguisher

A dry chemical fire extinguisher is located near the floor by the side entrance door.

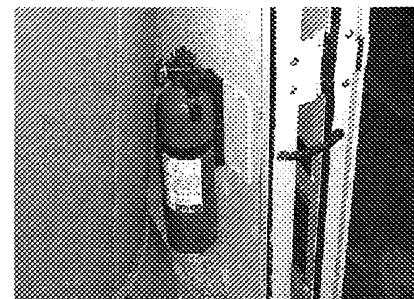

**SECTION 1**  
**SAFETY PRECAUTIONS**

**L U X O R**

We recommend that you become thoroughly familiar with the operating instructions displayed on the side of the fire extinguisher or in the information supplied in your Motor Home Operations Manual binder.

We also recommend that you inspect the fire extinguisher for proper charge at least once a month in accordance with National Fire Protection Association (NFPA) recommendations as stated on the label. If the charge is insufficient, the fire extinguisher must be replaced.

**WARNING**

Do not test the fire extinguisher by discharging it. Partial discharge can cause leakage of pressure or contents which would render the unit inoperative when needed. When using the fire extinguisher, aim the spray at the base of the fire.

2. Your smoke alarm will not work without power. Never remove the battery to quiet the alarm. When your smoke alarm “beeps” about once a minute the battery is weak. Install a new battery immediately. Be sure to use only batteries specified in manual or on unit. Test unit after installing a new battery.
3. Clean and vacuum the openings on your smoke alarm once a month. Do not open the smoke alarm or try to repair it. For replacement information see warranty in Owner’s Manual.
4. Smoke alarms have technical limitations and may not respond in all situations. FIRE PREVENTION is your best safeguard.

See your Motor Home Operation Manual binder for further information.

**SMOKE ALARM**

Your motor home is equipped with a smoke alarm located on the ceiling in the galley area. This alarm meets U.L. Standard 217 and NFPA Standard 74 for operation of smoke detection devices.

1. The smoke alarm should be tested for correct operation each time the vehicle is brought out of storage, before each trip, and at least once a week during motor home use. To test the electronics, firmly depress the button. To test that smoke reaches the sensor, blow smoke in a careful, fire-safe manner into your smoke alarm.

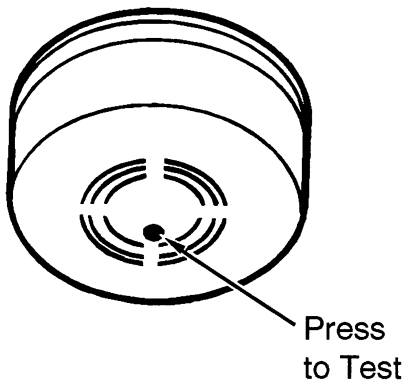

(See also Safety Precautions, Section 1 of this manual.)

*NOTE: See your Freightliner chassis operator's manual for information on starting the engine, operating the transmission, steering column controls descriptions of instrument gauges and other chassis related information.*

*Some items described in this section may be optional or unavailable on your coach.*

### BEFORE ENTERING YOUR VEHICLE

Before entering your vehicle, there are a few recommended procedures that will aid in your driving safety and equipment.

1. Be sure that the windows, mirrors and light lenses are clean and unobstructed.
2. Make sure all exterior lights operate properly.
3. Check tires for proper cold inflation pressures and inspect for any unusual wear.
4. Check wheel lug nuts for tightness.
5. Look beneath the vehicle for noticeable fluid leakage.
6. Check fluid levels and fill if necessary. This includes engine oil, transmission fluid, coolant, brake fluid, power steering fluid and windshield washer solvent.

#### WARNING

The engine should be shut off unless specifically required for a certain procedure.

Freightliner: The transmission must be in N (Neutral) and park brake applied while performing any checks or adjustments.

7. Unhook and store sewer and water supply hoses.
8. Retract step.
9. Be sure that all of your cargo is secured in event of a sudden stop or an accident.
10. Check around your vehicle in all directions to assure that you have proper clearance.
11. Lower TV antenna.
12. Disconnect and store shoreline.

#### WARNING

Before driving your vehicle, be sure you have read the entire operator's manual and that you understand your vehicle's equipment completely and how to use the equipment safely.

### BEFORE DRIVING YOUR VEHICLE

Before preparing to drive your vehicle, here are a few recommended procedures that will add to your driving safety and enjoyment.

1. Be sure that you adjust the interior and exterior rear view mirrors to your driving preference.
2. Adjust the driver's seat for proper distance from foot pedals and steering wheel to allow for safety and ease in controlling your vehicle.
3. Place front seats in the forward facing position.
4. Be sure to fasten all safety belts to fit you comfortably, but tight enough to obtain the full safety of the belts.
5. Make sure all doors are completely shut and locked. When the doors are shut and locked, there is less chance of the doors flying open in event of an accident. It also prevents unintentional opening of doors and keeps intruders out of your vehicle.
6. Check to see that all gauges are operating properly.
7. Check the fuel level in the vehicle.

8. Be certain that the fire extinguisher is fully charged and secure in its mounting bracket.

**CAUTION**

Be sure hood and all compartment doors are latched securely before driving vehicle

**KEYS**

Your motor home is supplied with several sets of keys. In addition to the chassis manufacturer's ignition key, you receive keys for front doors, entrance door, and exterior compartment doors.

Each set of keys has an identification number, either a small metal tag or stamped into the key head. Record these numbers and keep them in a safe place. In case keys are lost or stolen, your dealer or a locksmith can provide you with duplicate keys or modify the locks.

**FUEL SELECTION**

Refer to your Freightliner chassis operating guide for the manufacturer's recommendations on proper fuel selection.

**Winter Fuel Waxing and Anti-Gel Additives**

In sub-freezing temperatures, #2 diesel fuel can form small wax crystals that become trapped in the fuel filter and block the fuel flow to the engine, causing it to stall out. At sub-zero temperatures, the fuel can congeal and turn "slushy". If this happens, the only remedy is to have the vehicle towed into a heated facility to allow the fuel to warm up and become fully liquid again.

During winter time, most truck stops and reputable filling stations have winter blend diesel fuels available that are less susceptible to waxing.

There are also commercially available products, typically called anti-gel additives, to add to diesel fuel while filling the tank to inhibit wax formation in freezing temperatures.

Consult your Freightliner chassis guide or Cummins engine guide for more information on fuel requirements and additives.

**FILLING THE FUEL TANK**

Diesel fuel, especially #2 grade, can foam up while being pumped into the tank. Sometimes this foam can cause the pump nozzle to shut off before the tank is actually full. Allow the foam to settle then resume filling at a slower flow rate until the tank is full.

**Fuel Tank Capacity:** 100 gals. diesel

**STARTING AND STOPPING ENGINE**

Refer to your Freightliner chassis operating guide for the manufacturer's recommendations on starting and stopping the engine.

See also "Engine Block Heater" elsewhere in this section.

**Cold Weather Starting:** Please note the following cold weather starting precautions. These labels are also located in appropriate areas of the coach. Failure to follow these precautions could cause serious damage to your diesel engine.



**ENGINE BLOCK HEATER**

Your coach is equipped with an engine block heater to assist starting in freezing temperatures. The power cord is located in the rear cargo compartment on the driver side of the coach. When plugged into the receptacle, the heater is connected to both the shoreline and the auxiliary generator, so extension cords are not needed under most circumstances. The power switch is on the forward bedroom wall on the driver's side of the coach.



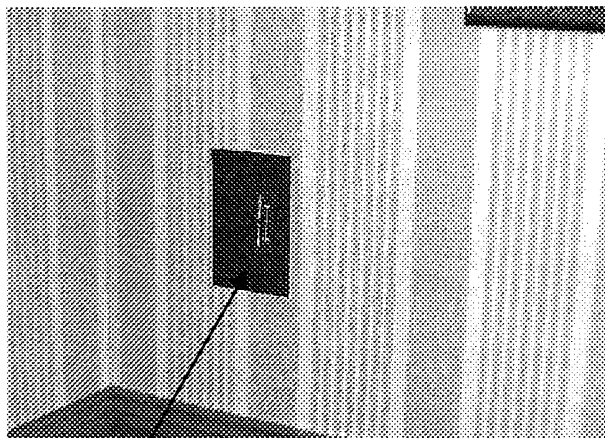

Engine Block Heater Switch  
on forward left bedroom wall

### To Use the Engine Heater

With the shoreline cord plugged into a shoreline hookup, turn on the engine heater power switch on the forward bedroom wall on the driver's side of the coach.

If a shoreline hookup is not available, just start the auxiliary generator to provide power to the engine heater.

**REMEMBER!** Turn the engine heater switch off after starting the engine. The heater will keep operating for as long as it is supplied with electricity. If the switch is left on, the engine heater will come on each time you hook up the shoreline cord or start the generator.

### PARKING BRAKE

The parking brakes are applied by pulling outward on the large black knob on the dash to the left of the ignition switch. Push the knob in to re-

lease the brakes.

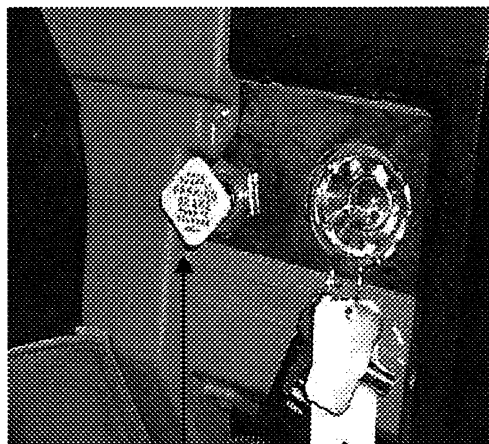

Parking Brake Knob

Use the parking brakes whenever the vehicle is parked. Never try to drive the vehicle with the park brake applied. This can cause excessive wear on the brakes and may damage the transmission.

*NOTE: It is normal to hear an occasional burst of air pressure from the rear of the vehicle. This is an automatic moisture purging feature of the air brake system. See the Brakes section of your Freightliner chassis manual for instructions on periodic draining of brake air tank.*

### JACOBS<sup>®</sup> EXTARDER<sup>™</sup> EXHAUST BRAKING SYSTEM ("Jake Brake") - Optional

The Jacobs Extarder is an engine compression retarder that generates "braking" power by controlled restriction of the engine's exhaust gas flow. When the exhaust brake is activated, a valve closes off the engine's exhaust causing the exhaust back pressure to increase, which causes the vehicle to slow down. This increased back pressure would normally stop the engine except the forward momentum of the vehicle keeps the drivetrain and the engine turning. This controlled back pressure helps to regulate a vehicle's downhill speed, such as on mountainous or hilly roads. It also provides "braking" on level or near-level roads.

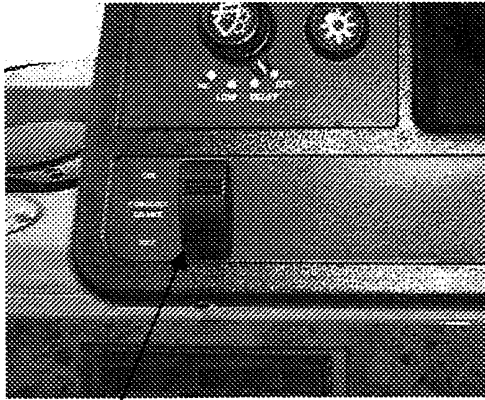

Exhaust Brake Switch

**To use the Extarder™ Brake:** Press the switch on the lower left side of the dash. The switch must be held ON to activate the exhaust brake system. When the switch is released, the exhaust brake is OFF. See your Jacobs Extarder user guide in the blue binder for complete operating instructions and precautions.

### HAZARD WARNING LIGHTS

The hazard warning flasher switch is located on the underside of the steering column near the signal/cruise lever. Pull the switch button outward from the column to activate the flashers. To cancel flashers, push the switch button inward toward the column. See also Section 3 for further operating information.

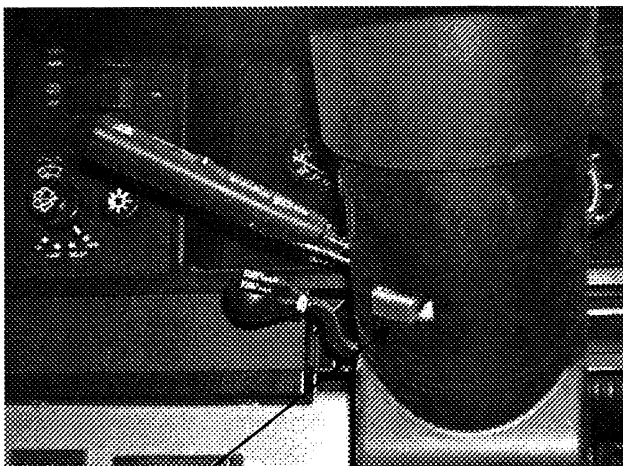

Hazard Light Switch  
Pull On/Push Off

### ENTRANCE DOOR LOCK AND HANDLE

The entrance door may be opened from outside the vehicle by pulling the door handle outward. To open the door from inside, pull outward on the door handle. When the door is locked, neither the inside nor the outside door handle can be operated. It can be locked and unlocked from the outside of the vehicle by inserting the key into the lock and turning.

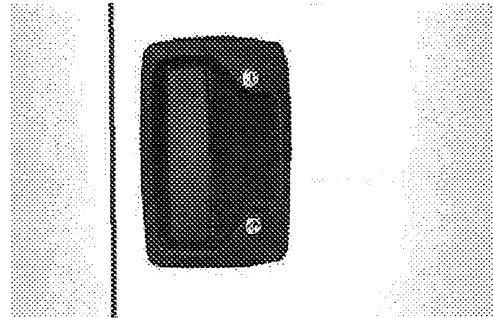

Entrance Door Handle - Outside

To lock the door from inside, rotate the lock levers as indicated. The deadbolt lock is for added security and should be used as a security night lock.

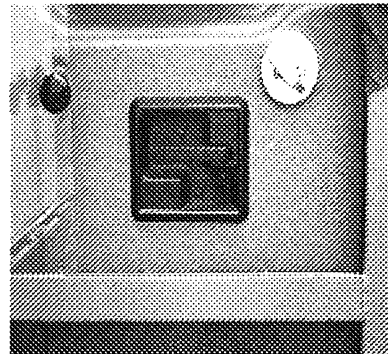

Entrance Door Handle - Inside

Lubricate the locks periodically with graphite to maintain good working condition.

#### CAUTION

When releasing security night lock, be sure to retract bolt before opening door latch to prevent drag on bolt pin. Instruct all passengers in operation of this door catch system as well as emergency exit window.

## Entrance Door Prop Latch

The entrance door is equipped with a Pos-A-Loc® door prop mechanism which locks it rigidly in the open position while in use.

To close the entrance door, pull either inner or outer door handle to unlatch the prop latch mechanism before attempting to close the door.

*IMPORTANT: The entrance door locks in the open position. Do not try to force the door shut without operating either inside or outside door handle. Forcing the door shut can damage the door prop latch mechanism.*

Please make passengers and guests aware of this feature to avoid damage to the door.

## POWER DOOR LOCKS - with Keyless Remote Entry System

The power door locks control the side entrance door.

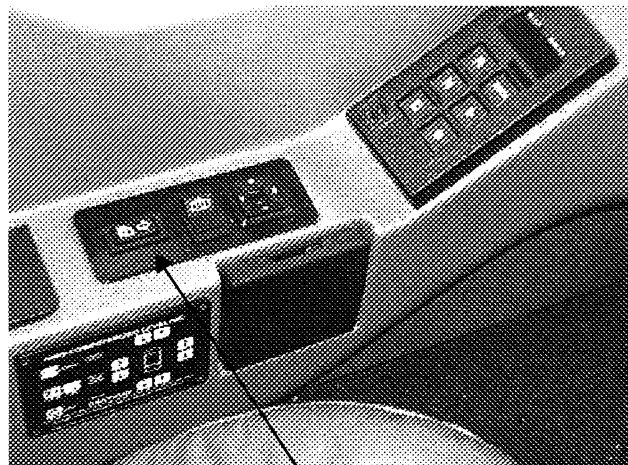

Power Door Locks

## POWER WINDOW - Driver Side Only

The driver door is equipped with a power operated window. The switch is located on the driver door armrest area.

## Keyless Remote Entry System

The keyless entry is a remote control power door lock system. This feature allows you to unlock or lock your doors from outside the coach

without using a key.

**Lock:** When you leave the coach, simply press either one of the buttons on the remote transmitter attached to your key ring. The cab door and the side entrance door will lock at the same time. Your parking lights will flash once to tell you that the doors have been locked.

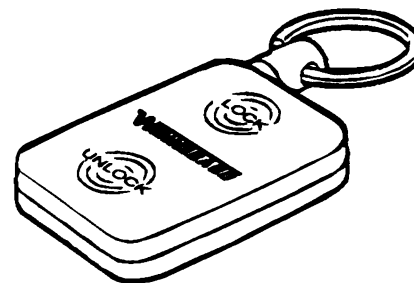

Keyless Remote Unit

**Unlock:** When you return to the coach, press either one of the buttons on the transmitter and the doors will unlock. Your parking lights will flash twice to tell you that the doors are being unlocked. The porch light will also come on for 20 seconds to light your way to the coach.

*NOTE: For maximum range when transmitting, point the brass key ring of the remote unit toward the coach.*

**Programming Remote Units:** If the chassis battery becomes dead or is disconnected, the keyless lock system's control unit will "forget" the signal code from the remote units. When the battery is reconnected, the parking lights will flash on and off to tell you that the control unit is ready to receive programming signals from the remote units.

With one transmitter, press the top button, then the bottom button. With the other transmitter, press the top button, then the bottom button, then the top one again. This sequence will fill the five memory locations in the control unit and the system will again work properly.

**If You Lose a Remote:** Your dealer can order replacement remote keyring transmitter if you should lose one, or if you simply want a spare.

When you get a new remote, your dealer must program the master control unit in the coach to receive the signal code from the new remote unit.

**Replacing Batteries in Remote Units:** The battery should last for one year under normal use. When the transmitting range of the remote unit drops, the battery is probably becoming weak.

1. Remove remote unit from key ring and lay face down.
2. Remove screws from rear corners of case.
3. Open transmitter case. Do not lose key ring swivel. It is not fastened to case.
4. Remove old battery and insert new battery in same direction (+/-) as old battery.
5. Close case and replace case screws.

The compact 12 volt battery used in these units is available at most electronic shops and camera shops.

Recommended 12 volt battery:  
Gold Peak GP27A  
Bronica B-1 or suitable equivalent

*NOTE: If a 12 volt battery is not available, you may "stack" eight (8) 1.5 volt watch (button) batteries as a substitute. Be sure the batteries all face the same direction. It may help to wrap tape around the stack to hold the batteries together for easier installation.*

Recommended watch batteries:

|        |      |
|--------|------|
| #392   | G-3  |
| RW-47  | 192  |
| SR-41W | 8009 |
| 547    |      |

*NOTE: Keys should always be removed when leaving the vehicle. Since doors can be locked without keys, make sure they have been removed from the ignition before locking the driver's compartment.*

### ENTRANCE STEP - Powered

The electric entrance steps will extend automatically when you open the entrance door, and retract when you close the door. You can also switch the step power off if you want to keep the step extended while parked at a campsite, when you exit and enter the coach frequently. This saves wear on the step mechanism and conserves coach battery power.

The step power switch is located on the entry switch panel to the left of the doorway as you enter the coach. If you turn the switch off while the steps are extended, they will remain extended until you turn the switch back on. The steps will extend when the door is opened even if the switch is off. **The step will not retract, however, unless the switch is on.**

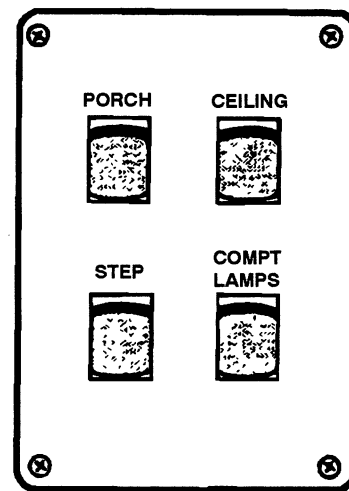

If the steps will not extend or retract, check the step power switch.

This step has a unique safety retraction feature that prevents damage to the step by driving off with the step extended.

Even if the step is extended with the step switch turned off and the entrance door closed, the step will automatically retract when the coach engine is started.

See the power step owner's manual in your Motor Home Operations Manual for operating instructions and additional information.

#### WARNING

Do not use steps unless they are fully extended.

### CAUTION

Always remember to retract the entrance steps before traveling or moving the vehicle.

### STEPWELL COVER

The stepwell cover can be extended to cover the stepwell area and increase usable floor space in the front of the coach while the entrance door is not in use.

Press and release the Step Cover switch on the passenger sidewall armrest. The step will extend or retract fully. It is not necessary to hold the switch down while the cover is extending or retracting.

The step cover movement is powered by air pressure from the air brake/horn system. If system air pressure drops below 60 psi (shown on gauge in lower center of instrument panel), the step will not operate properly. If system pressure is insufficient to retract step, use the Manual Air Release Valve as described below.

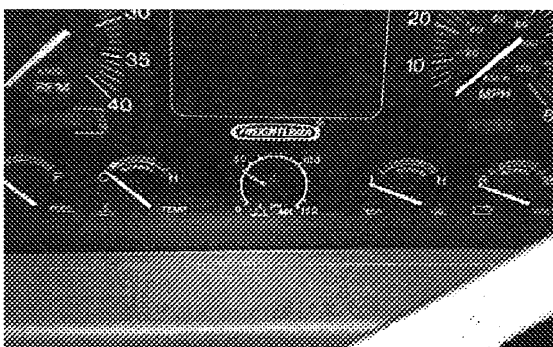

### CAUTION

Stay clear of entrance step area when stepwell is being extended or retracted. When entering or exiting, loose clothing may catch on components of the mechanism. Personal injury and/or property damage may result.

### Stepwell Cover Manual Air Release Valve:

Rotate the knob so it points to OPEN to bypass air pressure to the step mechanism. This allows

you to stop the travel of the step cover while extending, if necessary. It also allows you to manually push the step cover back into the storage position for use of the step in event of insufficient system air pressure.

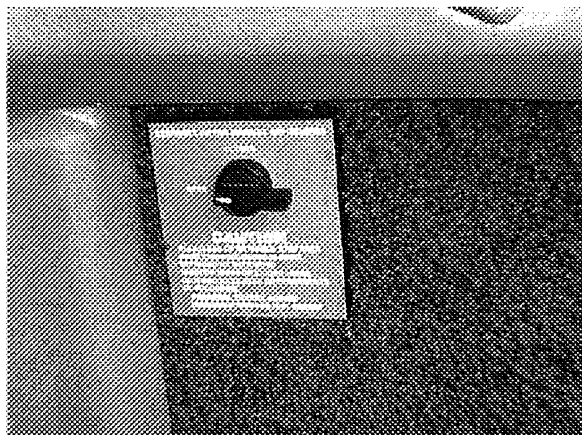

Rotate the knob pointer back to the CLOSED position to resume power operation.

### LUGGAGE COMPARTMENT DOORS

To ensure that compartment doors have latched properly, press the bottom edge of the door with the palms of your hands. This is more important for smaller and lighter compartment doors because when the door is “dropped” closed, the air trapped inside the compartment may create a cushioning effect that could sometimes prevent door latches from engaging properly.

### POWER ELECTRIC MIRRORS

The electric mirrors are adjusted using a multi-directional switch located on the driver’s door.

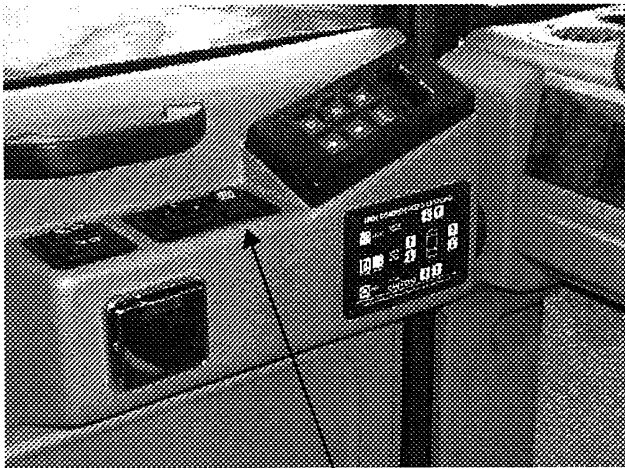

Power Mirror Controls

Select the mirror to be adjusted by pushing the switch in the middle of the control to the right or left. Then press the arrow buttons as necessary to obtain the best view.

When mirrors are adjusted to preference, place the selector switch back in the middle position to cancel power to the buttons. This prevents accidental misadjustment of mirror settings.

The mirrors also contain heating elements to defog or de-ice the mirror glass during cold weather operation. An ON-OFF switch for the mirror heaters is located near the remote mirror controls.

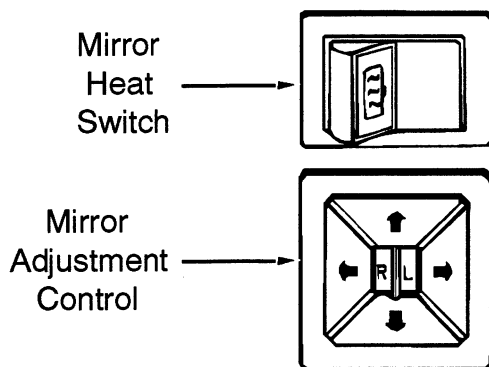

## SONY REARVIEW TV MONITOR SYSTEM

Refer to the Motor Home Operation Manual binder for specific instructions provided by Sony.

## SEATS

The driver and co-pilot seats may be independently adjusted to suit individual preference.

The seats may be swiveled to provide easy entrance and exit. The swivel feature also allows the seats on some models to be turned toward the living area for additional seating while the unit is parked.

### DRIVER SEAT

**To Swivel Seat:** Push swivel release paddle rearward. Paddle is located on lower right side of seat.

**To Recline Seats:** Push recliner release paddle rearward. Paddle is located on lower right side of seat.



Slide Control      Swivel Control      Lumbar Adjustment      Power Seat Controls

### Driver Seat

**WARNING**

Do not adjust driver's seat while vehicle is in motion.

After adjusting seat, always use body pressure to make sure slide and swivel locking mechanism have engaged.

**To adjust lumbar support (driver seat only):** The Lumbar Adjustment Switch is located on the right side of the driver seat. Press the forward side of the switch to increase support; press the rearward side to decrease support.

### 6-Way Power Seat Controls

The power seat controls are located on the lower right hand side of the seat base.

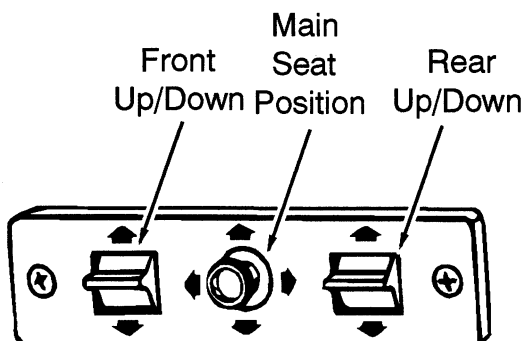

Power Seat Control

### PASSENGER "BUDDY" SEAT

**To Recline Seat:** Push recliner release paddle rearward. Paddle is located on lower left side of seat.

**To Slide Seat:** Push slider paddle rearward. Paddle is located on lower left side of seat.

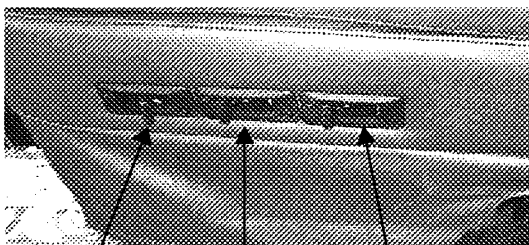

Swivel function  
inoperative on  
passenger seat

Push to  
Swivel

Push to  
Recline

Passenger Seat

### SEAT BELTS

Seats intended for occupancy while the vehicle is in motion are equipped with seat belts for the protection of the driver and passengers. The lap belts must be worn as low as possible and fit snugly across the hip area. Always sit erect and well back into the seat. To gain full protection of the safety belt, never let more than one person use the same safety belt at any one time, and do not

let the safety belts become damaged by pinching them in the doors or in the seat mechanism. After any serious accident, any seat belts which were in use at the time should be replaced.

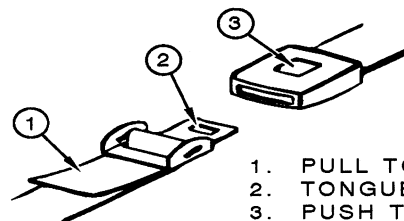

1. PULL TO TIGHTEN.
2. TONGUE.
3. PUSH TO RELEASE.

**Adjustment:** To lengthen belt, turn tongue at a right angle to belt and pull to desired length. To shorten, pull loose end of belt.

**To Fasten:** Be sure belt is not twisted. Grasp each part of the belt assembly and push tongue into buckle. Adjust to a snug fit by pulling the loose end away from the tongue.

**To Release:** Press button in center of buckle and slide tongue out of buckle.

#### WARNING

Snug and low belt positions are essential. This will ensure that the force exerted by the lap belt in a collision is spread over the strong hip area and not across the abdomen, which could result in serious injury.

Only seats equipped with seat belts are to be occupied while vehicle is in motion.

### THREE-POINT LAP-SHOULDER BELTS

The driver and co-pilot seat belts in your coach are equipped with automatic locking retractors that let you easily adjust your seat belt to the proper length for passenger safety.

#### Fastening:

- Grasp the belt just behind the tongue using the hand nearest the door or sidewall. Be sure the belt is not twisted before fastening.
- Pull the belt smoothly outward from the wall



and across your body, then insert the tongue into the buckle on the aisle side of the seat until it locks with a positive “click”.

*NOTE: Do not pull the belt away from the wall too quickly or it will “lock” and prevent you from pulling it any farther. If this happens, relax your pull on the belt slightly then continue pulling it less quickly.)*

- Feed any excess belt length back toward the wall so the belt retractor will lock the belt at the proper length for your body when released.
- The lap belt portion must be worn snug and low across the pelvic area.
- The shoulder strap portion must be worn diagonally across the chest and over the shoulder, but not against the neck.
- Seat belts offer optimum protection only when worn properly on the body and when the seat is in an upright position.

**Unfastening:**

- Press the release button in the buckle.
- Hold onto the tongue when you release it from the buckle to keep it from retracting too rapidly.

**WARNING**  
Never wear the shoulder belt in any position other than as stated above. Failure to do so could increase the chance or extent of injury in a collision

**CARE AND CLEANING**

- Be careful not to damage the belt webbing and hardware. Take care not to pinch them in the seat or doors.
- Inspect the belts and hardware periodically. Check for cuts, frays, and loose parts. Damaged parts should be replaced. Do not remove or modify the belt system.
- Keep belts clean and dry. If the belts need cleaning, use only a mild soap and water solution. Do not use hot water. Do not use

abrasive cleaners or bleach. These products may weaken or damage the belts.

- Replace any belt assembly that was used during a severe impact. Replace the complete assembly even if damage is not apparent.

**CHILD RESTRAINTS**

All 50 of the United States and the District of Columbia now require the use of the child/infant restraint systems for children in vehicles.

A properly installed and secured child restraint system can help reduce the chance or severity of personal injury to a child in an accident or during a sudden maneuver. Children may be injured in an accident if they are not seated in a child restraint which is not properly secured.

A child restraint system is designed to be secured in a vehicle seat by a lap belt or the lap belt portion of a lap-shoulder belt. According to accident statistics, children are also safer when properly restrained in rear seating positions than in front seating positions.

When purchasing a child restraint system:

1. Look for the label certifying that it meets all applicable U.S. Federal Motor Vehicle Safety Standards (FMVSS) or, in Canada, requirements of the Children's Car Seats and Harnesses Regulations (CCSHR).
2. Make sure that it will attach to your vehicle and restrain your child securely and conveniently so that you are able to install it correctly each time it is used.
3. Be certain that it is appropriate for the child's height, weight and development. The instructions and/or the regulation label attached to the restraint typically provides this information.
4. Review the instructions for installation and use of the restraint. Be sure that you understand them fully and can install the restraint properly and safely in your vehicle.



## INSTRUMENT PANEL

- |  |                                      |
|--|--------------------------------------|
| 1. Radio Speaker                       | 13. Rearview (Backup) Monitor        |
| 2. Wiper and Headlight Switches        | 14. Cigarette Lighter/12V Socket     |
| 3. Radio Power Switch                  | 15. Radio/Cassette Player/CD Control |
| 4. Aux. Start Switch                   | 16. Automotive Heater/AC Controls    |
| 5. Aux. Battery Switch                 | 17. Audio Selector Switch**          |
| 6. Instrument Panel*                   | 18. Air Brake Pressure Gauge*        |
| 7. Aux. Windshield Defrost Fans Switch | 19. Ignition Switch                  |
| 8. Rear Auto Heater Switch             | 20. Park Brake Knob*                 |
| 9. Fog Lamp Switch                     | 21. Headlight Switch                 |
| 10. Docking Lamps Switch               | 22. Exhaust Brake On/Off Switch*     |
| 11. Air Horn Compressor Switch         | 23. Side Window Defrost Duct         |
| 12. Aux. Generator Switch              |                                      |

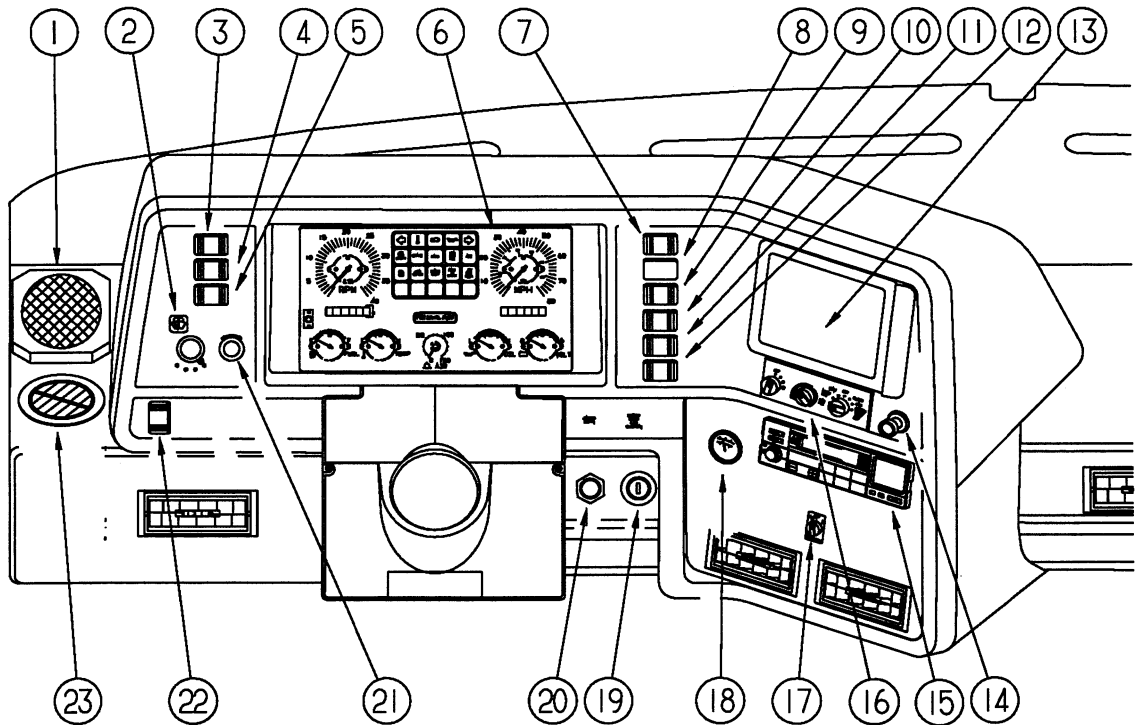

\* See your Freightliner chassis operator manual.

\*\*With Premium Sound System only.

NOTE: Some equipment or controls shown may be optional or unavailable on your model.

### MULTI-FUNCTION SIGNAL LEVER

The multi-function signal lever controls the turn signals, high/low beam changing, windshield washer, wipers and wiper delay, and the electronic speed control (cruise) on some models.

See your chassis operating guide for complete operating information.

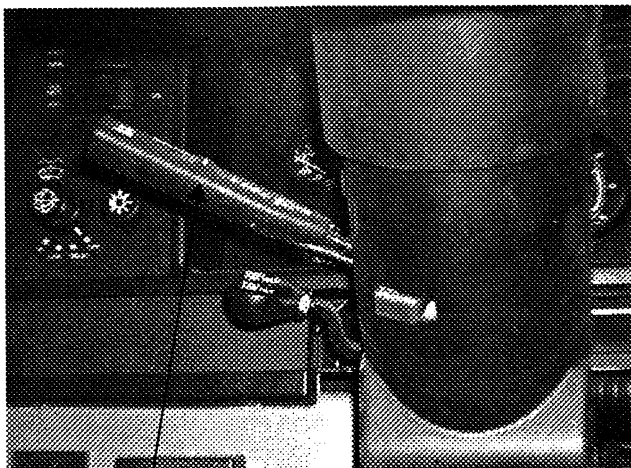

Multifunction Lever  
Signals/Hi-Lo Beams/Cruise

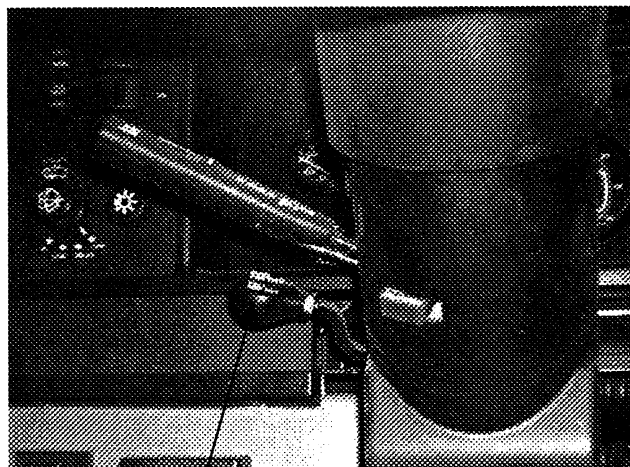

Pull to Tilt  
Push to Telescope

**To Adjust Telescoping Column:** Push the lever toward the dash. Push or pull the steering wheel to slide the steering column in or out to the desired length. Release the lever to lock the column into position.

### HEADLIGHT BEAM CHANGE AND TURN SIGNALS

Move multi-function lever upward for right turn signal and downward for left turn signal.

Pull end of handle toward you to switch high beam to low, or low beam to high.

### STEERING TILT/TELESCOPE

The tilt/telescoping adjustment lever is located on the left side of the steering column.

**To Adjust Tilt Wheel:** Pull the lever toward you and tilt the steering wheel to the desired angle, then release the lever.

#### WARNING

Do not adjust the steering column or tilt wheel while the vehicle is in motion. This could cause a loss of vehicle control.

### CRUISE CONTROL

The electronic speed control (cruise) allows you to maintain a steady speed and relieve driving strain while traveling long distances.

See your Freightliner chassis operator manual for complete instructions and precautions on the cruise control.

#### WARNING

Do not operate the cruise control on icy or extremely wet roads, winding roads, in heavy traffic, or in any other traffic situation where a constant speed cannot be maintained.

## WINDSHIELD WASH/WIPE SWITCH

**Wash:** Press the control knob to pump washer solution onto the windshield. The wiper will also begin operating. The wiper will continue for 5 wipes after you release the washer knob.

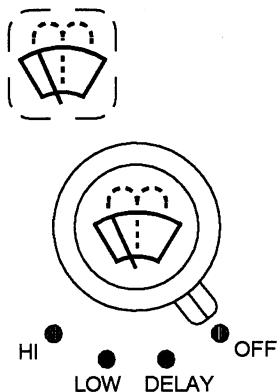

**Wiper:** Rotate the outer knob pointer to the desired setting - Delay, Low or Hi.

**Delay:** Turn the outer knob pointer to "DELAY". Turn the center (wash) knob to set the time you want between wipes, from 1 second (all the way left) to about 90 seconds (all the way right).

## COMFORT CONTROLS

### AUTO AIR CONDITIONER/HEATER

Controls for the air conditioner, heater, defroster and vent are all combined into one control panel. Refer to the following instructions for use of individual controls.

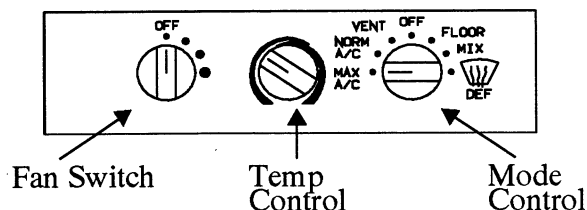

1. Front Heater Fan Switch
2. Temperature Control Knob
3. Mode Selection Knob

### HEATING

A. For maximum heating

1. Turn the mode selection knob HEAT or VENT.
2. Turn the temperature control knob to WARM (red).
3. Place the fan switch to high (largest dot).

B. For reduced heating:

1. Turn the temperature control knob to the left to an intermediate setting.
2. Adjust the fan speed for desired volume.

### DEFROSTING

A. For maximum defrosting and defogging:

1. Press the DEF button.
2. Turn the temperature control knob to WARM (red).
3. Turn the fan switch to high (largest dot).
4. Turn on auxiliary (dash) fans if additional air movement is needed

B. For reduced defrosting:

1. Turn the temperature control knob to the left to an intermediate setting.
2. Adjust the fan speed for desired volume.

### VENTILATION

A. To vent outside air into the vehicle when neither heating or cooling is required.

1. Turn the mode selection knob to vent.
2. Turn the temperature control knob all the way to the left to the COOL (blue).
3. Adjust the fan speed for desired volume.

### AIR CONDITIONING

A. For maximum cooling.

1. Turn the mode selection knob to MAX A/C.
2. Turn the temperature control knob all the way left to the COOL (blue) position.
3. Turn the fan speed switch in to high (largest dot).

### OFF

When no heating, cooling or defrosting are required:

1. Turn the mode selection knob to OFF. This will shut off the fan and prevent outside air from entering the unit.

*NOTE: The automotive air conditioner is not designed to cool the entire interior of the motor home, but is intended to cool the driver's compartment only.*

⚙️ **ENERGY TIP:** Turn off any electrical items or accessories (lights, fans, defoggers, etc.) when not being used. This reduces fuel consumption by cutting down electrical load on the automotive alternator. The more electrical items being used, the greater the electrical "pull" on the alternator, which causes the engine to work harder and use more fuel.

### RADIO SWITCH

The radio switch allows you to connect the auto radio to the coach batteries for operation while parked, with the ignition switch off. This prevents accidental draining of the automotive (starting) battery by the radio.

### SONY AUDIO SYSTEM - Optional

Your coach is equipped with one of three models of high quality audio systems, combining AM/FM radio sound with either a cassette or CD player. This system provides you with high quality stereo sound for your traveling and living enjoyment. Refer to the Radio Manufacturers Operating Guide in your Motor Home Operation Manual for operating and care instructions.

### COMPACT DISC CHANGER - Optional

The remote CD changer is located out of sight in the overhead cabinet above the driver's seat. The changer cartridge holds up to 10 compact discs for over 7 hours of listening enjoyment.

The controls are incorporated into the dash radio. See the Sony Compact Disc Changer System operating guide in your motor home operations manual binder for complete operating instructions and basic troubleshooting.

### PREMIUM SOUND SYSTEM - Optional

Your coach may be optionally equipped with the premium sound system. Featuring a high quality AM/FM Stereo radio and a 10-disk DC changer for hours of listening enjoyment. The powerful 40-watt amplifier with 9-band graphic

equalization provides distortion free listening through four BOSE® ACCOUSTIMASS® SERIES III cube speakers and two bass enhancement sub-woofer modules.

### To Listen Through Dash Radio:

Place the Audio Selector Switch (on the dash) in RADIO mode.



Audio Selector Switch on dash

### To Listen to Stereo TV or VCR:

Place the Audio Selector Switch (on the dash) in TV or VCR mode.

*Note: Place the Audio Selector Switch in OFF or RADIO mode when not viewing the TV to prevent the amplifier from draining 12-volt batteries.*

*The dash radio speakers may still be used while the TV is feeding through the BOSE system in case the driver wishes to listen to the radio while a passenger is watching the TV or VCR.*

### AUX. START SWITCH

This switch can be used to provide emergency starting power from the motor home auxiliary battery if the automotive battery is discharged.

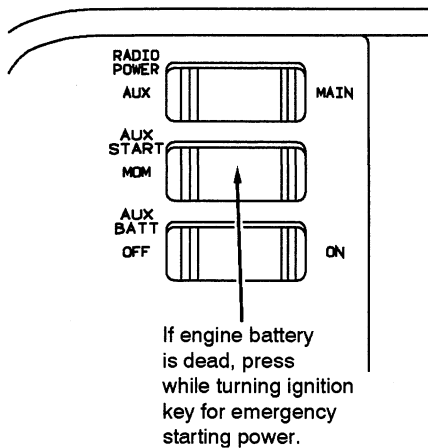

### AUXILIARY BATTERY (Aux. Batt) SWITCH

The AUX BATT switch disconnects the auxiliary (coach) batteries from the 12-volt system of your coach to avoid long-term battery drain by electrical items that are hooked directly to the coach batteries.

Always leave this switch ON except during long storage periods (a month or more).

### CB RADIO WIRING (Optional)

Your coach is pre-wired for CB radio installation. The wires are located beneath the dash to the left of the steering wheel.

Look for a pair of wires, red and black, with connectors and flag labels, suspended from the wiring harness.

Be sure to read the wire labels before installing a CB radio. The labels contain important information and cautions.

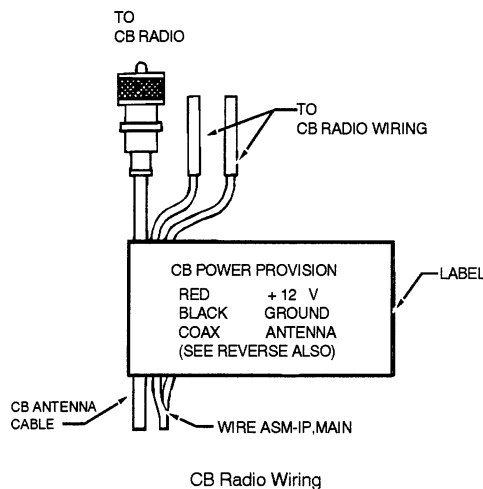

### SWR ADJUSTMENT

To adjust CB antenna SWR (standing wave ratio), remove the cap on the end of the antenna. Turn the adjusting screw inside end of antenna to achieve lowest SWR reading. This procedure will help optimize transmitting and receiving capabilities of the radio system.

**CAUTION**

The CB radio could become damaged if CB antenna SWR is not adjusted before operating CB radio.

### AUTOMATIC COACH LEVELING SYSTEMS

Your coach is equipped with a 4-point HWH computerized, automatic, hydraulic leveling system.

This leveling system is designed to diminish problems in selecting a parking site, making “set up” easier and faster for you.

See the HWH Operator Manual in your Motor Home Operations Manual binder for complete operating instructions. It also contains additional precautions, technical information, and instructions for manual operation if automatic functions fail.

The leveling system control panel is located on the driver’s door panel.

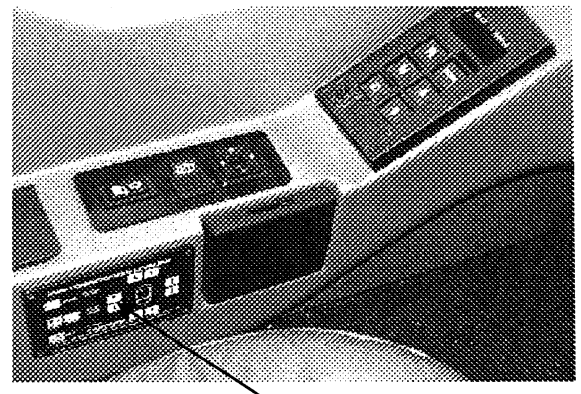

Automatic Leveling System  
Control Panel

*NOTE: When parking at an uneven site, always park the front of the motor home to the downhill side. This allows you to level by*

*raising the front end rather than the rear. Since only the rear wheels are locked while in PARK, raising the rear wheels off the ground could allow the vehicle to roll off the jacks.*

**CAUTION**

Do not try to drive vehicle unless 'TRAVEL' light is glowing with ignition switch on.

Do not try to drive the vehicle until the air suspension system has built up sufficient pressure if you have used the coach leveling system or have used the DUMP button to manually exhaust the air suspension system.

**WARNING**

Keep all people clear of the coach while the leveling system is operating.

Do not use leveling jacks to support vehicle for service or tire changing.

### HAZARD WARNING FLASHER

The hazard warning flasher provides additional safety when the vehicle must be stopped on the side of the roadway and presents a possible hazard to other motorists. When the flasher is on, it serves as a warning to the other drivers to approach and overtake your vehicle with caution.

**WARNING**  
Operating the hazard warning flasher system while moving on the highway is illegal.

The front and rear turn signals will flash intermittently when the flashers are in operation. When it is necessary to leave the vehicle, the flasher system will continue to operate with the ignition key removed.

See page 2-3 for information on operating the hazard warning flashers.

### IF YOU GET A FLAT TIRE

In case of sudden tire failure, avoid heavy brake application. Gradually decrease speed. Hold steering wheel firmly and move slowly to a safe, off-road place. Park on a level spot, set the parking brake, turn off the ignition, and turn on the hazard warning flasher system.

### Motor Home Tire Changing

This vehicle is not equipped with a spare tire. If you have a tire related road emergency we recommend obtaining a qualified tire road service center, which has the necessary equipment and expertise to handle road tire emergencies quickly and safely.

Instructions on jacking and tire changing can be found in your Freightliner chassis operator manual and may be used for reference by road service personnel.

### RECOVERY TOWING

When calling a professional towing service, we recommend that you advise them of your

coach length and approximate front axle weight. This will allow the towing operator to determine the proper towing equipment to use. (This information is found on the vehicle certification label located to the left of the steering wheel.)

We recommend that you ask for an underlift (wheel lift or frame lift) type towing assembly for safe towing.

Winnebago Industries does not assume responsibility for damage incurred while towing this vehicle.

*NOTE: Consult the Freightliner chassis operating guide for any additional towing instructions or precautions provided by the chassis manufacturer.*

**CAUTION**  
Do not lift on bumper. Damage will result to front end body parts.

**WARNING**  
Stay out from beneath the motor home while it is suspended by the towing assembly unless the vehicle is adequately supported by safety stands. Do not allow passengers to occupy a towed vehicle.

*NOTE: Know and obey all state and local towing regulations. Tow at reduced speed.*

### JUMP STARTING

If your coach will not start from the automotive batteries, try using the aux. start switch to divert power from the coach batteries to the start. (See Aux. Start Switch on page 2-14.) If you wish to try jump starting the engine using another vehicle or booster system, here are basic guidelines for connecting jumper cables to automotive electrical systems.

**WARNING**

Automotive batteries produce caustic acid, explosive gases, and electrical current which may cause burns. It is important that the instructions below are followed **exactly**, or personal injury (particularly to eyes) or property damage may result due to battery explosion, battery acid, or electrical (short circuit) burns.

- NEVER smoke near the battery or expose it to open flame or electrical sparks.
- Wear eye protection or shield your eyes while working near battery, in case an explosion does occur. NEVER lean over a battery.
- Do not allow battery fluid to contact eyes, skin, clothing, or painted surfaces. Immediately flush any contacted area with water. If eyes are affected, seek medical help after flushing.
- Remove all metal jewelry to lessen the risk of a short circuit occurring.

**CONNECTING JUMPER CABLES**

1. Make sure that the other vehicle has a 12-volt battery and negative ground compatible with your vehicle's electrical system.
2. Position the vehicle with the good battery so that the jumper cables will reach, but **do not allow the vehicles to touch**.
3. Turn off all electrical accessories, motors, and lights except those needed for safety or to light up the work area. Place automatic transmission in N (Neutral) and apply parking brake. Be sure parking brakes are engaged in both vehicles.
4. If the weak battery has filler caps, make sure the electrolyte is at proper level. Add distilled water if fluid is low. If electrolyte is not visible or appears to be frozen - **do not**

**attempt jump starting!** A battery may rupture or explode if the electrolyte is frozen or not filled to the proper level.

5. Connect one end of the positive "+" (red) jumper cable to the positive "+" terminal of the weak battery. Connect the other end to the positive "+" terminal of the charged battery.
6. Connect one end of the negative "-" (black) jumper cable to the negative "-" terminal of the charged battery.
7. Finally, connect the remaining end of the negative "-" (black) cable to a solid, metal grounded location on the engine of the vehicle with the weak battery, at a point at least 18 inches from the battery. Do not connect to any moving parts. **THE MAIN SAFETY PRECAUTION IS TO MAKE THE FINAL GROUND CONNECTION ON THE ENGINE AT A SAFE DISTANCE FROM THE BATTERY. THIS HELPS TO REDUCE THE CHANCE OF EXPLOSION DUE TO SPARKS.**
8. Start the engine of the vehicle with the charged battery, and allow it to run for a few minutes at moderate r.p.m. Then start the engine of the vehicle with the discharged battery.
9. Reverse the above sequence **EXACTLY** when removing the jumper cables. Start by removing the cable from the ground location on the engine first, then continue in reverse sequence.

**WARNING**

Do not attempt to push-start this vehicle. Damage to the transmission or other parts of the vehicle could occur.

**CONNECTING A BATTERY CHARGER**

To connect a battery charger, first make sure the engine is switched off. Disconnect the negative lead from the battery. Never disconnect the battery while the engine is running or alternator damage could result.

Connect the positive "+" (red) lead of the charger to the positive "+" terminal on the bat-



tery. Next, connect the negative “-” (black) lead of the charger to a suitable ground. Finally, plug in or switch on the charger.

To disconnect the charger after charging, unplug the charger from the electrical outlets, remove the charger leads from the vehicle, and reconnect the vehicle leads to the battery.

### ENGINE OVERHEAT

If you see or hear steam escaping from the radiator or the engine compartment or have any other reason to suspect an extreme engine overheating condition, pull the vehicle over to the roadside as soon as it is safe to do so, stop the engine and get out of the vehicle.

#### **WARNING**

Operating a vehicle under a severe overheating condition can result in damage to the vehicle and may result in personal injury.

An engine will overheat if the water pump drive belt breaks, if the coolant is low or there is a loss of coolant because of one or more of the following:

- a leak in the cooling system
- a hose failure
- water pump failure

Also, be aware of the following situations, which can cause temporary engine overheating:

- climbing a long hill on a hot day
- idling while stopped in traffic for long periods of time
- towing a trailer or automobile
- stopping after a period of high speed driving

If the TEMP indicator on the instrument panel shows a rise in engine coolant temperature while driving, take the following steps to try to lower the overheating:

- If you are using the automotive air conditioner, turn it off.
- If you are stopped in traffic, shift the transmission into N (Neutral), and engage parking brake.

If the temperature does not drop within a minute or two:

- Pull the vehicle over to the roadside as soon as it is safe to do so.
- Place the transmission in N (Neutral) and press the accelerator to increase engine speed (r.p.m.'s) to twice that of normal idle speed, and hold it there for approximately two or three minutes.
- If engine temperature does not go down, turn the engine off and wait until the engine has cooled before opening the engine compartment

When no trace of escaping steam is heard or seen, open the hood to check for the cause of the overheat. Check hose connections and tighten if necessary. Make sure there are no broken belts, pulleys or hoses before adding any coolant to the coolant reservoir.

For further information about overheating, consult your Freightliner chassis operating guide.



(See also SAFETY PRECAUTIONS, Section 1 of this manual.)

#### LOADING THE VEHICLE

When loading the vehicle, distribute the cargo load equally so that you do not exceed either the Front or Rear Gross Axle Weight Rating (GAWR) or the Gross Vehicle Weight Rating (GVWR). The Gross Axle Weight Rating (GAWR) means the weight value specified by the chassis manufacturer as the load carrying capacity of a single axle system as measured at the tire-to-ground interfaces. This is the total weight a given axle is capable of carrying. Each axle has its own rating.

Have your vehicle weighed to determine the proper load distribution for your vehicle. Also distribute cargo side-to-side so the weight on each tire or dual set does not exceed one half of the GAWR for either axle.

For example, if the Front GAWR is 6,000 lbs., there should be no more than 3,000 lbs. on each tire. (If the left side weighs 3,100 lbs. and the right side weighs 2,700 lbs., at least 100 lbs. of the load should be shifted from the left side to the right side.) The GVWR is listed on the Vehicle Certification Label. (See page 0-3).

The total combined weight allowed for the vehicle, including trailer towing load weight, is known as the Gross Combined Weight Rating (GCWR). If trailer towing is not recommended, the GCWR will equal the GVWR.

*NOTE: We recommend that you dump all holding tanks before traveling to avoid carrying unnecessary weight.*

#### CAUTION

The weight of the loaded vehicle (including options, attachments, passengers, water, fuel, luggage and all other cargo) must not exceed the GVWR or GAWR of either axle.

#### FRONT AXLE TIRE ALIGNMENT

We recommend that you have the front suspension and steering alignment checked and adjusted after you have fully loaded the vehicle according to your needs. Thereafter, have alignment inspected periodically to maintain vehicle steering performance and prevent uneven tire wear.

#### WEIGHING YOUR LOADED VEHICLE

To check the weight of your fully loaded coach, locate a commercial weighing scale that is capable of weighing large trucks.

Drive the entire coach onto the scale. This weight should not exceed the Gross Vehicle Weight Rating (GVWR) specified on the Vehicle Certification Label near the driver seat. (See sample on page 0-3.)



GVWR (Both Axles)



Front GAWR  
(Front Axle Only)



Rear GAWR  
(Rear Axle Only)

To determine the weight on either front or rear axle, drive that axle only onto the scale. Neither axle weight should exceed the corresponding maximum axle weight rating specified on the certification label.

#### MAXIMUM OCCUPANCY

The following label is placed in a visible location in the driver compartment.

**BELTED SEATING POSITIONS MAY EXCEED SLEEPING CAPACITY OF THIS VEHICLE. SEE OWNER MANUAL FOR OCCUPANCY AND WEIGHT RESTRICTIONS.**

## SECTION 4

# TRAVELING WITH YOUR MOTOR HOME

# L U X O R

The number of belted seating positions in your motor home may exceed the number people used to determine maximum coach occupancy, called the Net Carrying Capacity (NCC) in the U.S. or Cargo Carrying Capacity (CCC) in Canada.

To calculate the NCC or CCC, Winnebago uses vehicle sleeping capacity, however your coach may be equipped with more belted seating positions than sleeping positions to give passengers a choice of seating arrangements. You may use all of the belted seating positions providing you stay within your vehicle's GVWR listed on the Vehicle Certification Label (see page 0-3). However you use or load your vehicle, it is your responsibility to keep the weight within its stated gross vehicle weight rating.

## ROOF LOADING

The roof is capable of carrying some light-weight articles while the vehicle is in motion. A roof-mounted luggage carrier designed for this purpose is available from your dealer. However, roof load while the vehicle is in motion is not to exceed 10 pounds per square foot or a maximum of 100 pounds.

When the vehicle is stationary, a cargo load of 100 pounds plus the weight of a 225 pound person to load the cargo or to conduct inspection and maintenance is permissible.

Weight added to both the roof and the trailer hitch contribute to the gross vehicle weight, which must not exceed the vehicle's GVWR.

## TRAILER TOWING

The factory installed towing hitch on this coach is capable of pulling 3,500 lbs. (max.) and carrying 350 lbs. (max.) on the hitch ball. However, your coach's towing and hitch ball capacity may be less due to the coach's loaded weight and/or the towed vehicle's weight and hitch ball weight. The combined weight of the coach and the towed vehicle should not exceed the coach's Gross Combined Weight Rating (GCWR). Also, the combined weight of the coach and the towed vehicle's hitch ball weight should not exceed the coach's Gross Vehicle Weight Rating (GVWR) or its rear Gross Axle Weight Rating (GAWR) listed on the Vehicle Certification.

Because of individual vehicle use and loading habits, we recommend weighing the vehicle while fully loaded to avoid exceeding any of the listed Gross Weight Ratings. See "Vehicle Certification Label" on page 0-3 for information on gross weight ratings.

Towing will affect vehicle handling, durability and fuel economy. Exceeding any of the listed Gross Weight Ratings will result in unacceptable overall vehicle performance. Maximum safety and satisfaction when towing depends on proper use of correct equipment. A hitch bar of appropriate steel and size should be selected to mate with the Winnebago towing receptor.

Installation of a proper trailer brake system is recommended. Check state regulations on trailer weight and trailer brake requirements to be sure you select the right equipment before towing.

Before descending a steep or long grade when towing a trailer, reduce speed and shift into a lower gear to control vehicle speed. Avoid prolonged or frequent application of brakes which could cause overheating and brake failure.

### WARNING

For safety towing and vehicle handling, maintain proper trailer weight distribution.

The total weight of the motor home and the vehicle towed must not exceed the Gross Combined Vehicle Weight rating. Contact the chassis manufacturer to obtain the Gross Combined Vehicle Weight rating for your chassis.

### CAUTION

Exceeding any of the recommended gross vehicle weight ratings may result in vehicle damage.

Do not install a frame equalizing type hitch on your vehicle.

See also - Trailer wiring connector, page 6-10.

#### PRE-TRAVEL CHECK LIST

Before starting the engine to leave on a trip, be sure your motor home has been properly prepared and maintained. This will ensure an enjoyable trip and help avoid delays. Use this checklist as a guide.

- Fluid Levels - Check and fill if necessary:
  - engine oil
  - transmission
  - power steering
  - radiator
  - brake
  - battery
  - windshield washer
- Wheel Lug Nuts - Check for tightness
- Tires - Check for proper cold inflation pressures as specified on the Vehicle Certification Label.
- Drive Belts - Check for proper condition and tension (not cracked, frayed, or loose, etc.)
- 110-Volt Generator (Optional) - Check oil level in generator engine.

#### WARNING

Never check oil level in generator while engine is operating.

- Fire Extinguisher - Make sure it is fully charged and secured in mounting bracket.
- Lights - Make sure all exterior lights operate.
- Sewer and Water Supply Hose - Unhook and store.
- TV Antenna - Make certain the TV antenna is lowered and seated in its support cradle.
- Loose Items Inside the Motor Home - Store or secure items.
- Pilot Lights - Make sure all pilots are off.
- Fuel Tanks - Check level.
- Water Tank - Fill with fresh water.
- Exterior Door and Step - Make sure doors are closed, locked and step retracted.
- Seats - Adjusted for comfortable position and locked in place.
- Mirrors - Adjust for maximum visibility from driver's seat.

#### EQUIPPING FOR TRAVEL

When beginning a trip, several items should be taken in addition to the basic clothes, food and recreational items. A checklist is provided for

your convenience. Remember, it is important to distribute weight and store all heavy items near the floor.

#### EMERGENCY EQUIPMENT CHECKLIST

- Flashlight
- First Aid Kit
- Road Emergency Flares
- Tool Box with Assortment of Hand Tools
- Plastic Bucket
- Tow Chain or Rope
- Wheel Blocks or Extra Jacks for leveling
- Water Hose
- 100-150 Feet of 3-Wire Electrical Cord with at least 30 AMP Capacity
- Fire Extinguisher
- Hydraulic Jack and Lug Wrench
- Spare Tire

#### QUICK LOADING CHECKLIST

##### BEDDING

- Sleeping Bags
- Sheets
- Pillow Cases and Pillows
- Mattress Pads
- Extra Blankets
- Laundry Bags

##### COOKING

- Can Opener
- Bottle Opener
- Aluminum Foil
- Matches
- Plastic Bags
- Coffee Pot
- Storage Dishes

##### CLEANING

- Scouring Pads
- Cleanser
- Glass Cleaner
- Dish Soap
- Sponge
- Laundry Soap
- Cleaning Rags or Paper Towels
- Garbage Bags

##### BATHROOM

- Bath/Hand Soap
- Bath Towels that can double as Beach Towels

## SECTION 4

### TRAVELING WITH YOUR MOTOR HOME

# L U X O R

- Toiletry Kits
- Toothbrushes and Toothpaste
- Shaver/Razors
- Toilet Tissue (RV)

#### BABY NEEDS

- Car Seat (Child Restraint)
- Portable Crib
- Play Pen

#### PERSONAL

- Credit Card(s)
- Traveler's Checks
- Money
- Driver's License
- Proof of Citizenship (for Canadian or Mexican crossing)
- Sunglasses

#### PET NEEDS

- Food
- Leash
- Water and Food Dishes
- Proof of Rabies Shot

#### MISCELLANEOUS

- String
- Clothesline
- Insect Repellent
- Masking Tape

### TRAVEL TIPS

As you travel around the country in your motor home, you will pick up useful advice from other motor home owners.

A number of suggestions can also be obtained by reading articles and regular columns in outdoor and camping magazines. Some magazines and publishing companies print an annual park and campground directory. These can be found at your local news stand or RV supply dealer. Here are a few travel tips to begin with.

1. Always check for sufficient clearance. Know the height and width of your unit.
2. Always fill the fresh water tank at an approved potable water filling facility or a known purified drinking water source. Taste the water before filling the water tank in an unfamiliar location. The water in some areas

may contain an undesirable taste. Do not use a new hose to fill the water tank. It can leave a distinct rubber or vinyl taste.

3. Showers can take a lot of water. Conserve water by taking a "Sea Shower". This is done by wetting down, turning off the water, soaping thoroughly and then rinsing.
4. Dump sewage only at approved dumping stations.
5. Store liquids in plastic containers with tight fitting caps to prevent spills.
6. Keep an eye on the water and holding tank levels. It is a good idea to dump the holding tank at least every two days.
7. When traveling with children, it is helpful to plan their wardrobe for a week. Place each days clothing in a plastic bag and label the bag with the child's name and day of the week for use.
8. Use sleeping bags whenever possible. They save laundry and take up less storage space than bedding.
9. Make sure all compartment doors have been closed and the door step has been stowed in the correct position before moving the vehicle.
10. Before traveling, make sure the refrigerator door has been secured. Use care when opening the refrigerator door after the vehicle has been stopped. Any articles that have shifted may fall out when the door is opened.
11. During peak tourist season and holidays, it is best to phone ahead and make reservations at the park where you plan to stop.
12. Some states or cities will not permit vehicles with LP gas containers to pass through highway tunnels. If your route includes a tunnel, check with the highway patrol or department of highways to avoid inconvenience.
13. Do not leave food or odor-causing material in your vehicle for extensive periods of time. Always allow damp clothing, swimwear, hunting gear, etc., to dry before stowing.
14. Become familiar with the fire extinguisher and make sure it is always fully charged. Remove and replace it and read instructions so you know the correct operating procedure before an emergency happens
15. Make a list of all groceries, fresh meats, vegetables, newspapers, etc., that you may need and try to pick them up during your last fuel stop of the day. This will prevent leaving a

good parking spot once you have arrived at your destination.

16. When you sit over the front wheels while driving, as in a motor home, you have a tendency to crowd the middle of the road. Check the side view mirror frequently to observe how close you are driving to the center line.

#### SEVERE WEATHER INFORMATION

One of the more serious conditions affecting the motor home traveler and camper is that of the weather. Whether you travel the high mountain terrain, the lower deserts and flatland or the plains of the midwest, the weather is always with you and subject to change, sometimes with little or no warning. However, adequate warnings are normally broadcast over local radio and TV stations.

Motor home travelers and campers often seek secluded areas for weekend recreation or extended summer vacations. Many recreational areas are vulnerable to severe weather situations, especially flash flooding conditions. A few simple precautions may help lessen the hazards of flash flooding or reduce your immediate involvement.

*NOTE: We recommend that all motor home occupants become familiar with these safety precautions, and be alert to change in weather.*

- Be alert, because thunderstorms can form at any time, in any month of the year. Thunderstorms can produce large amounts of rain over a small area in a short time, which may result in a flash flood. Listen frequently to weather reports on the radio for weather and flood conditions.
- When camping near a stream, leave plenty of sloping bank between you and the stream.
- Avoid deep canyons and dry washes during stormy or threatening weather. Be aware of alternate exits.
- If heavy rain occurs, move to high ground immediately (at least 30-40 feet above the canyon floor or bottom of dry wash).
- During a flash flood, if you cannot move your

vehicle, abandon it. Do not attempt to return to your vehicle before the water has receded.

- Do not attempt to wade to your vehicle if the water is above your knees - fast moving water exerts an enormous amount of pressure, making it impossible to remain standing or walking.
- Do not try to drive through flooded areas.
- Follow instructions of local authorities. Leave immediately when advised to do so. Many lives have been lost because people did not heed warnings.
- Have on hand survival supplies for several days, including food, water, first aid equipment and necessary medications. In desert areas during hot weather allow 3-4 gallons of drinking water per person, per day.
- Before you leave home, inform someone of your destination and when you expect to return. Authorities at your destination should be notified immediately if you do not arrive on time.

#### REMEMBER THESE TERMS:

**WATCH:** Severe weather may develop in the specified area. Be alert and prepare for possibility of an emergency.

**WARNING:** Severe weather is occurring or is imminent in certain areas. Move to a safe location immediately.

We highly recommend that you obtain a weather radio. These radios offer up-to-date weather reports. The latest information and forecasts are broadcast by local National Weather Service offices in recorded messages that last from three to five minutes. These messages are replayed continually 24 hours a day. The recorded messages are revised every three to four hours, or more frequently when appropriate.

When severe weather threatens, forecasters at the local National Weather Service office interrupt the broadcasts with storm warnings, either recorded or "live" as the situation demands.

## SECTION 4

# TRAVELING WITH YOUR MOTOR HOME

# L U X O R

The frequencies used for NOAA Weather Radio (National Oceanic and Atmospheric Administration) nationwide are 162.40, 162.475 or 162.55 megahertz.

## NIGHTTIME DRIVING

- Make sure all running lights and signal lights are clean and in working order. Have your headlights periodically checked and adjusted.
- Use care when passing other vehicles. Your motor home is a longer vehicle than a car, and you may have a more difficult time knowing when to pull back into your lane. If possible, have another person in the coach help you watch while maneuvering your motor home in traffic.

## MOUNTAIN DRIVING

Special techniques must be used when driving in mountainous or hilly country.

## CLIMBING A HILL

The transmission will automatically downshift as needed to climb most hills. If the hill is long or very steep, however, you may need to manually shift to a lower gear to keep the transmission from repeatedly upshifting and downshifting. Select the lowest adequate gear range for the duration of the incline. See the Allison transmission manual in your Operations Manual binder for specific instructions.

### CAUTION

Observe the engine temperature gauge more frequently than normal. If overheating occurs, pull off to the side of the road and allow the engine to thoroughly cool before refilling the radiator and restarting the engine.

## DESCENDING A HILL

When going down a long grade, you may need to manually shift to a lower gear, rather than keeping your foot on the brake pedal. A lower gear will allow the engine to provide a degree of braking action. Holding your foot on the brake pedal for an extended period may cause brakes to overheat, causing you to lose control of the vehi-

cle. See your chassis operating guide for more information. See also Jacobs Extarder Exhaust Braking System on page 2-3 or the Jacobs Extarder user guide for exhaust braking information.

### CAUTION

Observe the engine temperature gauge more frequently than normal. If overheating occurs, pull off to the side of the road and allow the engine to cool thoroughly before restarting the engine.

## CAMPSITE SELECTION

Try to pick as level a spot as possible on which to park your motor home. Whether you nose into a parking site or back into it depends on personal preference and the location of the site's utility hook-ups. Remember that the utility connections on your motor home are on the left (driver) side of the vehicle.

## LEVELING

(See "Coach Leveling Systems" on page 2-15).

Leveling the motor home is very important, not only for your comfort but for appliances and plumbing as well. Some refrigerators are extremely sensitive to being unlevel. The ammonia vapor cooling system used in most RV refrigerators can "lock-up" and damage the refrigerator if it is not level. This is both inconvenient and costly. Also, water and holding tank level indicators may give false readings because water level is greater at one side of the tank than the other.

The refrigerator is installed level at the factory. So, if the refrigerator is level, the motor home is level. A small bubble-level sight is included in the refrigerator to help you determine refrigerator leveling.

*NOTE: We do not recommend lifting any of the wheels off the ground for leveling. This could allow the coach to roll off the jacks, possibly resulting in damage to the vehicle.*



#### **Hydraulic Leveling System - Optional**

See *Coach Leveling Systems* on page 2-15 for operating information.

#### **EFFECTS OF PROLONGED OCCUPANCY**

Your motor home was designed primarily for recreational use and short term occupancy. If you expect to occupy your coach for an extended period, be prepared to deal with condensation and humid conditions that may be encountered.

*NOTE: Your coach is not designed or intended to be used as permanent housing. Using this product for long term occupancy or permanent housing may lead to premature deterioration of structure, interior finishes, fabrics, carpeting and drapes. Damage or deterioration due to long term occupancy may not be considered normal and, under the terms of the warranty, may constitute misuse, abuse, or neglect, and may therefore reduce your warranty protection.*

#### **HUMIDITY AND CONDENSATION**

Moisture condensing on the inside of windows is a visible indication that there is too much humidity inside the coach. Excessive moisture can cause water stains or mildew which can damage interior items such as upholstery and cabinets. When you recognize the signs of excessive moisture and condensation in your coach, you should take immediate action to minimize their affects. You can help reduce excessive moisture inside the motor home by taking the following steps:

**Ventilate with outside air:** Partially open one or more windows and a roof vent to circulate outside air through the coach. In cold weather, this ventilation may increase operation of the furnace, but will greatly reduce condensation inside the coach.

**Minimize moisture released inside the coach:** Run the range hood fan while cooking, and open a bath vent while bathing or showering to carry

water vapor out of the coach. Avoid making steam from boiling water excessively or letting hot water run. Avoid bringing extra moisture into the coach by way of soaked clothing or snow on shoes. Do not hang-dry wet overcoats or clothing inside the coach.



(See also Safety Precautions, Section 1 of this manual.)

### LP GAS SUPPLY

The LP gas system supplies fuel for the range, water heater, furnace and refrigerator (while in gas mode). When used and handled properly, this system is safe and economical and provides modern living conveniences wherever you travel.

### SAFE USE OF THE LP GAS SYSTEM

The LP system is designed and built with strict adherence to both federal and recreational vehicle industry requirements for mobile LP gas equipment.

For your safety, there are many safety devices and backup systems installed, such as tank fill overflow valves, an interior LP gas detector/ alarm, and an interior carbon monoxide (CO) detector/alarm.

LP gas also contains an odor additive that you can smell if LP is present in the air.

Listed below are a few precautions to observe that will help you to use the LP gas system safely.

- Exercise caution at all times. Be familiar with the distinctive odor of LP gas. If a leak is suspected, turn off the supply valve immediately. Have the LP gas system checked by your dealer or a qualified LP gas service center.
- Do not tamper with the LP gas piping system, pressure regulator or gas appliances. Service and maintenance of LP gas system components should be performed only by your dealer or a qualified LP gas service center.
- Never attempt to connect natural gas to the LP gas system.
- Have the entire LP gas system inspected for possible leaks and missing or damaged parts at each tank filling. Also inspect before and after each trip, and any time trouble is suspected.

- Turn the LP supply valve off when not using the LP gas system.
- Never use a wrench to tighten the tank supply valve. It is designed to close leak-tight by hand. If a wrench is required to completely close the valve, it is defective and must be replaced.
- Never allow the tank to be filled above the 80 percent level indicated by the flow of liquid gas out of the overflow valve or by the automatic stop-fill device.
- Be sure appliance and outside vents are open and free from obstruction when using the LP gas system.
- Never attach a lock or any device requiring a key to the LP tank compartment door. According to standards set for recreation vehicles, the LP supply valve must be readily accessible in an emergency.
- Exercise caution when drilling holes or attaching objects to the walls. Gas lines and electrical wiring could be seriously damaged and present an extreme safety hazard.

### HOW LP GAS WORKS

LP (Liquified Petroleum) gas is a true gas compressed into liquid form for easy transportation and storage. LP gas is available in two types - propane and butane. It is also called tank gas, bottle gas, or simply LP.

LP is used by appliances in vapor form only, but is stored in the tank as a liquid under very high pressure. As the liquid gas is released, it reverts back to a vapor and expands to many times its compressed volume.

### SELECTING FUEL TYPES

Butane burns hotter than propane, but will not develop a usable gas vapor at temperatures lower than 32° F. Propane, on the other hand, does not burn as hot but will convert to usable gas at temperatures down to -44° F. For this reason, pro-

## SECTION 5 LP GAS SYSTEM

# L U X O R

pane is popular in cold climates, while butane and propane/butane mixtures are used most widely in milder climates.

*NOTE: Most LP dealers normally handle only the type of LP gas commonly used in their climate and area. If you anticipate filling your tank in one of the warmer states prior to traveling to a colder area, it is advisable to request propane only. Otherwise your LP system may fail to operate if the temperature drops below 32° F.*

### LP GAS OUTPUT

Each gallon of liquid LP gas contains approximately 92,000 BTU's of heat energy; or about 36.2 cubic feet of dry gas for cooking, heating, water heating and refrigeration.

LP gas tank capacities are often listed in pounds rather than gallons. A gallon of LP weighs 4.24 pounds. LP tanks can only be filled to 80% of their total capacity, so your 130-pound tank would actually hold 104 pounds, or about 24.5 gallons.

To find out how long a gallon of LP gas will last, you should determine the total BTU **input** on all your LP gas appliances in use. Let's say you have a furnace that has a 10,000 BTU **input** per hour of operation. A gallon of LP gas would last 9.2 hours of continuous operation (92,000 BTU's ÷ by 10,000 BTU's = 9.2). To estimate how long a gallon of LP gas lasts, try to determine what your total daily BTU input is, then divide into 92,000 to arrive at an approximate daily LP gas consumption.

### LP TANK SYSTEM

The storage reservoir for the LP gas system is a horizontally mounted tank which is permanently attached to the vehicle frame. The tank is accessible only from the outside of the vehicle. The tank supply valve is located near the top center of the tank, next to the regulator. Before opening the supply valve, check to be sure all controls for gas appliances are in the "Off" or "Pilot Off" position. If this step is not performed, LP gas could accumulate inside the motor home creating a fire or explosion hazard.

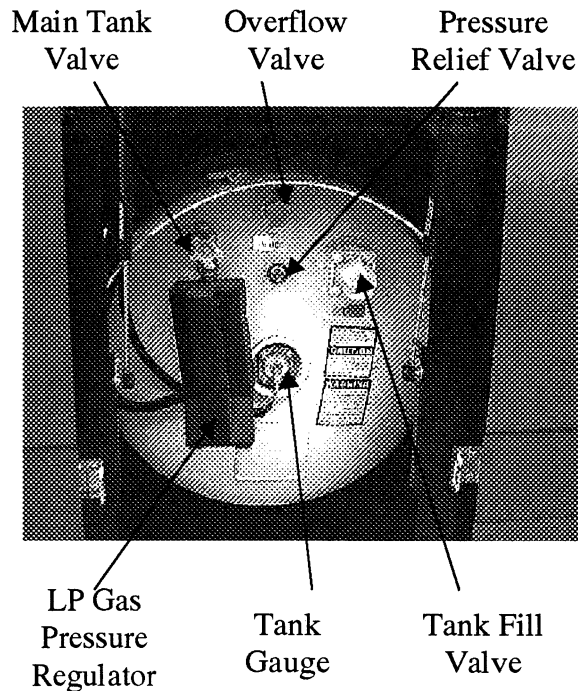

### REFILLING LP TANK

There are many LP gas refueling stations located throughout the country. These stations are listed in the telephone directory Yellow Pages under "Gas - Liquefied Petroleum - Bottled and Bulk."

Since the LP tank is permanently mounted to the frame, the motor home must be taken to an LP dealership for filling. Do not attempt to remove the LP tank from the vehicle. The tank is equipped with a fill adapter with both internal and external threads which allows easy filling with any LP filling equipment. The tank is full when liquid LP gas appears at the overflow valve.

*NOTE: The LP tank is equipped with an automatic 80% stop-fill device.*

**LP Gas Tank Capacity\*** ..... 25.7 gal./109 lbs.

\* Approximate usable tank volume is 80% of total tank capacity. LP gas tanks are sometimes listed in pounds rather than gallons. For reference, a gallon of liquid propane gas weighs 4.24 pounds, and a gallon of liquid butane weighs 4.84 pounds.

## WARNING

Make sure the filling attendant uses the 80% overflow valve when filling the tank. A tank should never be filled above 80% level to allow for vaporization and liquid expansion.

Do not place LP gas containers inside the vehicle. LP gas containers are equipped with safety devices which relieve excessive pressure by discharging gas to the atmosphere.

Do not place LP gas containers, gasoline, or other flammable liquids inside the vehicle. Fire or explosion may result

## AIR IN THE LP GAS TANK

If your LP gas appliances do not stay lit or require frequent adjustment, even though you know the LP tank contains sufficient fuel, the problem may be air in the LP gas tank. Air in the tank mixes with the LP gas vapors causing them to burn poorly. This condition could linger for weeks if the air is not purged from the tank. Most LP gas dealers have equipment for purging air from LP gas tanks and will purge before refilling the tank.

## TRAVEL WITH LP GAS

It is illegal for vehicles equipped with LP tanks to travel on certain roadways or through certain tunnels in the U.S. To avoid inconvenience, check state regulations concerning flammable gas transportation.

## WARNING

Do not alter or remove LP tank gauge at any time.

## WARNING

**DO NOT FILL CONTAINER TO MORE THAN 80 PERCENT OF CAPACITY.** Make sure the motor home is level when filling. It is possible to accidentally overfill the tank if the vehicle is unlevel, with the fill valve on the uphill side. Overfilling the LP gas tank can result in uncontrolled gas flow, which can cause fire or explosion. A properly filled container will contain approximately 80 percent of its volume as liquid LP gas.

**All pilot lights must be extinguished** and supply valve closed before refilling LP gas tanks or vehicle fuel tanks.

**Do not smoke or expose an open flame** while near an LP refueling area. LP gas is heavier-than-air and extremely flammable.

**Never use an open flame** to test for LP gas leaks.

Replace all protective covers and caps on LP system before filling.

**Never fill the LP tank with engine or generator running.**

## REGULATOR

The pressure regulator is protected from the elements by a plastic cover which should be left in place at all times. Only your dealer or a qualified LP gas service should remove the regulator cover for adjustments.

### WARNING

Inspect the pressure regulator vent hole periodically for blockage. If any obstruction is apparent, have the regulator serviced by your dealer or a qualified LP gas service center.

LP gas regulators are installed with the diaphragm vent facing downward. Make sure that the regulator vent always faces downward to minimize vent obstruction which could result in excessive pressure, causing a fire or explosion.

Regulator freeze-ups are caused by the presence of moisture in fuel. This moisture will pass through the cylinder valve and into the regulator where it can freeze. Fuel producers, tank and bottle manufacturers and LP gas dealers take every precaution to reduce moisture, but sometimes only a fraction of an ounce entering the tank can cause problems. To help avoid the possibility of freeze-up, always keep tank control valve closed when not in use, even when tank is empty, to prevent moisture from collecting on the inside.

If regulator freeze-up should occur, you may attempt to thaw the regulator using a light bulb. **DO NOT USE AN OPEN FLAME OR HEAT LAMP.**

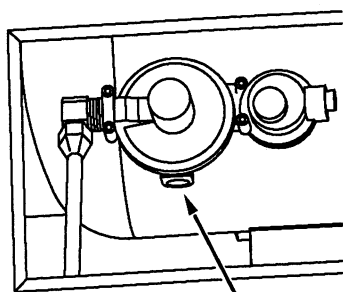

Vent Hole

Typical LP Pressure Regulator

If moisture begins to cause problems, have your LP gas dealer inject a small amount of dry methyl alcohol in your tank (approximately one

once to 20 pounds or one pint to 100 gallons) to help guard against regulator freeze-ups.

In very cold weather when a large volume of gas is being used for heating, it is possible to experience a loss of gas pressure. At first, this problem may appear to be caused by a regulator freeze-up, but is actually caused by failure of the liquid gas to vaporize as fast as it is needed. As the temperature becomes colder, it is increasingly harder for the liquid LP gas to vaporize. At the same time, the demand for LP to produce heat increases to the point where the system cannot maintain production.

The only solution to this problem is to reduce the consumption of gas where possible. Adjusting the temperature on the gas/electric refrigerator may be a first step. Using less hot water will help as well.

### LP GAS LEAKS

The following label has been placed in the vehicle near the range area. If you smell gas within the vehicle, quickly and carefully perform the procedures listed.

#### IF YOU SMELL GAS

1. Extinguish any open flames, pilot lights and all smoking materials.
2. Do not touch electrical switches.
3. Shut off the gas supply at the tank valve(s) or gas supply connection.
4. Open doors and other ventilating openings.
5. Leave the area until odor clears.
6. Have the gas system checked and leakage source corrected before using again.

### WARNING

Never use an open flame to test for gas leaks. When testing for gas line leaks with a soapy water solution, **DO NOT** use a detergent containing ammonia or chlorine. These substances may generate a chemical reaction causing corrosion to gas lines, resulting in dangerous leak conditions.

**LP GAS ALARM** - See page 1-2.

## WINTER USE OF LP GAS

Due to vaporization characteristics of LP gas, it is important that the winter camper knows how to most efficiently use the LP system. The vaporization rate of LP gas decreases in a direct relationship to a decrease in temperature. As explained in the "Selecting Fuel Types" section, butane does not vaporize below 32° F, so propane must always be used in cold climates. However, even propane vaporizes at a slower rate as it becomes colder.

The greater the amount of liquid gas in the tank (up to 80% level) the greater the amount of LP gas vapor generated. The following is an example of the number of BTU's available from an 84-pound tank at 0° F at three levels. As you can see, the number of BTU's decreases as the tank is emptied. Nearly twice as many BTU's are available from a full tank than one that is one-fourth full.

| <b>BTU's Available at 0° F.</b> |              |
|---------------------------------|--------------|
| <u>Tank Level</u>               | <u>BTU's</u> |
| 80%                             | 64,000       |
| 50%                             | 50,400       |
| 20%                             | 33,000       |

The following LP Gas Vaporization and Temperature Relationship chart typifies the LP gas loss with a decrease in temperature. The percentage figures are the increase or decrease of vapor that would be available at 0°F. These figures apply to any size LP gas tanks.

| <u>Temperature</u> | <u>Percentage of BTU's Available at 0° F.</u> |
|--------------------|---|
| 20° F.             | 200%  |
| 10° F.             | 150%  |
| 0° F.              | 100%  |
| -5° F.             | 75%   |
| -10° F.            | 50%   |
| -15° F.            | 25%   |
| -20° F.            | 12 1/2%                                       |
| -44° F.            | Propane will not vaporize                     |





(See also Safety Precautions, Section 1 of this manual.)

Your coach is equipped with an electrical system consisting of two separate voltages; a 12-volt DC system and a 110-volt AC system. The 12-volt system consists of two internal power sources, while the 110-volt system is operated from an outside power source or the optional 110-volt generator. All systems operate through a single power converter control center to provide electrical power to the motor home.

### 110-VOLT AC SYSTEM

The 110-volt system operates from an outside 110-volt utility service such as those at campgrounds, or from the optional 110-volt generator. When the power cord is connected to an outside power source, or when the generator is in operation, the power converter automatically changes a portion of the 110-volt current to 12-volt DC current. All equipment in the motor home that is normally powered by the auxiliary battery is then powered through the converter.

In addition, the following equipment is entirely dependent on the 110-volt generator or shoreline: central air conditioner, refrigerator (when placed in 110-volt mode), microwave oven, ice maker, vacuum cleaner and other 110-volt electrical equipment used at convenience outlets.

### EXTERNAL POWER CORD (Shoreline)

The external utility power cord (commonly referred to as a "shoreline") is stored in the utility compartment on the left (driver's) side of the coach.

#### WARNING

**Do not** connect the external power cord to any receptacle **until** you have contacted the owner and/or attendant of the premises to verify proper polarity and grounding.

It is the responsibility of the owner of the electrical receptacle to ensure that the receptacle is properly wired and grounded.

Reverse polarity and improper grounding of the vehicle can cause personal injury or death.

The power cord is designed to ground the electrical system through the receptacle. It is also designed to carry the amperage output of most campground outlets. If the electrical receptacle to be used is designed to mate with the prongs of the power cord plug, the electrical connection can be expected to carry rated load.

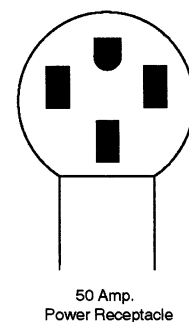

The 50-amp shoreline gives your coach extra current handling capacity. This allows you to run the central air conditioning system at maximum (both compressors running) without fear of constantly tripping circuit breakers.

## AIR CONDITIONER POWER SWITCH

*NOTE: Some parks and campgrounds do not have 50-amp service available, so you will need to connect to a standard 30-amp service pole using an adapter.*

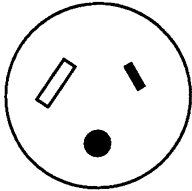

30 Amp Receptacle

You must also place the 30/50 Amp Air Conditioner Power Switch in the 30-amp operating position. This prevents nuisance tripping of the breaker on the service pole.

The A/C Power Switch is located behind the dark glass door above the microwave oven.

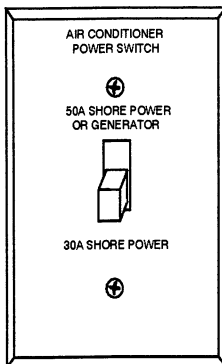

## CONNECTING THE SHORELINE

To connect to an external source, remove the cord from the storage compartment and plug the coach end of the cord into the coach input receptacle. (The coach end is the large, yellow plug.)

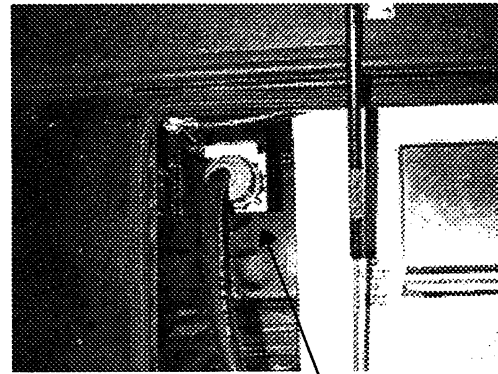

Shoreline Connection

Hold the plug ground-side-down (silver plate on plug) and insert firmly into receptacle. Twist the black retainer collar on the plug handle to lock the plug onto the receptacle during use.

Then plug the shore end of the cord (black plug end) into a suitable 50-amp power receptacle to provide external power to the coach and converter/charger system.

A small hatch in the compartment floor lets you route the shoreline cord out the bottom of the compartment so you can shut the compartment door while the shoreline is connected. Flip the retainers straight up to remove the cover.

### WARNING

**Do not** plug the power cord into an outlet which is not grounded, or adapt the plug to connect to a receptacle for which it is not designed.

Be sure that all three prongs of the supply cord are properly plugged into the receptacle.

**Do not** connect the power cord to an extension cord.

**Do not** plug the power cord into the generator receptacle while the generator is already running

Most campgrounds are equipped with a fuse or circuit breaker at the receptacle. This protects the park's wiring, as well as the power cord on

your vehicle, from electrical damage. If electrical power fails, contact the park attendants and have them check the fuse or breaker for your supply receptacle.

After disconnecting the power cord, neatly replace it in the storage compartment.

### POWER CONVERTER

The power converter changes 110-volt AC current from the auxiliary generator or the shore-line into 12-volt DC current for use by 12-volt equipment in the motor home.

Certain circuits, however, remain unchanged for use by items which require 110-volt current, such as the air conditioner(s), the refrigerator in AC mode, the microwave oven, etc.

Current drawn from the coach batteries passes through the power center unchanged, although it is routed through a series of protective circuit breakers located above the range hood.

*NOTE: The converter will not change 12-volt DC current to 110-volt AC.*

#### WARNING

Do not store anything around or on top of the converter, or in front of the cover. The converter generates heat while operating, and needs unrestricted air flow for proper cooling.

### POWER CONVERTER AND CIRCUIT BREAKER LOCATIONS

The converter system is made up of individual components located in various parts of the coach.

- **Converter Unit (Standard):** The standard 12-volt DC converter unit is located behind a protective panel in the LP gas compartment. There are no user components on this unit.
- **2000W Inverter/Charger Unit (Optional):** The optional inverter/charger is located on the forward wall of the rear right cargo compartment. The inverter/charger has a power/reset switch and two circuit breakers to pro-

tect the inverter and the AC input source from overloads. See the Heart Interface operation information for complete explanation and instructions on this system.

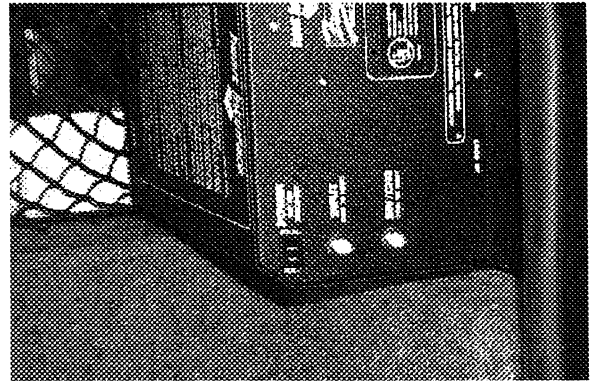

- **Inverter Remote Panel (Optional):** The Heart Interface inverter/charger also has a remote monitor/control panel mounted in the DC load center cabinet behind the black glass door above the microwave oven.

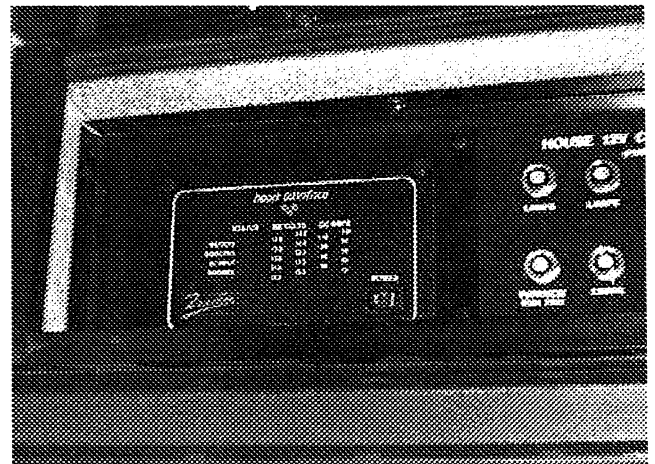

The remote panel can be reprogrammed for several charging configurations using dip switches on the rear side of the panel.

See the Heart Interface remote panel instructions for complete information and specific configuration directions.

*NOTE: The following illustration shows the original factory settings of the dip switches for your reference if you wish to reset to original settings after customizing the charging configuration.*

- 1 - Off
- 2 - On
- 3 - Off
- 4 - Off
- 5 - Off
- 6 - Off
- 7 - Off
- 8 - On

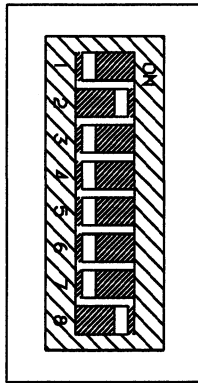

Interface Panel Dip Switches  
Original Configuration

- **12-Volt Circuit Breaker:** The 12-volt breaker panel is located in the DC load center cabinet behind the black glass door above the microwave oven. The panel contains pop-out breakers; push in to reset. The breakers are clearly labeled for the circuits which they protect.

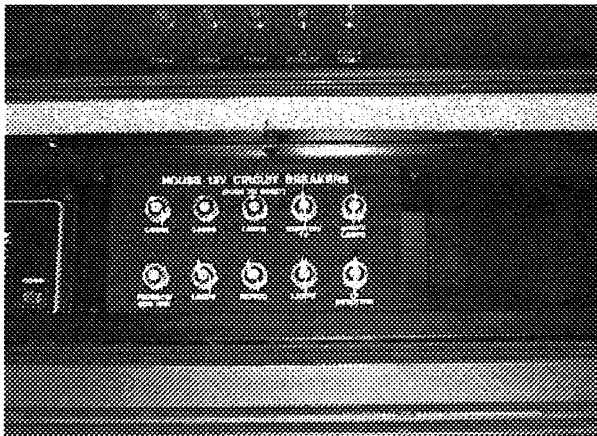

- **Converter Unit (Standard):** The AC breakers are located behind the removable panel in the lower face of the refrigerator cabinet. The toggle style breakers are clearly labeled for the circuits which they protect.

## 110-VOLT CIRCUIT BREAKERS

The breaker panel protects all 110-volt components in the motor home from either an overload on the circuit or a short in the wiring or component itself. When an overload or short develops, the breaker will open preventing any further flow of electricity and, therefore, damage to the system.

Shut off the equipment (example: roof air conditioner) and allow a brief cooling period. Then reset the breaker by moving the switch to “Off” and back to “On”. If the breaker is continually tripped and no overload is evident, have the system checked for a short in the wiring or the appliances.

## CHARGING SECTION

The coach batteries are automatically charged while 110-volt external power is connected. The charger will automatically “sense” the condition of the RV battery. If it is below “full charge”, the Charging Section will start charging the battery.

If the coach batteries have been extremely discharged, they will accept charge at a relatively high amperage rate. If they are only slightly discharged, they will charge at a lower amperage rate. The rate of charge will decrease as the batteries reach “full charge”, then will remain “trickle” charging at a very low amperage rate. If your storage battery does not charge as described above, it is possible the battery is defective.

*NOTE: We do not recommend leaving the shoreline plugged in continuously during storage periods because the batteries can lose electrolytic fluids and become damaged from continuous charging without periodic use. We recommend following regular battery inspection and maintenance, especially in cold weather. See “Battery Maintenance” on page 6-10 this section.*

## THERMAL OVERLOAD PROTECTOR

A thermal overload protector will shut down the converter if it becomes overheated. This can result from operating above its maximum limit for an extended period of time or by obstruction of ventilation to unit.

*NOTE: 12-volt lights and motors will automatically draw from battery power in this event.*

The thermal breaker will reset itself after a cool-down period, and the lights and motors will

resume operating from the converter. If the overload trips again shortly after reset, take immediate steps to correct the cause of overheating. A portion of RV 12-volt load (lights or motors or both) should be turned off to reduce total load. Also, inspect power converter section to make sure ventilation is not obstructed.

*NOTE: The converter will not change 12-volt DC current to 110-volt AC.*

## 110-VOLT RECEPTACLES (OUTLETS)

A number of standard AC electrical outlets are provided throughout the coach for connecting small appliances such as televisions, radios, toasters, etc. An outlet is also located on the outside of the coach near the entrance door.

## GROUND FAULT CIRCUIT INTERRUPTER

Exterior, bath and galley outlets are connected to a GFCI (Ground Fault Circuit Interrupter), which is an extremely sensitive circuit breaker that will help to protect against severe electrical shock if a ground fault develops. If such a condition occurs, the GFCI will break the circuit by turning off the power to the protected outlets. Should this occur, unplug all the appliances on that circuit and press the reset button on the GFCI equipped outlet.

If the GFCI keeps tripping, have the electrical system checked and repaired if necessary before using again.

The GFCI outlet is located in the bath and galley areas of the vehicle.

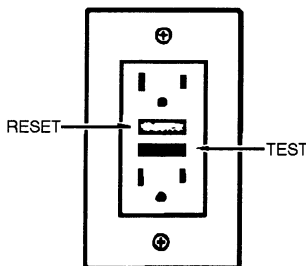

### WARNING

The GFCI will not completely eliminate electrical shock. Small children and persons with heart conditions or other disabilities which make them especially sensitive to electrical shock may still be injured by a 110-volt receptacles even though protected by a Ground Fault interrupter.

*NOTE: In compliance with CSA electrical codes, the appliance outlet in Canadian equipped coaches is not connected to a GFCI protected circuit.*

## AUXILIARY 110-VOLT GENERATOR

### Optional

This coach may be equipped with one of several models of generators. Consult the generator owner's manual in your Motor Home Operations Manual binder for specific instructions on starting and stopping, troubleshooting and maintaining your generator.

*NOTE: Diesel powered generators draw their fuel from the main chassis fuel tank. LP gas powered generators draw fuel from the LP gas tank. After extensive generator use, you may notice decreased levels in the affected fuel tank.*

### WARNING

**Careless handling** of the generator and electrical components can be fatal.

**Never** touch electrical leads or appliances when your hands are wet, or when standing in water or on wet ground.

**Do not** attempt to repair the generator yourself. Service should be performed by an authorized service center.

**Do not** plug the power cord into the generator receptacle while the generator is running.

**Automatic Power Transfer Switch**

Your coach electrical system is equipped with an automatic power transfer switch. The transfer switch is normally in an “off” mode when no AC current is required.

When the generator is started, the transfer unit will switch the power feed to the generator after 10 seconds. The ten-second delay is to allow the generator to start easily without an electrical load.

When the shoreline is plugged in, the transfer unit will automatically switch the power feed connection away from the generator to the shoreline. To use the generator only, unplug the shoreline.

**Generator Power Switches:** For your convenience we have mounted generator power switches in four locations throughout the coach:

- Instrument Panel
- Monitor Panel
- Bedroom (left rear night stand near radio)
- Behind Hood Panel (to right side as viewed looking in)

**Starting The Diesel Generator**

1. Press the left or bottom side of the generator switch and hold for 10-30 seconds to heat the diesel generator engine glow plugs for easier starting.
2. Press the right or top side of the generator switch (ON position) and hold until the engine is running. The switch must be held in position for several seconds after the generator has started to allow the generator to reach full operating voltage.

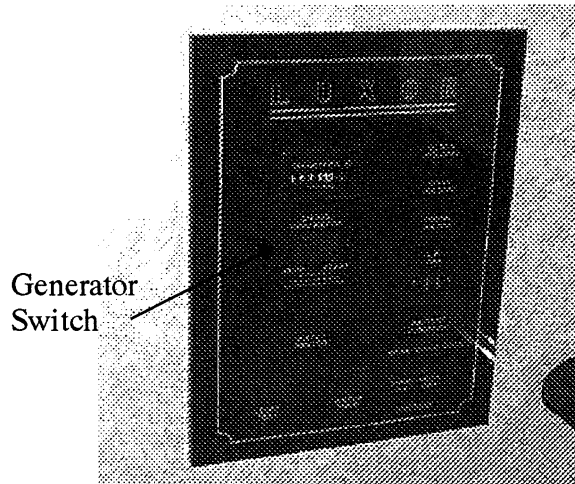

3. Allow the generator to stabilize running before turning on appliances.
4. Apply electrical loads. Refer to **SPECIFICATIONS** section of generator manual for generator set output and performance ratings. Then refer to the following chart to aid in determining appliance usage during generator operation.

**CAUTION**

Continuous generator overloading can cause high operating temperatures that can damage the generator windings. Keep the electrical loads within the generator wattage rating.

| Approximate Power Requirements of Common Appliances |  |
|---|--|
| Appliance or Tool                                   | Approximate Power Consumption (Watts/Amps) |
| Vacuum cleaner                                      | 200-500W/1.7-4.3A                          |
| Coffee Maker  | 550-700W/4.8-6.1A                          |
| Hair dryer  | 800-1500W/7.0-13.0A                        |
| Electric clothes iron                               | 500-1200W/4.3-10.4A                        |
| Electric blanket                                    | 50-200W/0.4-1.7A                           |
| Television  | 80-100W/0.7A                               |
| Electric drill                                      | 250-750W/2.2-6.5A                          |
| Air conditioner                                     | 1400-2000W/13-19A                          |
| Converter   | 300-500W/2.6-4.3A                          |
| Microwave Oven                                      | 700-1500W/6.0-13.0A                        |

## Stopping The Generator

1. Shut off electrical equipment to remove load. Allow generator to run for 3 to 5 minutes to cool down.
2. Press the generator switch into the OFF position and hold until the generator comes to a complete halt.

## Generator Hourmeter

This meter is located on the range hood. It registers the total number of hours that the generator has been operated. Refer to the hourmeter to determine when periodic maintenance is due and to record services which have been performed.

*NOTE: While the generator is running it is normal for the hourmeter to make a periodic "ticking" sound.*

## OPERATION WARNINGS AND CAUTIONS

### WARNING

The exhaust of all internal combustion engines contains carbon monoxide (CO). This poisonous gas is colorless, odorless, tasteless, and lighter than air. The exhaust systems of both your motor home engine and your generator engine have been installed with your safety in mind. However, certain precautions must be taken when using them to protect yourself from conditions beyond the control of the manufacturer.

1. **Do not** simultaneously operate the generator engine and a ventilator which could draw exhaust gases into the vehicle.
2. **Do not** open windows or ventilators on the end or side of the vehicle where exhaust pipe of the generator is located.
3. **Park the vehicle** so that the wind will carry the exhaust away from the vehicle. Also, note the position of other vehicles to be sure their exhaust will not enter your vehicle.
4. **Do not** operate the generator engine when parked if vegetation, snow, buildings, vehi-

cles, or any other object can deflect the exhaust under or into the vehicle.

Check auxiliary generator oil level frequently during periods of use. Refer to the generator manufacturer's information in your Motor Home Operations Manual binder for specific recommendations.

### WARNING

Never check generator oil level while generator engine is running.

**Generator Service Tray Retainers:** The generator service tray is held in by two latches at the front sides of the slide tray assembly.

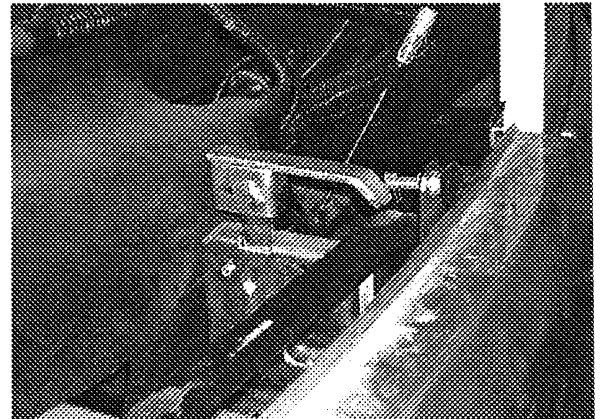

Generator Service Latch - Locked



Generator Service Latch - Unlocked



**CAUTION**

After generator service be sure generator retainers are properly latched to secure generator before driving vehicle.

**12-VOLT DC SYSTEM**

The DC voltage system consists of the automotive batteries and the 12-volt coach auxiliary batteries.

**12-VOLT FUSES AND CIRCUIT BREAKERS**

All 12-volt circuits and equipment in the coach area of the motor home are protected by a circuit breaker panel. When a circuit is overloaded or a short develops in any part of the system, a breaker will shut down that circuit. If this happens, turn off all affected lights or appliances and reset the breaker.

A label on the panel states the amperage rating and circuit protected for each breaker.

The breaker panel is mounted in a cabinet above the rangehood and microwave oven.

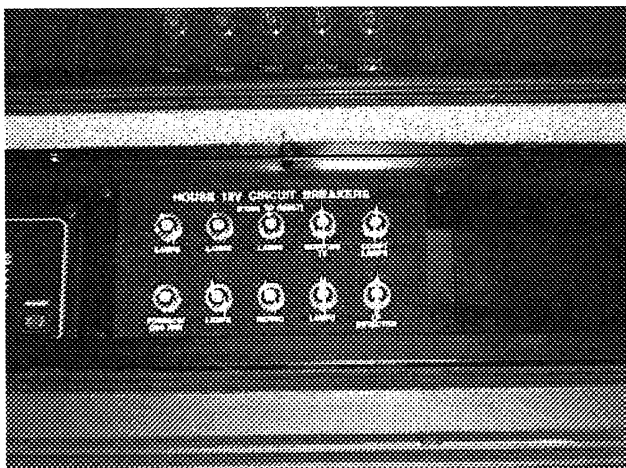

House 12-Volt Circuit Breaker Panel

**12-VOLT CHASSIS CIRCUIT BREAKERS**

The 12-volt automotive and coach circuit breakers are located on a panel on the firewall in the engine compartment. See page 9-7 for further information.

**SOLAR CHARGER PANEL**

The 10-watt roof-mounted solar charger panel uses the sun to help keep your batteries charged. A charge indicator light is located on the refrigerator cabinet wall in the galley area near the dinette table.



Solar Panel  
Charge Indicator

The red light will glow when the solar panel is charging the coach batteries. The greater the rate of charge, the brighter the light. When the batteries reach full charge, the light will gradually dim, then darken.

*NOTE: The solar battery charger is not intended to make the coach battery system "maintenance free." The solar panel will not completely compensate for continuous low amperage draw from components such as the LP gas leak detector, the clock in the dash radio and the radio station memory circuitry, for example.*

*Although the solar panel system can help to extend battery life, the coach shoreline should be plugged in routinely to "top off" the batteries. We also recommend following regular battery inspection and maintenance, especially in cold weather.*



See "Battery Maintenance" on page 6-10 this section.

## BATTERY INFORMATION

### AUTOMOTIVE (Starting) BATTERY

The automotive batteries are used solely to operate the engine starter and all automotive accessories and controls found on the instrument panel. This includes the horn, speed control, all exterior lights, radio, windshield wipers, rear auto heater fan, etc.

**Auto Battery Storage:** The automotive (starting) batteries are located in a slide-out tray in the battery compartment on the right side of the vehicle. (See Exterior Features Identification on page 0-4 of the Introduction section.)

Lift the retainer catches that hold the battery tray and slide it outward for service.

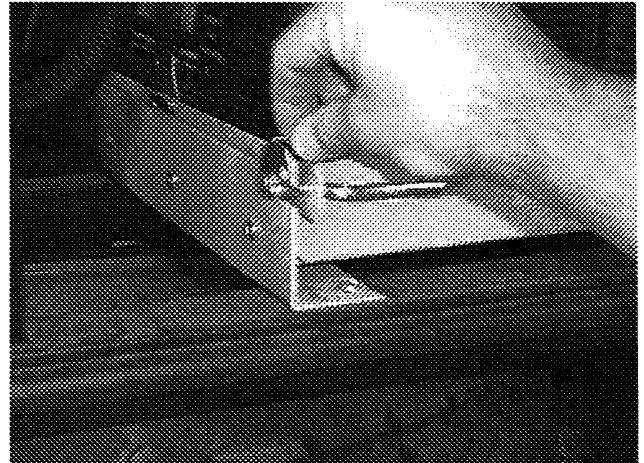

Lift Battery Tray Retainer Latches

### COACH BATTERIES

The coach batteries supply current to all 12-volt equipment located in the living area of the motor home. This includes interior lights, range exhaust fan, furnace fan, water pump, water level and holding tank gauges, 110-volt generator starting, refrigerator, bath roof vent fan, and the rear automotive heater. The coach battery may also be used to start the engine if the automotive battery is dead. Refer to "Aux. Start Switch."

The coach batteries are automatically charged by the engine alternator while the engine is running.

#### Coach Battery Storage

The batteries are also located in the battery compartment on the left side of the coach. See "Auto Battery Storage" for access instructions.

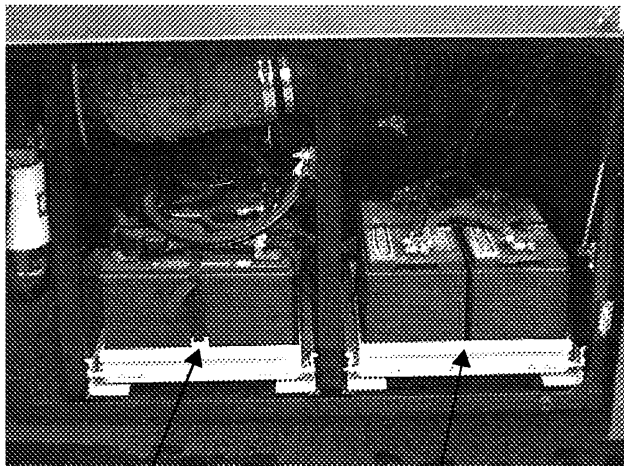

Coach Batteries

Chassis Batteries

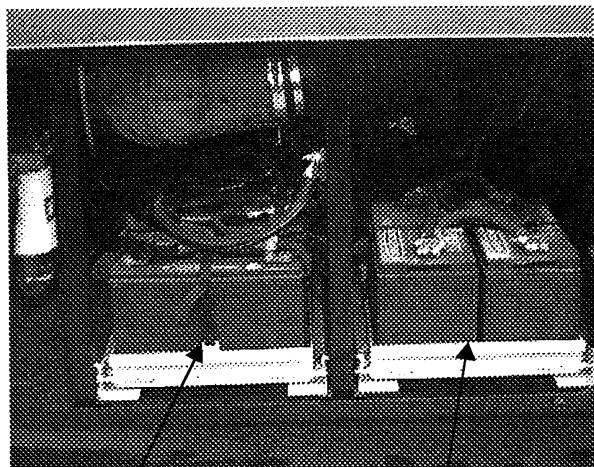

Coach Batteries      Chassis Batteries

### BATTERY STORAGE AND MAINTENANCE

Lead -acid type batteries are electro-chemical devices for storing and releasing electrical charge. As such, they are simply an electrical reservoir, not an electrical source. As soon as energy is removed from the battery, it should be replaced by the engine alternator or the RV converter system.

If a battery sits unused for 30 days or more, especially during warm weather, it can develop a deposit of sulfate crystals on the metal plates inside the battery. This condition is called sulfation or sulfating, and prevents the battery from either releasing or accepting a charge. If this condition occurs, the battery must be replaced.

If a battery does not contain at least 80% charge during freezing temperatures, the electrolyte can freeze and crack the battery case.

The two best defenses against either sulfating or insufficient charge are:

1. To disconnect the battery cables to avoid any "parasitic" discharge, and
2. to check the battery and recharge as necessary at least once a month during long periods of storage.

A further precaution is to remove the battery from the vehicle and store it in a cool location on a wooden or rubber pad, checking charge periodically to avoid discharge or sulfating.

To ensure that the battery will always accept and hold a charge, follow these simple maintenance practices.

- Make sure the batteries always remain securely clamped in the battery tray.
- Make sure battery cable clamps are tight on the terminal posts and are free of corrosion.
- Neutralize corrosion buildup or acid film on top of battery by washing with a baking soda/water solution. Rinse with clear water.

*NOTE: Make sure vent caps are on securely to prevent baking soda solution from entering the battery and contaminating the electrolyte fluid.*

#### WARNING

Before removing any battery cables or battery, make sure all 12-volt equipment in the motor home is off and the power cord has been disconnected.

Replace any damaged cables at once. Always remove jewelry and wear protective clothing and eye covering when checking or handling batteries.

- Clean and tighten battery terminals and have the specific gravity checked at least once a year.
- Every two months, or more often in hot weather, check the battery fluid level. Fill to approximately 3/8 inch above the plates. **DO NOT OVERFILL.** If fluid is added during freezing weather, the motor home should be driven several miles to mix water and electrolyte to prevent freezing.
- Fluid level check may be omitted if equipped with maintenance-free batteries.

**WARNING**

To prevent wiring damage, it is essential when replacing the cables on the battery, or when using a "booster" battery, that the positive post and the positive cable be attached and the negative post and negative cable be attached. The posts are marked (+) plus and (-) minus. If a "fast charger" is used while battery is in the motor home, disconnect both battery cables before connecting the charger. Never attempt to charge or boost a frozen battery.

**COACH BATTERY REPLACEMENT**

This coach is equipped with deep-cycle type batteries designed for recreational vehicle use. They will provide longer lasting power than standard automotive batteries, and will withstand the frequent drain-and-recharge cycles that occur under the demanding conditions of RV usage.

Replacement batteries should be deep-cycle type with equivalent specifications to avoid loss of electrical storage capacity.

- Deep-cycle
- 130 Amp Hr.
- 225 minutes reserve capacity
- 665 CCA (cold cranking amps)

**BATTERY CONDITION METER**

See related item under "Monitor Panel" in section 8, Appliances.

**AUX. START SWITCH**

See section 2, Driving Your Motor Home for information on Aux. Start Switch.

**TRAILER WIRING CONNECTOR**

Your coach is pre-wired for trailer or car towing lights with a 6-pin socket on the rear bumper. The connector plug is supplied in the coach parts package provided to you by your dealer when you took delivery of the vehicle.

The diagram below shows proper connection of trailer or tow vehicle wiring to the coach light system. To access the wire connections inside the plug, remove the small screw near the end of the plug and slide the contact assembly out of the barrel.

- TM = Tail lights
- GD = Ground
- LT = Left Turn
- RT = Right Turn
- S = Brake lights
- A = Backup lights

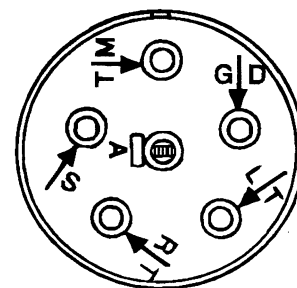



### FRESH WATER SYSTEM

The fresh water system provides water to the galley sink, shower, bathroom lavatory, toilet and water heater. Water may be supplied by either of two sources:

- a water tank located within the motor home, or
- any external water source to which the motor home may be connected, known as "city water".

### FRESH WATER TANK FILLING PROCEDURES:

Always fill the fresh water tank at an approved potable water filling facility or a known purified drinking water source.

You can fill your water tank using either of two methods; gravity fill or city water pressure fill.

**Gravity Fill:** Insert hose into fill opening and turn water supply on. Tank is full when water flows from overflow tube beneath coach. The gravity fill tube is located behind a small, lockable door on the right (passenger) sidewall near the center of the coach.

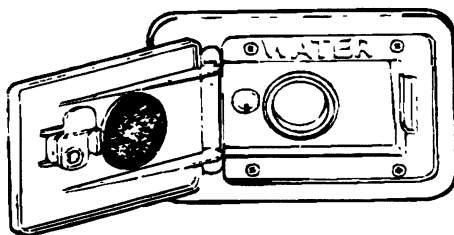

WATER TANK FILL

**City Water Pressure Fill:** Attach hose to city water connector. Open tank fill valve (faucet) inside compartment, then turn water supply on. Tank is full when water flows from gravity fill tube. The city water connector is located in the utility service compartment on the left (driver) side of the coach.

*NOTE: Be sure to open the gravity fill door to prevent pressure build up while filling the tank from the city water connector.*

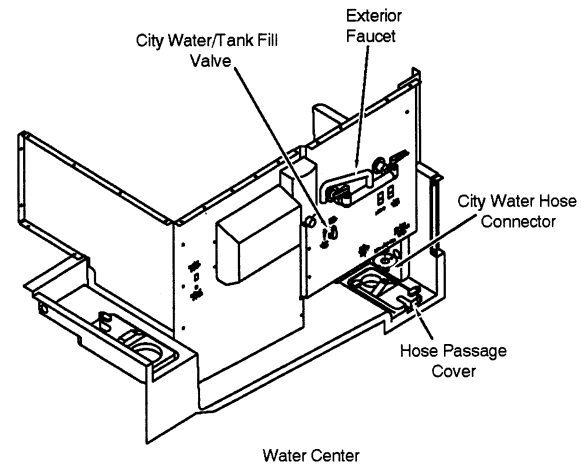

*NOTE: Always keep the tank fill valve closed unless you are filling the tank. If this valve is open while using the city water, the water will keep flowing into the tank and out the gravity fill tube.*

**Fresh Water Tank Capacity: 94 gal.**

### WATER PUMP

Pressure for the water system is supplied by a water system demand pump which is fully automatic after initial priming. When a faucet is opened, the pump begins operation to provide a constant flow from the tank. When the faucet is closed, the pump automatically shuts off.

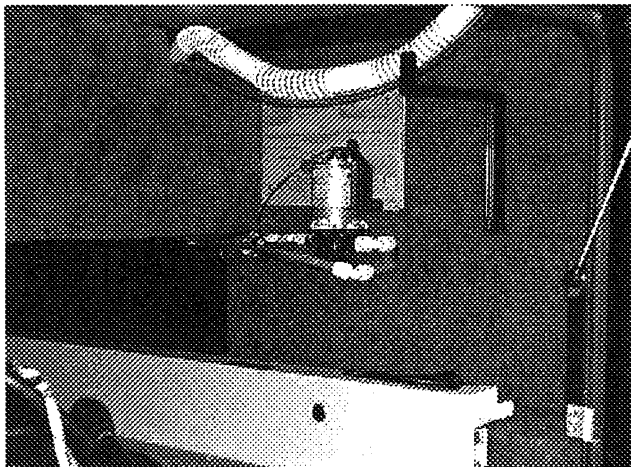

Water Pump  
(behind panel in slideout cargo compartment)

### WATER PUMP SWITCH

Your coach is equipped with water pump switches in three convenient locations:

- on the monitor panel (see section 8)
- in the bathroom
- in the utility service compartment on the outside of the coach

While any pump switch is in the “ON” position, the pump will automatically supply water pressure as it is needed. It is recommended that the pump switch be turned off whenever you are away from the vehicle or not using the water system. A slow leak in a faucet could drain the water system and discharge the coach battery.

### INITIAL START-UP

1. Make sure that all water drain valves are closed, including water heater valve. (Refer to Section 10.)
2. Turn water pump switch to “OFF” position.
3. Fill water tank.
4. Open all faucets, hot and cold.
5. Turn on pump switch.
6. Close each faucet as it begins to deliver a steady stream of water (close cold water first). Leave hot water faucets on until they also deliver a steady stream of water. This will ensure that the water heater is filled with water.

7. Check to be sure pump stops soon after all faucets have been closed.
8. Pump is now ready for automatic operation. Pump will start when a faucet is opened and stop when the faucet is closed.

### ACCUMULATOR TANK

A pressurized accumulator tank is installed in the water line directly upstream from the water pump located behind a protective panel in the slide-out compartment on the driver side of the coach.

The accumulator tank holds a small amount of water under pressure of 20 psi to reduce water line pulsation noise and pressure variations when using the water pump system. This also contributes to longer pump life, less pump cycling, and less amperage draw by the water pump from the coach batteries.

*NOTE: The accumulator tank has a precharge pressure which must be **checked monthly** and maintained at **20 psi** for the system to work properly.*

### Adjusting Precharge Pressure

A tire-type valve stem is provided on the end or top of the accumulator tank to check or add air pressure.

When adding air, do not exceed 20 psi tank precharge pressure because you may risk rupturing the pressure bladder inside the accumulator tank.

Because of the relatively small capacity of the bladder, check pressure with a standard tire pressure gauge before adding air, then if necessary, add air in small bursts, checking pressure between each burst until 20 psi is attained.

Overfilling will also push the bladder too far and reduce the volume of water held in the accumulator tank, making the system inefficient.

The precharge valve stem cap **must be tight** to prevent pressure leak-down.

### Further Information

See manufacturer’s information supplied for your motor home operation manual binder for

complete maintenance instructions and precautions.

### INSTRUCTIONS FOR DISINFECTION OF FRESH WATER SYSTEMS ON RECREATION VEHICLES

#### (As approved by the U.S. Public Health Service)

To assure complete disinfection of your fresh water system, it is recommended that the following procedure be followed on a new system, one that has not been used for a period of time, or one that may have become contaminated. This procedure is also recommended before long periods of storage such as over winter.

1. Prepare a chlorine solution using 1 gallon of water and 1/4 cup of household bleach (sodium hypochlorite solution). With tank empty, pour chlorine solution into the tank. Use 1 gallon solution for each 15 gallons of tank capacity. This procedure will result in a residual chlorine concentration of 50 ppm in the water system. If a 100 ppm concentration is required as discussed in item 3, use 1/2 cup of household bleach with 1 gallon of water to prepare the chlorine solution. One gallon of the solution should be used for each 15 gallons of tank capacity.
2. Complete filling of tank with fresh water. Open each faucet and run the water until a distinct odor of chlorine can be detected in the water discharged. Do not forget the hot water taps.
3. Allow the system to stand at least 4 hours when disinfecting with 50 ppm residual chlorine. If a shorter time period is desired, then a 100 ppm chlorine concentration should be permitted to stand in the system for at least 1 hour.
4. Drain and flush with fresh water.

#### WARNING

Chlorine is poisonous - recap bottle and clean utensils after use.

Never use automotive type antifreeze in your potable water system as it is poisonous.

#### EXTERNAL WATER SUPPLY ("City Water")

##### To connect to an external source:

1. Turn the demand pump switch to off.
2. Attach a hose from the external water source to the city water connection in the utility compartment on the left side of your vehicle.
3. Turn on the external water source.

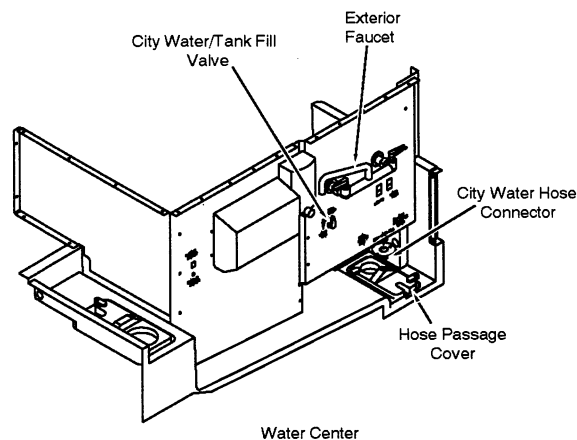

When connected to an outside source of water, the water bypasses the demand pump and storage tank and supplies pressure directly to individual faucets and toilet. A check valve built into the pump prevents water from entering the pump and filling the storage tank.

##### To disconnect from the external source:

1. Turn the external source off.
2. Open a faucet inside the vehicle to relieve line pressure.
3. Disconnect the hose from the vehicle and replace the cap on the connection.

### SHOWER HOSE VACUUM BREAKER

After using the shower, you may notice water dripping from the shower faucet assembly. The dripping results when vacuum in the shower hose (after closing the shower faucet) slowly releases and allows water remaining in the hose to drain down. This is a normal function of the shower valve assembly and is not a leak or defect.

The International Association of Plumbing and Mechanical Officials Standard TSC 21-85 (PAR. 4.3) states:

“Shower heads which incorporate shutoff valves, shall have a minimum “drip rate” of one (1) quart in thirty (30) minutes.”

#### CAUTION

If items are placed into the shower tub before shower valve vacuum release is complete, they may become wet.

The label shown below is attached on or near the faucet to explain the operation of the vacuum breaker assembly.

For your protection, this faucet is equipped with a vacuum breaker (back flow preventer) to prevent contamination of your potable water supply. The water in the hand held shower hose will drain through this vacuum breaker when the faucet is turned off. This is not a leak. This drainage is inherent in the design of the vacuum breaker, and is evidence that it is functioning properly.

P.P.I. 0387

### EXTERIOR FAUCET

The exterior auxiliary faucet feature allows you to do things such as rinse off sand or salt after a swim, rinse off muddy boots, or bathe your pet outside the coach.

It is located in the utility service compartment. For your convenience, there is also a soap dispenser and paper towel dispenser.

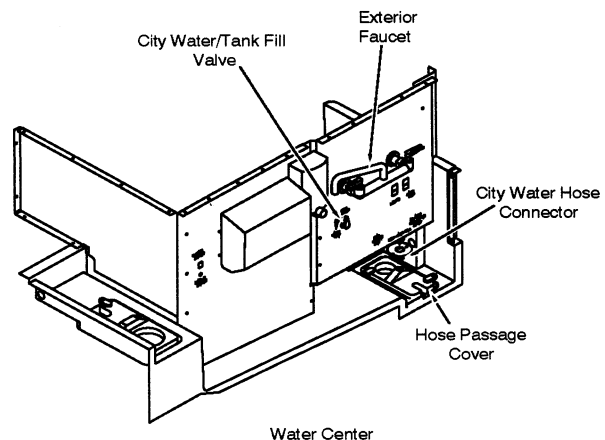

### DRAINAGE SYSTEM WITH TELESCOPING DRAIN HOSE

The drainage system is self-contained, allowing use of the toilet, sinks, or shower even in areas where hook-up is not available.

Your coach is equipped with a convenient telescoping drain hose for easy and sanitary dumping of waste holding tanks. See the Thetford Telescoping Drain Owner's Manual supplied in your Operations Manual binder for complete illustrated instructions on coach positioning and operation of this convenient device.

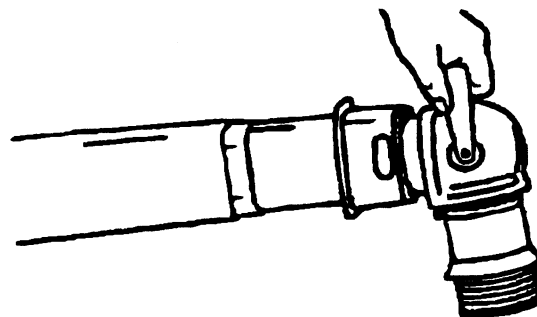

Thetford Telescoping Drain Tube

### DUMPING HOLDING TANKS

1. Deploy the telescoping drain hose and place end of sewer hose into disposal opening.
2. Open the sewage (black) valve with a quick pull. OPEN ONE VALVE AT A TIME. Move hose gently about to dislodge any waste and to ensure complete drainage.



*NOTE: Do not open the gray water valve until the black water tank is drained and dump valve closed to avoid sewage back-up into gray tank. Gray water also rinses any black water solids from the drain hose.*

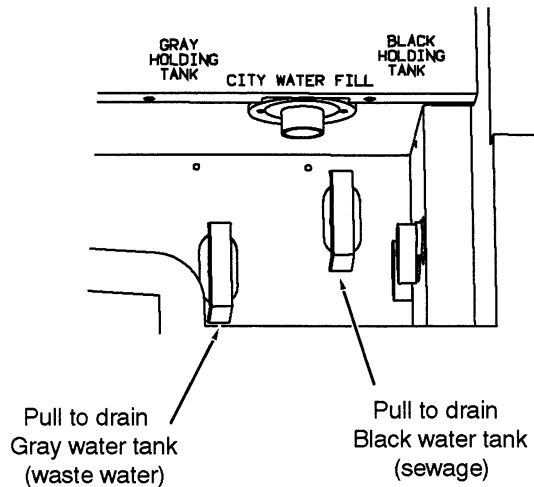

3. Close sewage valve and open waste (gray) water dump valve with a quick pull. Close valve handle as soon as tank is empty.
4. After both tanks have been drained, run several gallons of water into the sewage tank through the toilet. Then open sewage dump valve and drain the tank again. Close valve when done.
5. It is advisable to add an odor control chemical to the sewage holding tank. These chemicals are available at most R.V. stores.
6. Rinse end of sewer hose thoroughly with water; retract and stow.

*NOTE: We recommend that you dump all holding tanks before traveling to avoid carrying unnecessary weight.*

### USING ON-SITE SEWER HOOK-UPS

The drain hose may remain attached to the dump outlet and be routed out the bottom of the compartment while the motor home is parked and connected to an on-site sewage hook-up.

When using a sewer hook-up, keep the dump valves closed until a tank becomes full or when preparing to leave the site. This keeps the solids in suspension, allowing them to be carried out with the liquids when the dump valve is opened.

If the valve is left open, the liquids will drain off, leaving solids in the tank. Should this accidentally happen, disconnect the hose, fill the tank about half full with water, and drive a few miles to dislodge the solids. A few starts and stops will aid in the process. Then reconnect the hose and drain in the normal manner.

### HOLDING TANK LEVEL INDICATORS

The holding tanks may be monitored on the wall mounted monitor center.

Press the "Levels Test" switch to check the level in each tank.

See page 8-7 for further information on the monitor panel.

### WATER DRAIN VALVES

The water drain valves are used to drain water from the water tank and the water supply lines when preparing the motor home for storage or when sanitizing the water system.

#### To Drain Tanks and Water Lines:

The water tank and line drains are located behind an access panel below the city water connector in the utility service (water system) compartment.

- Open both Hot and Cold water line valves.
- Turn water diverter valve to WATER TANK FILL position.
- Open shower line drain valve inside coach. See below.

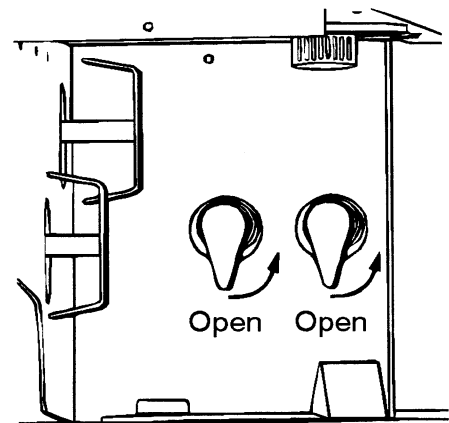

Water Tank & Line  
Drain Valves

Turn the valves to the right (clockwise) all the way to the stop position to open. To close valves, turn all the way to the left (counterclockwise) to the stop position.

**Shower Line Drain Valve:**

To properly winterize the shower, you must drain the line which runs from the shower diverter faucet to the corner spout.

A drain valve is located beneath the removable bottom panel of the bath lavatory on the driver side of the coach.

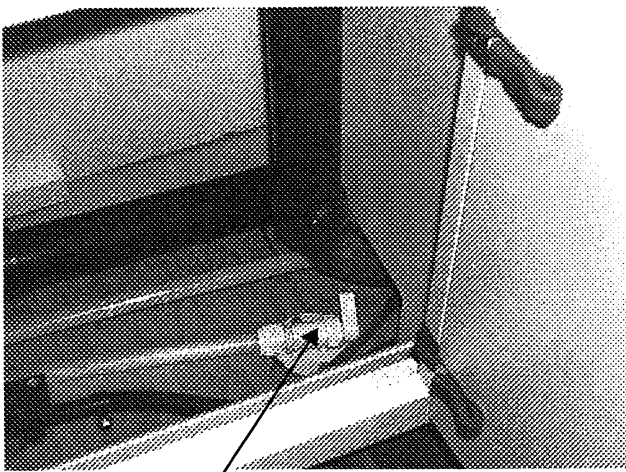

Shower Line Drain Valve  
(shown exposed with bottom panel removed)

Lift the panel and turn the valve as shown in the illustration.

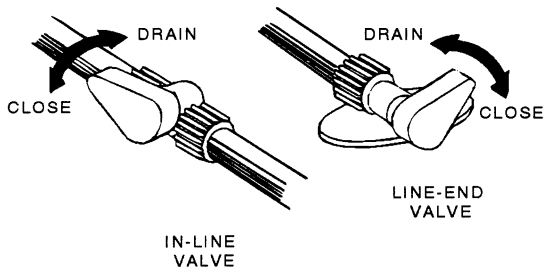

Water Drain Valves  
(typical)

**Water Heater Drain Plug:** The water heater drain plug is located on the outside of the coach behind the water heater service panel. Use a socket to remove the plug.

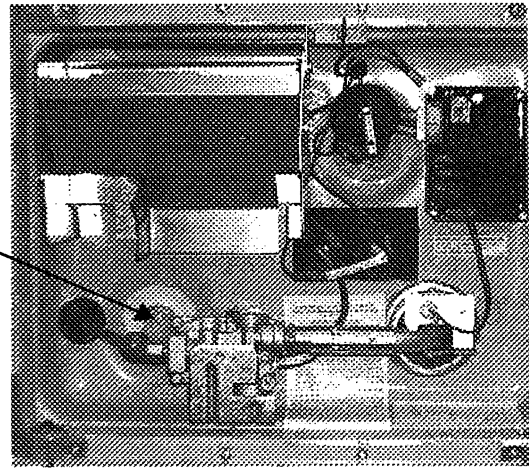

Water Heater  
Service Access

(The water heater by-pass valve is located behind an access panel on the side of the refrigerator cabinet. See pg. 8-12).

**UTILITY LIGHT**

A lamp is located up on the left sidewall to provide light in the utility hook-up area.

The switch is located inside the shoreline/sewage compartment on the left side of the coach.

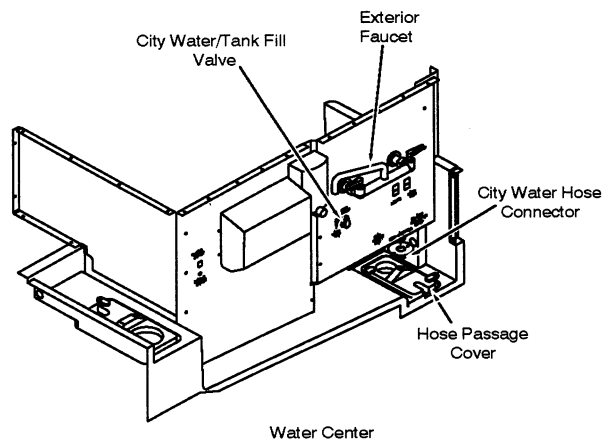

**TANK CAPACITIES**

- Diesel Fuel Tank..... 100 gals.
- LP Gas Tank ..... 109 lbs./25.7 gals.
- Fresh Water Tanks (2 @ 47 gal.) ..... 94 gals.
- Black Water Holding Tank..... 58 gals.  
(Toilet/Washer-Dryer Opt.)
- Gray Water Holding Tank ..... 67 gals.  
(Lavatory/Galley/Shower/Dishwasher Opt.)

(See also Safety Precautions, Section 1 of this manual.)

*NOTE: Some items described in this section may be optional and, therefore, may not be in your vehicle.*

The appliances installed in your motor home are manufactured by reputable RV appliance makers and have been tested by independent laboratories to meet all applicable standards and codes set for RV appliances. These appliances are covered by your New Vehicle Limited Warranty. (Certain items may be covered by individual manufacturer's warranty.) See your New Vehicle Limited Warranty for details.

## REFRIGERATOR

The refrigerator in your coach can be operated from either of two power sources available to the motor home:

- 110-Volt AC electric
- LP gas

The refrigerator is an absorption type which uses an ammonia-water solution for cooling. Basically, ammonia vapor is distilled from the solution by heat, produced from either LP gas or electricity and then carried to the finned condenser where it liquefies. The liquid then flows to an evaporator where it creates cold temperatures through evaporation.

### Leveling

Before operating the refrigerator when the motor home is stationary, place a small level on the freezer plate and make certain the unit is level.

Normal vehicle leveling to provide comfort for the occupants is satisfactory for refrigerator operation. This will be well within the operation limits of 3° off-level side-to-side and 6° off-level front-to-back.

### CAUTION

To prevent permanent damage to the refrigerator cooling unit, turn the refrigerator off if the vehicle will be parked on an incline of **over 3° side-to-side or 6° front-to-rear** (such as steep driveways or parking lots, etc.) for more than one hour.

## DOMETIC MODEL RM7732 SIDE-BY-SIDE REFRIGERATOR

### Operation

Before starting the refrigerator, check that all the manual gas valves are in the ON position. DO NOT forget the manual shutoff valve on the rear of the refrigerator, see Fig. 1.

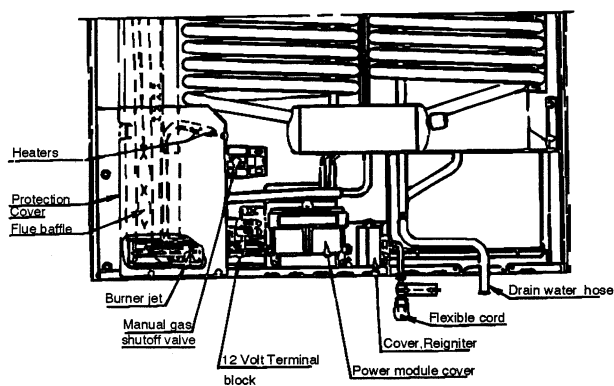

This refrigerator is equipped with an Automatic Energy Selector (AES) control system, which can automatically select the most suitable energy source which is available, either 120 Volt AC, or LP gas operation. The system can be set by the user to be fully automatic, or if desired, LP gas only. The refrigerator controls will work down to 9.6 volt DC.

**WARNING**

Most LP gas appliances used in recreational vehicles are vented to the outside of the vehicle. When parked close to a gasoline pump, it is possible that the gasoline fumes could enter this type of appliance and ignite from the burner flame, **CAUSING A FIRE OR AN EXPLOSION.**

FOR YOUR SAFETY, it is recommended that all LP gas appliances which are vented to the outside should be shut off when refueling.

**DESCRIPTION OF OPERATING MODES**

**AES/AUTO MODE**

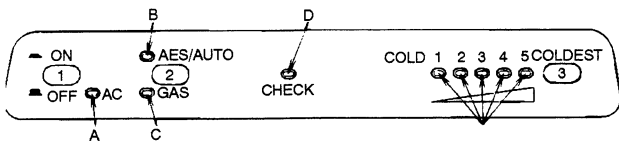

When operating in the AES/AUTO mode, the AES/AUTO indicator lamp (B) will illuminate. The control system will automatically select between AC and GAS operation with AC having priority over GAS. Either the AC indicator lamp (A) or the GAS indicator lamp (C) will illuminate depending on the energy source selected by the control system. If the control system is operating with AC energy and it then becomes unavailable, the system will automatically switch to GAS. As soon as AC becomes available again the control will switch back to AC regardless of the status of GAS operation.

**GAS MODE**

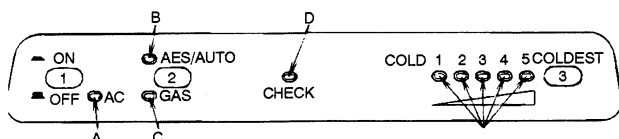

When operating in the GAS mode in the AES/AUTO mode indicator lamp (B) will be off and the Gas mode indicator lamp (C) will be illuminated. This mode provides LP gas operation only. The control system will activate the ignition system and will attempt to light the burner for a period of approximately 45 seconds. If unsuccessful, the CHECK indicator lamp (D) will illuminate and the GAS mode indicator lamp (C) will turn off.

To restart GAS operation, press the main power ON/OFF button (1) to the OFF and then ON position. The control system will attempt a new 45 seconds ignition sequence.

If the refrigerator has not been used for a long time or the LP tanks have just been refilled, air may be trapped in the supply lines. To purge the air from the lines may require resetting the main power ON/OFF button (1) three or four times. If repeated attempts fail to start the LP gas operation, check to make sure that the LP gas supply tanks are not empty and all manual shut-off valves in the lines are open. If the problem is still not corrected, contact a service center for assistance.

If the control is switched to AC operation while the CHECK indicator lamp is on, it will function properly, but the CHECK indicator lamp will not go off until the main power ON/OFF button is pressed to the OFF then ON position.

**LIMP MODE OF OPERATION**

This control system contains a feature where it will continue to operate the cooling system in the event of a failure of a major operating component. Two different modes of operation can occur in this category.

If for some reason the display module becomes non functional, the control system will revert to full automatic operation selecting the best energy source available with AC, GAS priority. The temperature of the refrigerator will be maintained at the MID position within normal temperature tolerances. The power module will continually attempt to reestablish operation of the display module.

The second limp mode of operation will execute when a failure of the temperature sensing device or associated electronic circuitry occurs. If this should occur, the control system will operate on the energy source selected via the control panel. The cooling unit will run continuously on the selected energy source. The refrigerator will continue to operate in this mode indefinitely or until a new sensor is installed and the system is reset.

## HOW TO USE THE REFRIGERATOR

### FOOD STORAGE COMPARTMENT

The food storage compartment is completely closed and unventilated, which is necessary to maintain the required low temperature for food storage. Consequently, foods having a strong odor or those that absorb odors easily should be covered. Vegetables, salads, etc. should be covered to retain their crispness. The coldest positions in the refrigerator are under the cooling fins and at the bottom of the refrigerator. The warmer areas are on the upper door shelves. This should be considered when placing different types of food in the refrigerator.

When the refrigerator is heavily loaded, it will take a longer time to lower the temperature; therefore, to get maximum efficiency the refrigerator and food items should be pre-cooled prior to loading. The shelves should not be covered with paper or plastic, and the food items should be arranged so air can circulate freely. Two door shelves are equipped with fingers. The fingers are designed to prevent large containers (1/2 gallon milk or juice) from shifting or spilling while traveling.

### FROZEN FOOD STORAGE COMPARTMENT

Quick frozen soft fruits and ice cream should be placed in the coldest part of the compartment, which is on the top freezer shelf. Frozen vegetables may be stored in any part of the compartment.

This compartment is not designed for deep or quick freezing of food. Meat or fish, whether

raw or prepared, can be stored in the frozen food storage compartment provided they are pre-cooled first in the refrigerator. They can be stored about three times longer in the frozen food compartment as compared to the fresh food compartment. To prevent food from drying out, keep it in covered dishes, containers, plastic bags or wrapped in aluminum foil.

#### Refrigerator volume

The combined volume of the freezer and fresh food compartment are 9.2 cubic feet for the model RM 7732.

### ICE MAKING

Ice cubes can be made in the ice trays placed in the freezer compartment. The trays should be filled with water to within 1/4" (5 mm) from the top. For faster ice making, the trays should be placed in direct contact with the freezer shelves.

To release the ice cubes, seize the tray with both hands and twist the tray. Cubes not required should be replaced in the tray. Refill the tray with water and replace the tray on the freezer shelf.

Ice will be made more rapidly if the thermostat is set at its highest position.

It is a good idea to do this a few hours before the anticipated need for ice, but be sure to move the thermostat back to normal setting, usually about mid setting when the ice is formed. Food in the lower compartment may be frozen if the setting is left on "COLDEST" position.

### DEFROSTING

Shut off the refrigerator by pressing the main power ON/OFF button to the UP (OFF) position.

Empty the refrigerator, leaving the drip tray under the finned evaporator, and the cabinet and freezer doors open. Defrosting time can be reduced by filling the ice trays with hot water and placing them on the freezer shelves.

When all the frost has melted, dry the interior of the refrigerator and freezer with a clean cloth. Replace all food and set the thermostat to the COLDEST temperature setting for a few hours. Then reset the thermostat to the desired setting, usually at mid setting.

**CAUTION**

DO NOT use a hot air blower. Permanent damage could result from warping the metal or plastic parts. DO NOT use a knife or an ice pick, or other sharp tools to remove frost from the freezer shelves. They can create a leak in the ammonia system.

**CLEANING**

Cleaning the refrigerator is usually done after it is defrosted or put into storage. To clean the interior liner of the refrigerator, use lukewarm weak soda solution. Use only warm water to clean the finned evaporator, ice trays and shelves. NEVER use strong chemicals or abrasives to clean these parts as the protective surfaces will be damaged. It is important to always keep the refrigerator clean.

**SHUT OFF - STORAGE PROCEDURE**

Shut off the refrigerator by pressing the main power ON/OFF button to the UP (OFF) position.

If the refrigerator will not be in operation for a period of weeks, it should be emptied, defrosted, cleaned and the doors left ajar. The ice trays should also be dried and kept outside the cabinet.

**CAUTION**

DO NOT store explosive substances in the refrigerator, such as cigarette lighter gas, petrol, ether or the like.

**CLIMATE CONTROL HEATER**

During the summer months of high temperatures and humidity, the metal frame between the freezer and fresh food compartments may have water droplets forming. The number of water droplets will increase if the vehicle isn't air conditioned during these months.

This refrigerator comes standard with a 12 volt (DC) climate control that will evaporate the water droplets when they form

To have the climate control on, you position the switch ("F" see illustration) located behind the freezer door to ON. The climate control can be left on continuously or only used when temperatures require it.

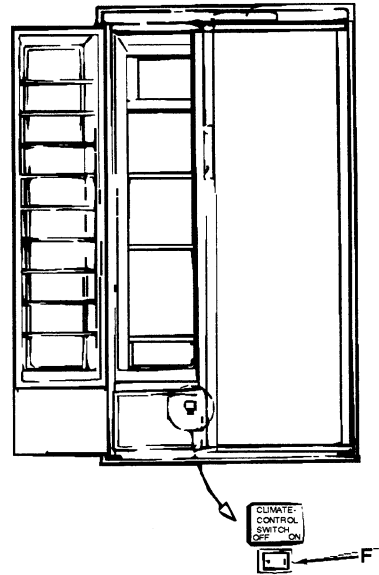

*NOTE: The climate control will draw 12 volts DC power continuously when in the ON position. It should be turned OFF when a charging source is not available.*

**OPERATING INSTRUCTIONS**

**Norcold 900-Series Models with Electronic Auto Mode Control**

The control panel is located between the freezer compartment and fresh food compartment. It contains pressure sensitive touch switches and an LCD display (B). A backlight illuminates the display for 10 seconds whenever any of the control buttons is pressed.

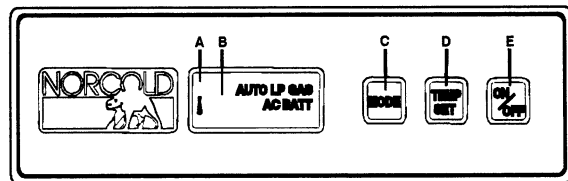

The ON/OFF button (E) turns the refrigerator on or off. If the button is pressed, it will turn the refrigerator on and set the mode to auto. When the refrigerator is on, pressing this button for 2 seconds will turn the refrigerator off.

Pressing and holding the MODE button (C) allows the user to cycle through the three mode choices; one AUTO and two manual modes (AC,

LP GAS). The refrigerator will not switch to the new operating mode until the mode button is released.

The TEMP SET (thermostat) button (D) controls the refrigerator and freezer temperature during both gas and electric operation, eliminating the need to reset each time a different power source is selected. Press and hold the TEMP SET button to select the desired temperature setting. The temperature settings are shown in the form of a thermometer (A) in the display window, with the shortest thermometer reading indicating the coldest setting.

### Start-Up Instructions - Auto Mode

When the AUTO mode is selected, the operating control automatically selects the power source using the following priority scheme:

- When 120 volts AC is available to the refrigerator, AUTO AC will be visible in the display panel, indicating the refrigerator is operating on AC electric.
- If 120 volts AC is not available, the refrigerator will switch to the gas operation, and AUTO LP GAS will be visible in the display panel.

During operation in the AUTO mode, when a higher priority power source becomes available, the operating controls will cease using the current power source and will switch to the higher priority power source. For example, if AC electric becomes available while the refrigerator is operating in the AUTO LP GAS mode, the refrigerator will switch to AUTO AC operation.

If an operating mode is not functional, a diagnostic code will appear and the refrigerator will attempt to operate in a lower power priority source. If a lower power priority source is not available, an alarm will sound and the refrigerator will cease operation. Refer to the *Diagnostic Codes and Their Meaning* for corrective actions.

### Start-Up Instructions - Manual Mode

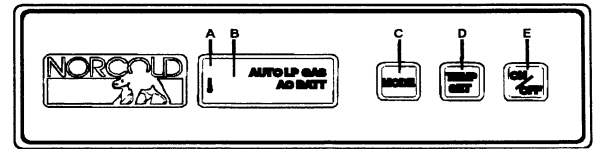

To operate in the MANUAL mode, press and hold the MODE button (C) until AUTO disappears and the desired operating mode is displayed. If the power source is interrupted while operating in the MANUAL mode, a diagnostic code will appear, an alarm will sound, and the refrigerator will cease operation. For corrective actions, refer to the *Diagnostic Codes and Their Meaning* on page 10 of the Norcold Operator's Guide in the blue binder.

### AUTO and MANUAL Modes - Gas Operation Only

If the gas does not ignite within 30 seconds, which may occur on initial start-up, the refrigerator's gas valve will automatically close and the operating controls will select an alternate power source (AUTO Mode) or MANUAL mode, will revert to a stand-by mode in which an alarm will sound and code A1 will be displayed in the center window. The alarm and code will remain on until the operating controls are turned OFF and then ON again. If the gas does not ignite after several attempts, check the input gas supply, or consult with your dealer or a Norcold authorized service center. A different mode of operation may be selected by pressing and holding the MODE button. The refrigerator will not switch to the new operating mode until the MODE button is released.

### Backup Operating System (BOS)

Your refrigerator features a Backup Operating System which keeps the refrigerator cool in the event of a failure of the refrigerator's operating controls. If a failure occurs, the refrigerator will display Diagnostic Code C5 and will switch automatically to the BOS mode. This mode provides refrigeration until the refrigerator is serviced. The fresh food and freezer compartment temperatures should be monitored to prevent

over-freezing or thawing of refrigerator contents when operating in the BOS mode. If the refrigerator temperature is too cold, adjust the thermostat up (warmer) in one bar increments. If the refrigerator temperature is too warm, adjust the thermostat down (colder) in one bar increments. Let the refrigerator operate at the new setting for one hour before rechecking the freezer and fresh food compartment temperatures. (Frequent door opening prevents the temperatures from stabilizing.) Although the refrigerator can operate in this mode, Norcold recommends that you seek service to restore normal operation as soon as practical.

### Humidity - Storage Switch

Turning this switch to HIGH HUMIDITY will keep the surface between the door openings dry during high humidity conditions. The switch should be left in the NORMAL OPERATION position unless moisture collects around the door.

When storing your RV for the winter, place this switch in the STORAGE (LIGHT OFF) position. This shuts off all DC power to the light and humidity heater and allows the refrigerator door to be left open for airing without draining the battery.

### Operating Tips

- The refrigerator should already be cold before placing items in it.
- Food and beverages should also be cold before placing in RV refrigerator. Never put warm or hot items in a cold refrigerator.
- Do not pack the refrigerator too full. The refrigerator needs room for cold air to circulate.
- Use smaller containers for each item. (e.g. a half gallon container of milk instead of a half-full gallon jug)
- Always put foods, especially liquids, in tightly sealed containers.
- Use crumpled paper between loose items to reduce rattling or “clinking” noises.

### ICE MAKER - Norcold

Some Norcold refrigerators are optionally equipped with an automatic ice maker system. The ice maker unit is installed in the freezer compartment of the refrigerator.

The ice maker does not freeze the ice. The refrigerator freezer compartment does the actual freezing of the water. The ice maker simply senses when the ice is ready, ejects it into the ice bin, and refills the molds with water for another ice cycle. When the ice bin is full, the amount of ice will raise an automatic shutoff arm which stops the ice maker. Some problems involving lack of ice production - particularly a lack of freezing - may be the fault of the refrigerator rather than the ice maker.

### Operating the Ice Maker

1. Connect the coach shoreline to a 110VAC source and switch the refrigerator to AUTO (AC electric) mode. The ice maker motor runs on 110-volt current only.
2. Connect the coach to an external (city water) source or leave water pump switch on continuously to provide a constant water supply.
3. Be sure the ice bin is in place and the ice maker's automatic shut-off arm (wire) is in the down (automatic) position. If the arm is up, the ice maker will not operate.

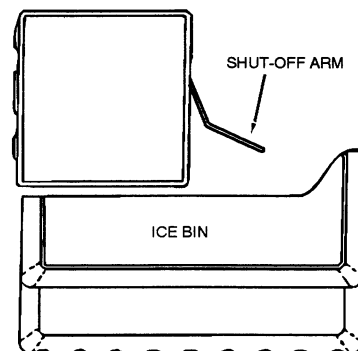
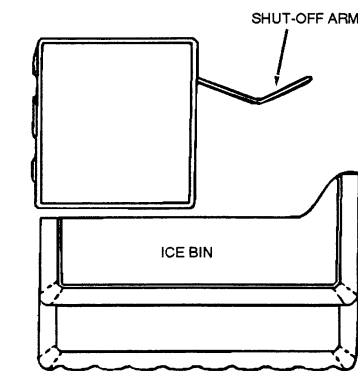



4. Start the refrigerator the day before ice cubes are needed. When the refrigerator is started (from room temperature), it is normal to take as long as 24 hours to become cold enough to make the first batch of ice cubes.
5. Always discard the first batch of cubes made in a new ice maker. The new plumbing lines and connections may cause discolored and bad tasting ice. The ice maker will make up to 3 lbs. of ice in 24 hours, if the freezer temperature is 14 F or below.
6. To remove the ice bin, raise the automatic shut-off arm (off). When returning the ice bin to the freezer, remember to lower the shut-off arm (on). If the arm is up, the ice maker will not operate.

#### Shut-Down of Ice Maker

To turn the ice maker off, simply raise the shutoff arm.

#### Winterizing the Ice Maker

When winterizing, make sure the water line is completely drained by following this procedure.

1. Drain coach water lines. See Sect. 10.
2. Open drain valve at the rear of the refrigerator (on outside of coach).
3. Let the ice maker run through a cycle, then move the shut-off position.
4. Drain water again at the refrigerator drain

#### Start-Up (Removing from Storage)

1. Close all drain valves.
2. Turn the water supply on.
3. Be sure the ice bin is in place and the automatic shutoff arm is down.
4. Let the refrigerator cool down to ice making temperature. Remember, this can take up to 24 hours.
5. Let the ice maker cycle and dump the first batch of ice.

#### Troubleshooting the Ice Maker

1. **Is 110-Volt AC reaching the refrigerator?**
  - A. Ice maker motor needs 110VAC to operate.

- B. Be sure refrigerator power cord is plugged in.
  - C. Check appropriate breaker on 110VAC breaker panel.
2. **Is 12-Volt DC reaching the refrigerator?**
  - A. Refrigerator eyebrow control and power supply board both need 12VDC to operate.
  - B. Check 12V fuse or breaker on converter panel
3. **Is water supply pressure at least 15 psi, but no more than 125 psi?**
  - A. If not enough, turn city water faucet open further or check for blockage.
  - B. If too much, attach water pressure regulator.
4. **Is the water supply inlet valve on?**
  - A. If not enough, turn city water faucet open further or check for blockage.
  - B. If too much, attach water pressure regulator.
5. **Is the freezer compartment temperature 14° F or lower?**
  - A. Turn refrigerator temperature control to colder setting, if needed.
6. **Is the ice maker's automatic shut-off arm in the down (on) position?**
  - A. If arm is not down, ice maker will not operate.
7. **Has it been at least 24 hours since the refrigerator was turned on?**
  - A. If not, allow more time.
  - B. If so, refer to Norcold refrigerator freezer troubleshooting procedures in your dealer service library.
8. **Water not filling molds:**
  - A. Water inlet valve off (on back side of refrigerator).
  - B. Insufficient water pressure.
  - C. Water line blockage.
  - D. Faulty water solenoid - stuck off.
9. **Water over-filling molds:**
  - A. Excessive water pressure.
  - B. Faulty water solution - stuck on.
10. **Water not freezing:**
  - A. Refrigerator problem.
11. **Ice not ejecting:**
  - A. 110VAC power not connected.

- B. Mold heater not working - replace ice maker.
- C. Ejector motor not working - replace ice maker.

**12. Ice bin overfilling:**

- A. Shutoff switch broken.
- B. Shutoff wire stuck.

**13. Low ice production:**

- A. Water not freezing fast enough - refrigerator problem.

**14. Freezer needs defrosting often:**

- A. Ice maker motor and mold heater add heat to compartment, which develops frost. This is normal.
- B. Check door gasket for proper sealing.

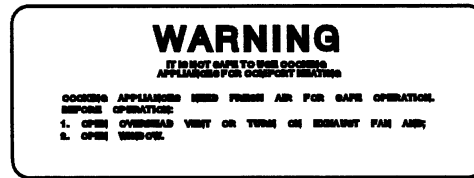

Unlike large homes, the oxygen supply inside a recreational vehicle is limited due to its size. To avoid danger of asphyxiation, provide proper ventilation when using the gas rangetop or gas oven. It is especially important not to use the gas oven and range top for comfort heating. Danger of asphyxiation is greater when these appliances are used for long periods of time.

**REFRIGERATOR COMPARTMENT**

**(Exterior)**

The exterior refrigerator compartment allows access to the rear of the refrigerator for inspection, maintenance and service.

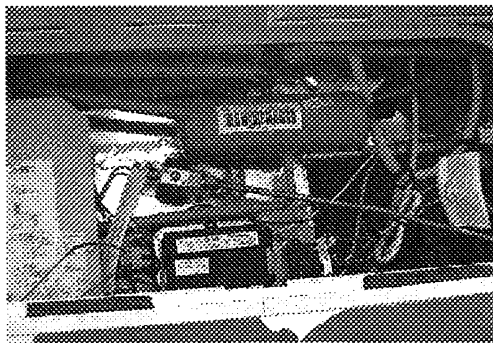

Refrigerator Access Compartment

**RANGE AND OVEN**

The range and oven in your motor home are operated on LP gas and will provide nearly all of the functions that the range in your home does. One benefit of gas burners is that heat is available as soon as a burner is lit, as opposed to an electric element slowly heating up. The range has a "Pilot Off" position on the oven control which allows the oven pilot to be turned off when traveling or refilling the LP tank.

The following warning label has been located in the cooking area to remind you to provide an adequate supply of fresh air for combustion.

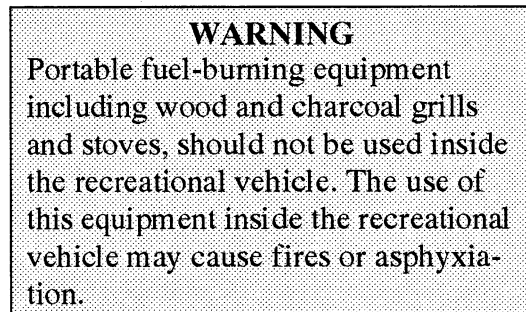

**Lighting Range Top Burners (w/Pilotless Ignition)**

1. Be sure LP gas tank main supply valve is open.
2. Press and turn desired burner knob to HI. You will hear a "snapping" noise as the automatic spark ignition lights the burner.
3. When the burner ignites, turn the knob to the desired flame height setting.

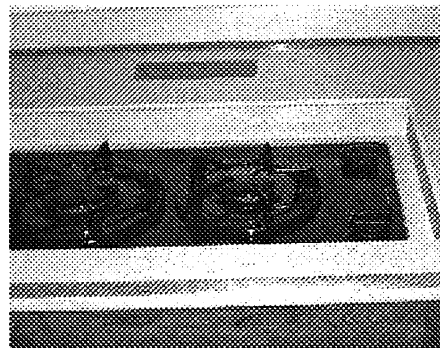

## LIGHTING OVEN PILOT

*NOTE: If range and oven have not been used for a long time, the oven pilot may be slow in lighting because of air in the gas line.*

1. Be sure all valves are in the "OFF" Position. The oven control knob should be in "OFF" position.
2. Turn on main gas supply to range.
3. Press and turn control knob to the "PILOT ON" position. This will allow gas to oven pilot.
4. Open oven door and light oven pilot with a match. Small flame will be noted at the

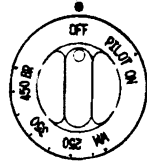

Oven Control Knob in "OFF" position

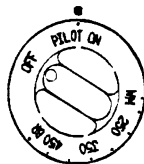

Oven Control Knob in "PILOT ON" position

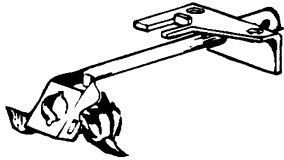

Lighting oven pilot (when pilot is located on left side of burner.)

### To Turn Oven Pilot Off

Press oven knob inward and turn to OFF, past PILOT ON position.

## OPERATING THE OVEN

Press and turn the oven control knob (counter-clockwise) to the desired temperature. The oven will pre-heat in about 10 minutes.

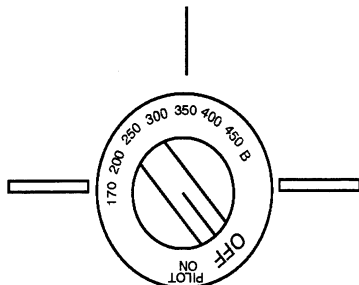

There is a delay of about 30 seconds before the

main burner ignites. This is a normal safety feature and there is no gas escaping during this delay. It is also normal for the oven burner flame to cycle off and on at all temperatures except broil.

### Shut Down Instructions

When oven cooking is finished, turn the oven control knob to the "PILOT ON" position, the oven standby pilot will remain lit.

When the recreational vehicle is not in use or while traveling, turn the oven control knob to "OFF" position and turn off main gas supply; this will turn off the oven pilot.

### Further Information

See the Wedgewood Range/Oven manufacturer's information in your motor home operations manual binder for more precautions and operating instructions.

## MICROWAVE OVEN (Optional)

For complete operating instructions, refer to the manufacturer's information provided with the oven.

## DISHWASHER (Optional)

For complete operating instructions, see the manufacturer's information provided in your motor home operations manual binder.

## WASHER-DRYER (Optional)

For complete operating instructions, see the manufacturer's information provided in your motor home operations manual binder.

## RANGE HOOD

The range hood vent is built into the underside of the microwave oven. The range hood fan draws cooking odors and gas fumes through a filtering system and recirculates the air. A light on the underside of the hood provides better illumination for food preparation. The hood fan and light switches are located on the microwave control panel.

### To Clean Grease Filter or Replace Light Bulb

The grease filter and the hood light cover glass are held in place by a spring clip. To remove for cleaning, hold the filter or glass up with one hand

and squeeze tabs of the clip together with the other hand.

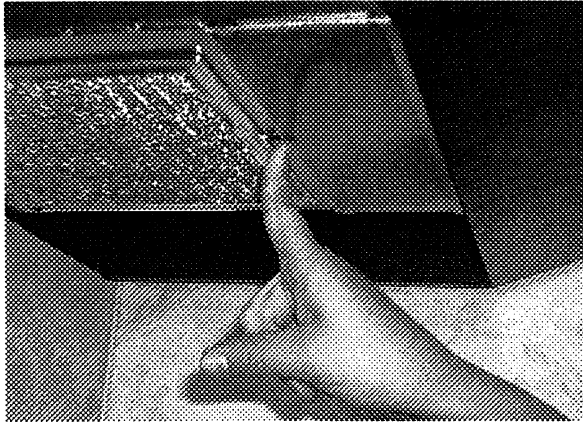

## MONITOR PANEL

The monitor panel is located on the wall near the range hood. It provides central location of switches for the water pump and tank level indicator lights.

The auxiliary electric generator start/stop switch and hourmeter are also located on the range hood panel. See Section 6 for generator starting and stopping instructions and operating precautions.

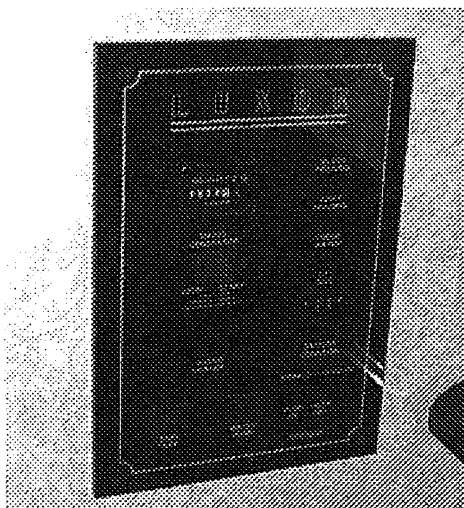

Monitor Panel

## Generator Start/Stop Switch

See Section 6, Electrical Systems for generator start-up and shut-down instructions.

## Generator Hourmeter

See Section 6, Electrical Systems for generator hourmeter information.

## Water and Holding Tank Levels

Press and hold the “Levels Test” switch to show approximate level on the monitor lights.

The approximate water levels are measured by sets of electronic probes in the sides of the tanks, so the water must be touching a probe to register at that level. There is generally more water in a tank than indicated on the monitor panel.

For example, a water level of 1-2” below the FULL probe, the monitor will show the level to be only 2/3 even though the tank is nearly full. If the water level is below the 1/3 probe, the monitor will register an empty tank because the water is no longer touching the 1/3 probe. There may actually be some water left in the tank. However, when the indicator reads FULL, the tank is actually full.

## Tank Capacities

See back of “To The Owner” page inside front cover of this manual.

## LP Gas Level

Press and hold the “Levels Test” switch to show approximate LP tank level.

The LP level is registered by a sending unit on the tank. The gauge mounted on the side of the tank will give a more accurate indication of actual tank level if needed.

## Water Pump Switch

When you want to use the self-contained water system, turn on the “Water Pump” switch on the monitor panel. The “Pump On” light will illuminate when the pump switch is turned on. Water will be available as soon as a faucet is opened.

For your convenience, additional switches are located in the bathroom and in the exterior shower compartment.

## Battery Condition Meter

Push the “Levels Test” button to check the level of charge (voltage) in the 12-volt coach battery. The indicator segments will light from the bottom up to the amount of charge the battery contains.

To get an accurate reading;

1. Both the chassis engine and the auxiliary generator engine must be shut off.
2. An interior light should be turned on to provide a small load which draws off the battery surface charge.

## WATER HEATER

Direct Ignition Model GH6-6E

1. Place Water Heater switch in the "On" position. The switch and "Pilot Out" light are located on the range hood or monitor panel.
2. If "Pilot Out" light stays on longer than 15 seconds, place switch in "Off" position and wait 5 minutes.
3. Repeat step one.
4. If heater fails to operate due to high water temperature, the heater will go into a lockout condition ("Pilot Out" light on). When water cools, reset by placing switch in "Off" position for at least 30 seconds, then return to "On" position.
5. If a lockout condition persists: contact your dealer, an Atwood Service Station or Atwood Service Department (Phone: 815-877-5700).
6. For complete shut-down before servicing:
  - a. Place Water Heater switch in the "Off" position.
  - b. Remove red wire from left-hand terminal of ECO switch (ECO to valve).

### Water Heater Switch and "Pilot Out" Indicator

Be sure the water heater is filled with water before pressing this switch. To fill the water heater, turn the water pump switch on and open a hot water faucet until water begins to flow.

The "Pilot Out" light will glow for about 10-15 seconds after the water heater switch is turned on, then it will go off.

If the "Pilot Out" light comes on during normal operation, it means that the burner has gone into "lockout" mode. Turn the switch off for about 5 minutes, then turn back on.

**Water Heater Capacity: 6 gal.**

### Pressure-Temperature Relief Valve

On occasion, water may be seen seeping from the water heater pressure temperature relief valve. This is no cause for repair or replacement of the valve.

P-T Valve  
(Lift Straight Out Slowly -  
Let Snap Back)

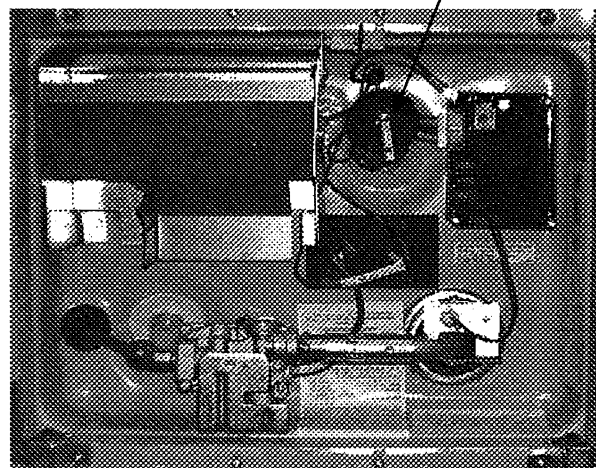

Water Heater - Exterior Service View

Normally there is an air gap at the top of the water heater tank which acts as a pressure buffer. In time, however, heated water may expand and fill this air gap, causing a slight increase in water pressure. This may cause the P-T valve to "weep" until the air gap is manually replaced.

**OPERATE THIS VALVE ONLY WHEN THE WATER HEATER AND COOLING SYSTEM ARE COLD!**

To Replace the Air Gap:

1. Turn off the water heater switch and incoming water supply (city water and/or demand pump).
2. Open a faucet in the motor home to relieve water pressure.
3. Pull the handle of the P-T valve straight out and allow water to flow until it stops.

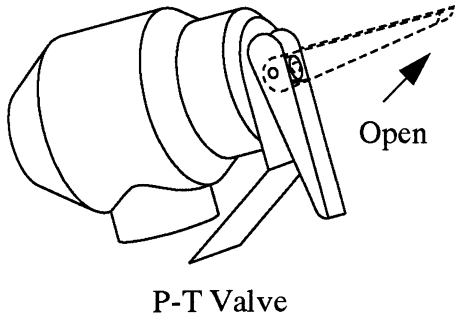

P-T Valve

4. Let the handle of the P-T valve snap shut.
5. Close the faucet and turn on the water supply before switching the water heater on.

Manually operate the pressure temperature relief valve at least once a year.

### WATER HEATER BY-PASS VALVE

Your coach is equipped with a water heater by-pass valve for easier winterization of water lines using RV antifreeze. The valve is located behind the access panel on the side of the refrigerator cabinet toward the front of the coach.

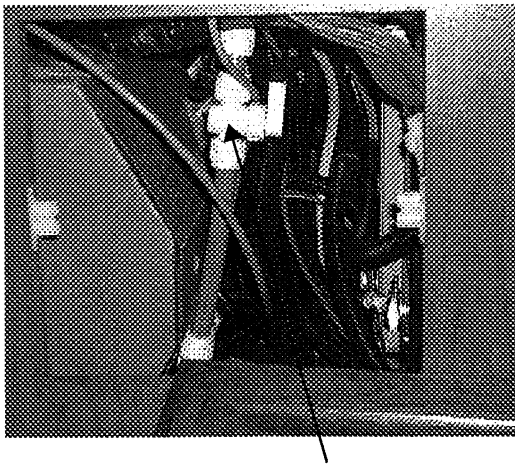

Water Heater By-Pass Valve

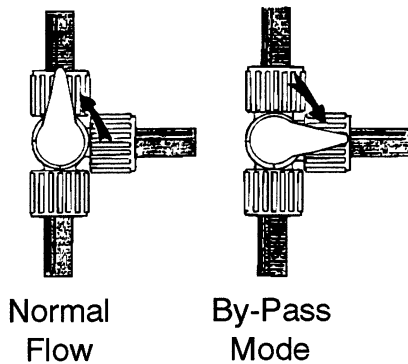

**CAUTION**  
Leave by-pass valve handle in **NORMAL FLOW** position if draining water and blowing out water lines. Place in **BYPASS** position **ONLY** when using antifreeze solution in water lines.

### MOTOR AID WATER HEATER

The motor aid uses heat from the chassis engine cooling system to heat water in the water heater while driving. Hoses are routed from the engine to a heat exchanger surrounding the water heater tank.

Under normal conditions, the entire contents of the water heater can be heated to about 140°F in about two hours or 100 miles of driving. This means you can have hot water at the faucets immediately upon arriving at a site, or even while driving if needed.

The motor aid also increases the capacity of the engine cooling system, allowing the engine to run cooler under many conditions.

**CAUTION**  
Any leak in the heat exchanger or its supply or return lines could cause loss of coolant and subsequent engine failure. We recommend that you periodically inspect these connecting lines and the heater to insure that no leaks have developed.

### Motor Aid Water Heater Maintenance

Have your authorized dealer check all hose clamp connections on the motor aid water heater at least every six months and tighten them if necessary.

### LP GAS FURNACE (SUBURBAN)

#### To Start Up:

1. Close the LP gas tank valve.
2. Turn thermostat/system switch on. (Refer to Electronic Thermostat instructions.)

3. Set thermostat above room temperature to begin blower operation. A slight delay will occur before the blower comes on. Allow blower to run for 5 minutes for combustion chamber purge cycle.
4. After 5 minutes, set thermostat lever below room temperature. Blower will remain on. Wait approximately 2 minutes for blower to go off.
5. Open LP gas tank valve.
6. Set thermostat to desired temperature. If set above room temperature, blower will come on.
7. Allow 30 seconds for main burner to light after blower comes on. This furnace is equipped with an ignition device which automatically lights the burner. Do not try to light the burner by hand.
8. If burner does not light, repeat Steps 1 through 5. (If heat does not come out of the heat duct after a minute or so, the burner is not lit.)
9. If after three (3) attempts with no ignition, go to shut-down and contact your dealer or a local recreational vehicle service center. Do not continue to cycle furnace through thermostat in an attempt to get ignition.

*NOTE: For normal operation after initial start-up, be sure the thermostat switch is in HEAT position, then place the temperature selector to the desired temperature. The furnace will start and cycle on and off automatically.*

### To Shut Down:

1. Slide thermostat/system switch OFF.
2. Close LP tank valve.

### For Further Information

Please see the Suburban furnace operating instructions provided in your Owner Information binder for further information, including operating precautions, and periodic maintenance.

## ELECTRONIC THERMOSTAT

### (Central Heat/Air Conditioning System Only)

The thermostat, located in the galley area, controls heating, air conditioning and cooling fan

features.

Heating/Cooling Thermostat      Power Ventilator Thermostat

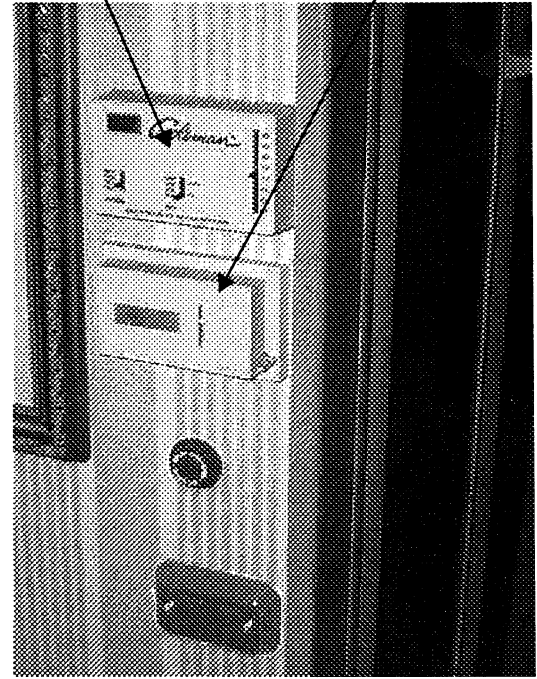

*NOTE: The thermostat does not automatically switch between heating and cooling. You must place the switch in the desired position.*

### Heating:

- Slide the system switch up to “Heat” position.

*NOTE: Follow proper furnace lighting procedures described previously in this section.*

- Adjust the temperature setpoint to personal preference if needed. See “Changing Temperature Setpoints.”

### Cooling (A/C):

- Slide the system switch up to Cool position.
- Slide the Cooling Fan Switch to the desired position.

**On/Low:** A/C compressor cycles on and off with the thermostat while fan runs continuously at low speed.

**On/High:** A/C compressor cycles on and off with the thermostat while fan runs continuously at high speed.

**Auto/Low:** Fan runs at low speed and cycles on and off with the A/C compressor as controlled by the thermostat.

**Auto/High:** Fan runs at high speed and cycles on and off with the A/C compressor as controlled by the thermostat.

- Adjust the temperature setpoint to personal preference if needed. See “Changing Temperature Setpoints”.

**Fan:**

- Slide the system switch down to “Fan” position. The fan will run continuously at high speed and is not controlled by thermostat setting. The display will show current room temperature.

**Changing Temperature Setpoints:**

The thermostat is pre-set to 68° F for heating and 78° F for cooling. You can change these settings up or down to your liking using the MODE switch.

- Press the Mode switch until the small arrowhead on the display appears next to the word Heat or Cool.
- Press either the UP or DOWN button until the display shows the temperature you want.
- Press the MODE button until the arrow appears next to “Actual”. The display will indicate current room temperature. Your setpoint change is now locked in until the next time power is disconnected for longer than 2 minutes.

**Time Delay**

A time-delay feature of this thermostat protects the air conditioner compressors from damage by power cycling on and off such as during brief power outages.

**Power Outages or Disconnections**

The thermostat stores two minutes of back-up power to keep the electronic circuitry energized during short power outages or while switching from the generator to shoreline power

or vice versa. If power is off for more than two minutes, the thermostat will revert to its preset temperature setpoints and must be reset according to personal needs.

**Further Information**

See the Coleman thermostat information sheet supplied in your motor home operations manual binder. This information provides detailed descriptions and operating information.

**CENTRAL AIR CONDITIONER**

*NOTE: See “Electronic Thermostat” for instructions on turning the air conditioner on and changing the thermostat settings.*

The central air conditioner is mounted in an exterior compartment on the left (driver) side of the coach. (See page 0-4.) The compartment door opens for easy maintenance and periodic service. (See “Condenser Coils”) The cooled air is forced through ducts in the ceiling of the coach. Inside air returns to the air conditioner through a filter system beneath the couch in the living room area of the coach. (See “Air Conditioner Filters” below.)

**AIR CONDITIONER FILTER**

The disposable furnace type filter is located in the coach floor beneath the rearward end of the sofa. The filter must be inspected and replaced periodically so the air conditioner can operate efficiently.

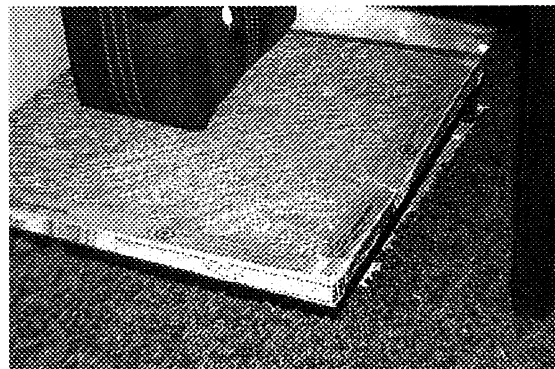

Air Conditioner Filter  
(beneath couch and galley)  
Open couch face/drawer to access



### To Replace the A/C Filter:

- Pull the couch storage drawer/face outward. (Push one end of the hidden handle and rotate to expose handle.)
- Lift the end of the filter and pull to the right to clear the retainer strip on the left end.
- Insert left end of new filter under retainer strip and lay filter flat over air return opening.

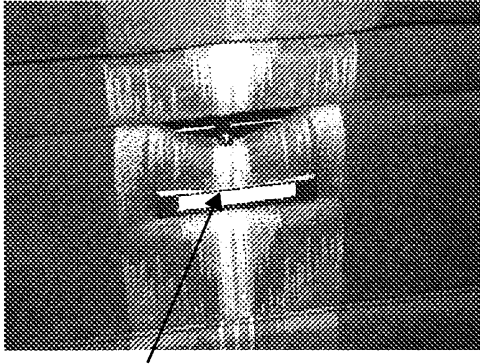

Press one side of hidden hand and rotate to access. Pull sofa drawer outward.

### A/C Filter Size: 14" x 20" x 1"

*NOTE: Do not block the filter in any way, such as by setting packages or newspapers, etc., on top of it. There must be free air flow for the air conditioner to operate efficiently.*

### Condenser Coils

The condenser is located in a compartment on the left side of the coach. The condenser is the large, silver, rectangular area that looks like a car radiator.

Periodically sweep debris carefully from the fins of the condenser. Rinse dust off with clean water. The condenser coils must be clean and free of dust, debris and insect particles, etc., for the air conditioner to cool efficiently.

### Further Information

See the air conditioner manufacturer's operating instructions supplied in your Motor Home Operations Manual binder. They contain detailed operating instructions, special precautions and basic troubleshooting.

See "Electronic Thermostat" for start-up and thermostat setting instructions.

### TV ANTENNA - Optional

The TV antenna on your motor home can be easily raised, rotated a full 360° and lowered from inside the vehicle by simply turning a crank or rotating knob. A built-in signal amplifier designed to strengthen signals, is controlled by a power switch built into the TV jack assembly.

The signal amplifier is housed inside the antenna with the circuit board connected directly to the antenna elements. Power to operate the amplifier (12-volt DC) is supplied through the download cable which also carries the TV signals to the TV set. The power supply separates the 12-volt DC from the TV signals and provides a place for attaching the TV set and the 12-volt power source.

### Operation

**Raising Antenna** - Turn elevating crank clockwise in "UP" direction about 13 turns or until some resistance to turning is noted. Antenna is now in operating position. Turn amplifier power switch "ON" to receive TV signal.



**WARNING**  
Never allow the antenna to touch electrical power lines or any other electrical wires.

**Rotating Antenna** - Make sure antenna is in the "UP" position. Pull down on rotating knob until it disengages ceiling plate and rotate for best picture and sound on TV set.



**Lowering Antenna to Travel Position** - Rotate antenna until pointer on rotating knob aligns with pointer on ceiling plate.

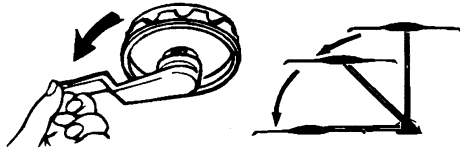

**CAUTION**  
Never leave the antenna partially raised or partially lowered. This can damage the crank mechanism gears. Always raise the antenna straight up or lower it completely into the travel position.

Turn elevating crank (counterclockwise) in “DOWN” direction until resistance is noted. Antenna is now locked in travel position. Turn amplifier power switch “OFF”.

Count the number of turns needed to crank the antenna down to the roof of the unit (normally about 13). Mark the final position of the crank handle on the ceiling or the directional knob for reference. Also mark the number of turns needed. Use the mark and number as a reference whenever you lower the antenna.

**CAUTION**  
Always align directional handle to “DOWN” position before lowering.

### ANTENNA SIGNAL AMPLIFIER

To operate amplifier, turn on power switch.

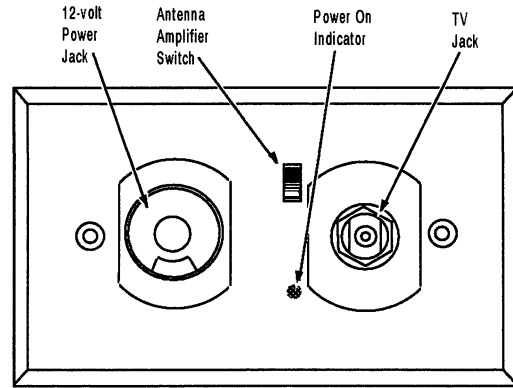

The TV jack plates are mounted in various locations throughout the coach. Some of these wall plates are not readily visible and may be in one of the following locations.

- In front overhead cabinet.
- In the optional entertainment center on the outside of the coach.
- Behind the optional rear bedroom TV.

### Checking Amplifier Performance

The TV signals available to an RV are entirely dependent on its location in relation to the transmitter. Signals may vary from strong to no usable signal at all. We recommend that the TV system be checked out in an area known to have good TV reception.

To check the antenna amplifier, raise the antenna, select a TV channel and rotate the antenna for best picture. Then turn off the amplifier power switch. If the antenna amplifier is working properly, the TV picture will now be degraded (snowy). When you turn the switch back on, the picture should again be sharp.

### DSS™ SATELLITE TELEVISION SYSTEM - Optional

The DSS Satellite Television System allows you to receive TV programs directly from satellite to your coach. The programs are transmitted in digital format so the quality is equal to laser disc or CD.

See your **Winegard RV Digital Satellite Antenna System Owner's Manual** for instructions about aiming the satellite antenna dish. There is a supplemental Quick Reference Guide for the DSS system with RCA Receiver. The

coach must be level before attempting to aim the antenna dish.

See your **RCA Satellite Receiver User's Manual** for instructions about setting up the receiver and remote unit. *NOTE: See the Glossary on pg. 48 before beginning. It will help your understand many technical terms.*

We recommend that you **read** both of these manuals **thoroughly** to understand the system completely before attempting any setups or adjustments.

**DSS with Optional Video Control Center:**  
Press the AUX switch to connect the TV to the DSS system. The satellite system is hooked through the AUX input of the video control center.

**DSS without Optional Video Control Center:**  
Turn off the power switch for the TV Antenna Signal Amplifier to route the DSS system signal to the TV input jacks.

## VIDEO CONTROL CENTER - Optional

The optional video control center allows you to switch the antenna, cable TV or VCR signal to any TV set location in the coach.

This means one person can watch a ball game coming in on the roof antenna on the bedroom TV while another person watches a cable TV program or a video tape on the VCR on the front TV. Also, two people can watch different programs on the two TV's while taping a third program on the VCR.

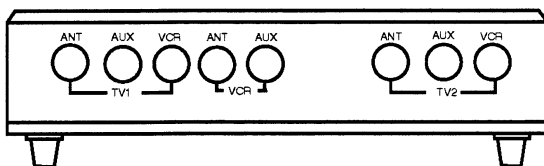

### Components

TV1 = Front TV

TV2 = Bedroom TV

VCR = Videocassette Recorder

### Signal Inputs:

**ANT** - Press to connect selected TV or VCR to the roof antenna.

**AUX** - Press to connect selected TV or VCR to cable TV input.

**VCR** - Press to connect selected TV to the videocassette recorder/player.

## DC-AC ELECTRICAL VOLTAGE

### INVERTER - Optional

The voltage inverter changes 12 volt DC current into 110 volt AC current to operate your TV and VCR while traveling or when shoreline hookup is not available.

- The inverter must be switched on to operate.
- Turn the inverter off when not in use to avoid draining the coach or automotive batteries.

*NOTE: This information does not apply to the 2000 watt inverter/charge option. For that model, see Electrical section page 6-3.*

## EXTERIOR ENTERTAINMENT CENTER

The exterior entertainment center contains a stereo radio/cassette player and convenient TV hook-ups for your outside listening or viewing pleasure.



## CABLE TV AND PHONE HOOK-UPS (Input)

The cable television and telephone input connectors are located at the left hand side of the utility service compartment.

The cable and phone lines can be routed through the hatch in the bottom of the compart-

ment so the door can remain shut while connected.

*NOTE: For coaches without the video control center option, be sure the TV antenna amplifier switch is turned OFF while connected to cable. The antenna amplifier will make the cable TV signal snowy.*

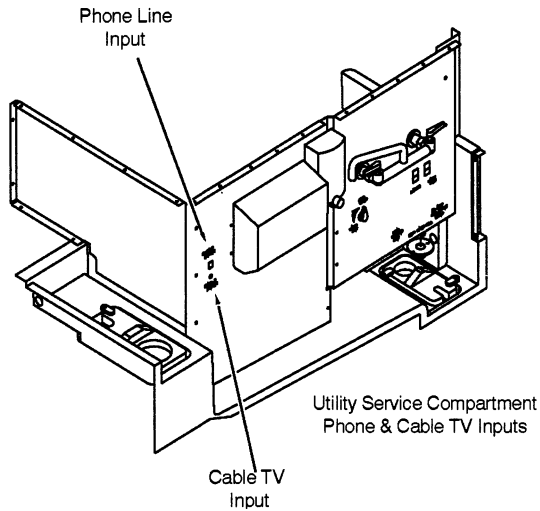

### Phone Jack Locations

There are two phone jacks in your coach for you to plug phones into; one in the front and one in the rear:

**Front:** In living room area, on wall beneath pull-out lounge table.

**Rear:** In bedroom, on left (driver side) corner cabinet, near bedroom radio.

### CENTRAL VACUUM CLEANER

The central vacuum cleaner system is located beneath the "floor" of the wardrobe cabinet.

**To Use The Vacuum:** Plug the hose into the hose outlet. The vacuum cleaner will start automatically. When you remove the hose, the vacuum will stop.

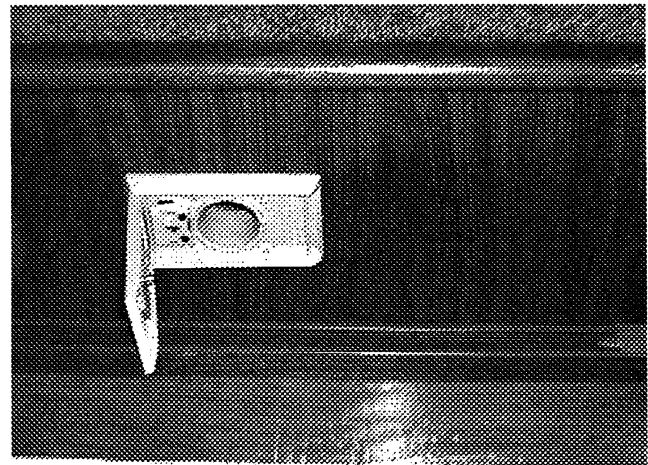

**To Change Filter Bags:** Remove the floor of the wardrobe and pull the cover from the square metal canister.

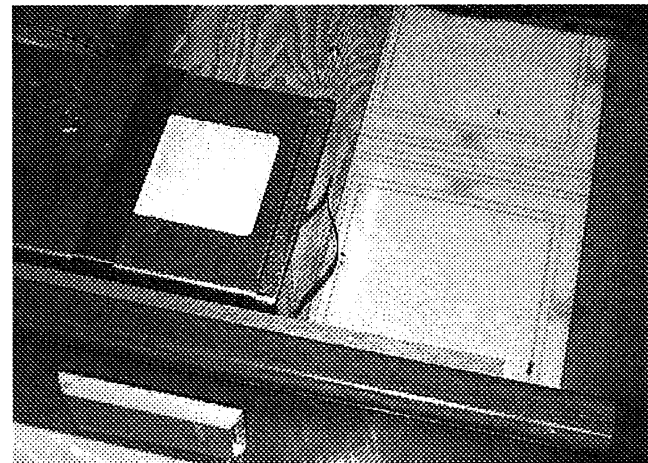

**If The Vacuum Will Not Start:** Check for a tripped circuit breaker. Also be sure that the vacuum unit is plugged into the electrical outlet.

### AUDIOVOX BEDROOM RADIO

The bedroom is equipped with a built-in stereo radio system in the left rear nightstand cabinet. This radio features AM/FM stereo radio with electronic seek/scan tuning, auto reverse cassette player/recorder with music search, and a full featured alarm clock mode.

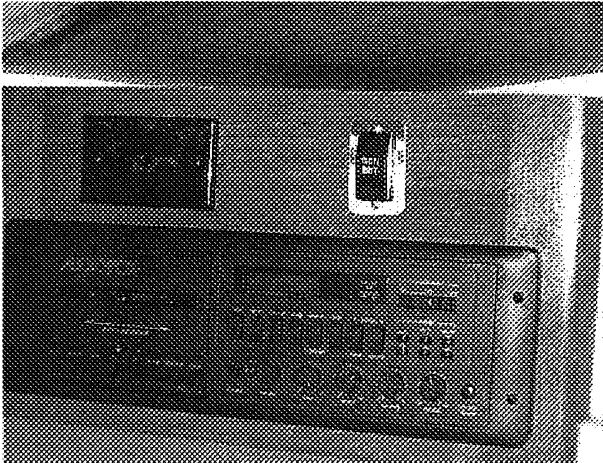

See the Audiovox operator guide on your Operations Manual binder for full operating instructions by the manufacturer.

(See also Safety Precautions, Section 1 of this manual.)

## SLEEPING FACILITIES

**WARNING**  
Do not use sleeping facilities while vehicle is moving.

### COUCH-BED CONVERSION

#### To Convert Sofa to Bed:

- Push the sofa latch to the right while pulling the front edge of the sofa seat upward and outward from the wall and pushing downward on the backrest until the cushions lie flat. The bed is now ready for use.

Push latch to the right.  
Lift seat upward.

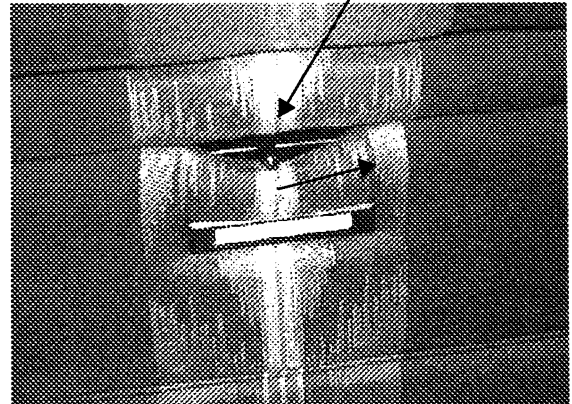

#### To Revert Back to Sofa:

- Push the front edge of the sofa seat toward the wall while lifting upward on the backrest until the sofa is fully seated against the wall.
- Reposition ottoman and fasten onto sofa.
- Push front edge of sofa seat down to be sure latch engages.

## FRESH WATER TOILET

The fresh water toilet in your motor home is very similar to the household type, except that it is designed to use only a small amount of water per flush. It uses a high velocity jet of water, producing a swirl effect, to efficiently cleanse the bowl. And since each flush uses fresh water, no special chemicals are required other than a deodorizing agent, if necessary.

1. To add water to the toilet before using, lift the flush lever until the desired water level is reached. Generally, more water is required only when flushing solids.

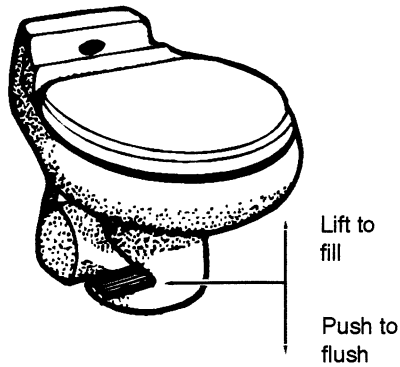

2. To flush the toilet, push the lever all the way down until sewage leaves the toilet and bowl is rinsed clean.
3. Release the flush lever. A small amount of water should remain in the bowl.

Please refer to the manufacturer's information supplied with the toilet for further operating and maintenance instructions.

#### Important "Don'ts"

- Don't use facial tissue or regular toilet tissue in the RV toilet. These will not disintegrate sufficiently and will often cling to the sides of the holding tank. Toilet tissue made specifically for use in RV toilets and holding tanks is available at most RV supply centers.
- Don't dispose of sanitary napkins or other non-dissolving items in the toilet.
- Don't put automotive antifreeze or caustic chemicals, such as laundry bleach or heavy detergents into the toilet or holding tank. These products may damage plastic or rubber parts in the system.

#### Cleaning the Toilet

The toilet should be cleaned regularly for maximum sanitation and operating efficiency. If an odor is apparent from the toilet:

1. Clean the toilet bowl with a mild bathroom cleaner. Do not allow cleaners to set in the bowl for long periods of time to avoid damaging the seals. Do not use caustic or abra-

- sive cleaners in the Thetford toilet since it may damage the plastic surfaces.
2. Dump and rinse holding tank.
3. Add odor control chemical in amount specified after cleaning and every few days during use.
4. Remove the water line from the base of the toilet and clean the screen.
5. If the flush valve becomes stiff after extended use, it may be lubricated with a silicone spray. Turn the water pump off and operate flush pedal to drain water from the toilet bowl. Spray silicone lubricant onto flush valve inside bowl and operate flush pedal a few times to ensure free operation.

See instructions in Section 10 to prepare the toilet for storage in freezing conditions.

#### POWER ROOF VENT - Bath Area

The power vent in the bathroom ceiling is controlled by switches on the bathroom wall. The VENT switch raises (open) or lowers (close) the powered dome. The FAN switch controls the single speed exhaust fan.

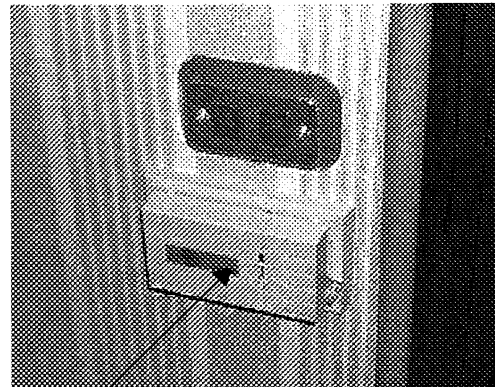

Bath Power Vent  
Thermostat

#### POWER ROOF VENT - Galley Area

The power roof vent in the galley ceiling has a 3-speed turbine fan and a power dome. The vent is controlled by a thermostat on the galley wall, which will automatically raise the dome and turn the fan on when the temperature reaches the setting you have chosen. When the air around the thermostat has cooled to below

the setting, the dome will automatically lower and the fan will shut off.

The thermostat control can be placed in the OFF position to cancel power to the power dome and vent fan.

## SLIDER WINDOWS

Swing the latch handle straight out from the window. Grasp the sliding window edge frame and slide the window to the side. Be sure the latch is open before trying to slide the window closed.

Power Ventilator  
Thermostat

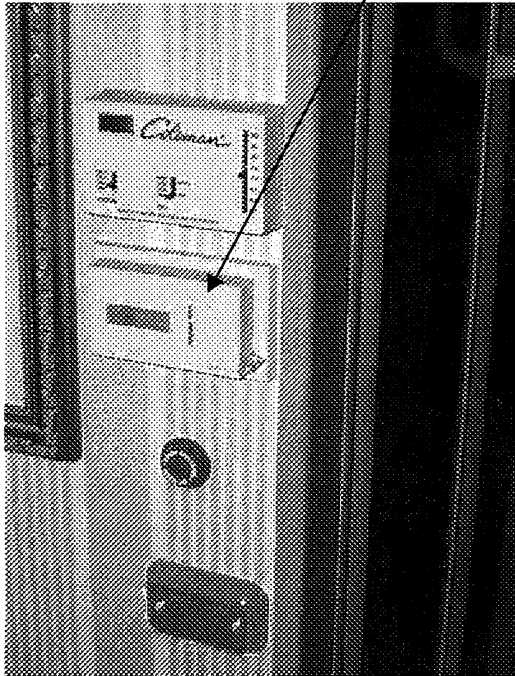

The fan shroud on the ceiling has a fan power switch that lets you turn the fan off if you want just the vent dome raised with no fan running. The fan speed switch allows you to adjust the amount of circulation you need at any time.

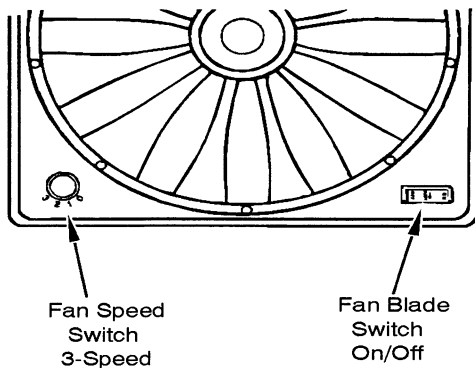





**CAUTION**

Sealants must be inspected every 6 months and resealed if necessary.

### ROOF

The roof is made of Thermo-Panel materials like the walls and floor. It will support the weight of an average adult should it become necessary to repair the roof or roof mounted components. It is not recommended, however, that very large or heavy objects be carried on the roof while the vehicle is in motion. (See page 4-2 for roof loading specifications.) Always have damage to the roof area repaired immediately. Damaged or detached sealant around the vents, air conditioner, body-to-roof seams, etc., should also receive immediate attention. Delaying these repairs may allow water leakage and result in damage to interior ceiling and body panels, upholstery, etc.

### UNDERBODY

Buildup of mud and dirt under the body can cause damaging rust on steel parts and can add needless weight to the vehicle. This, in effect, reduces the amount of cargo you can carry and remain with GVWR and GAWR limits.

Corrosive materials, such as those used for ice and snow removal and dust control, also accumulate on the underside of a vehicle. These materials should be removed by flushing the underbody regularly with water, especially areas where mud and other foreign materials collect.

### EXTERIOR

The exterior surface of your motor home has an automotive finish. Frequent washing and thorough cleaning is recommended to prevent damage to the vehicle finish after exposure to damaging salts, calcium chloride, road tar, tree sap, insects and other foreign material. Never wash the vehicle in direct sunlight, while the vehicle surface is hot, or using hot water.

Do not use strong soaps or detergents for washing the motor home. Always use a mild soap in warm water, a commercially prepared product for cleaning automotive finishes or your local car wash. Be careful when using pressure-type washers to avoid loosening exterior decals or sealants, etc.

After washing the motor home, carefully inspect caulking around window frames and vents and any other joints that may have separated. Re-caulking, if necessary, is quite simple. Appropriate compounds are sold at Winnebago and Itasca dealers, and the materials are quickly and easily applied. Also, inspect weather seals around door, etc., and if necessary have a dealer replace them immediately.

**CAUTION**

Never use a strong solvent such as lacquer thinner, or harsh abrasives on painted surfaces.

It is recommended that a coat of automotive wax be applied to the surface occasionally to provide added protection against harmful deposits coming in contact with the paint.

### COMPARTMENT DOORS

Apply powdered graphite lubricant to compartment door latches periodically as necessary to keep latches operating smoothly.

If rubber door seals should become sticky, making the door hard to open, apply a rubber protectant such as 303™, Armour-All™, Son-of-a-Gun™, etc..

### CARE OF STRIPES AND DECALS

The pressure-sensitive decals on your coach require very little maintenance. They should be treated like any painted surface on your vehicle. Here are a few helpful hints on caring for decals:

- Wash decals with plain soap and water or any retail car wash soap. Always rinse thoroughly.
- Keep high-pressure wash nozzles at least 1 1/2 feet from edge of decals. High pressure water spray may cause edge lifting of decals.
- Test any cleaning solution on a small section of decal before using.
- Do Not use any aromatic solvents such as acetone, MEK, toluene, xylene, etc., on decals. Any solvent including alcohol may soften or smear colors.
- Do Not use lacquer thinner or paint on decals. Do Not overcoat decals with clear paint.
- Do Not let gasoline or other fuels drip and stay on decals for any length of time. Rinse immediately.

*excessive sunlight, the drapes, blinds or shades should be closed when the motor home is parked for an extended period of time.*

**WARNING**

When cleaning upholstery and fabric, do not use lacquer thinner, nail polish remover, laundry soaps, or bleach. Never use carbon tetrachloride, gasoline, or naphtha for any cleaning purpose. These materials may cause damage to the material being cleaned and most are highly flammable.

**UPHOLSTERY, CARPETING AND DRAPERIES**

We recommend a weekly routine of vacuuming all fabrics and carpet throughout the motor home to prevent an accumulation of dirt which can detract from the appearance and shorten the life of carpet and fabrics.

**Carpets**

See the carpet manufacturer's Carpet Care Guide in your Motor Home Operations manual binder. It includes detailed information on cleaning soils and removing stains from the fine carpet in your coach.

**Upholstery**

Some fabrics used in this motor home may contain fire retardant and lightfastness additives which can be damaged by use of improper cleaning products. Some water-based household cleaning products are not formulated for use on fabrics and may cause excessive shrinkage or fading. Always test any cleaning product on a hidden area of fabric before using on visible areas. For best results, fabric cleaning should be referred to a professional carpet and upholstery cleaner.

*NOTE: To minimize fading of upholstery, carpets and other interior fabrics caused by*

**Spots and Stains**

Spots or stains should be treated as soon as possible before they "set in" to avoid permanent damage. Always start from the outside of a spot or stain and work inward to avoid spreading it. Use a clean cloth or sponge and turn frequently to an unused area of the cloth or sponge as you clean.

Some stains or soils, such as lipstick, ink, grease or mustard, are extremely difficult or impossible to remove completely and should receive immediate attention. Consult a professional carpet and upholstery cleaner for assistance.

**Leather Upholstery - Driver/Co-Pilot Seats (Optional)**

The optional leather seats are made of top quality cattle hide soft leather.

- We recommend using a mild soap and water applied gently to the soiled areas. Buff dry immediately with a soft cloth to avoid water spotting. Avoid harsh and excessive rubbing while cleaning. Soft leather needs delicate care.
- Never use harmful substances (e.g. stain removers, solvents, saddle soap, shoe polish or other unsuitable fluids) on soft leather. Cleaning and touch-up kits specifically formulated for leather upholstery are available from most fine furniture dealers.

## Vinyl Fabrics

Vinyl should be cleaned with a soft, damp cloth, and a mild detergent only. Do not use solvents. Solvents may damage the surface of the vinyl.

## Draperies, Curtains and Bedspreads

These items may be woven from a variety of fabrics. We recommend that these be professionally dry cleaned only. A five percent shrinkage may occur when you have these items dry cleaned.

## CABINETRY

Your cabinets are made of high quality hardwoods. Clean and beautify using a soft cloth and a good quality wood finish cleaning product such as Guardsman™, etc.

*NOTE: Cabinetry and furniture items throughout this motor home are constructed either partially or completely of real hardwoods. Because of natural variations in woodgrain density, slight differences in stain hue may exist between one item and another. This is the distinctive character and beauty of real wood.*

## Decorative Cabinet Mirrors and Windows

Use a good quality glass cleaner or mild soap and water solution. It is best to use a spray bottle to apply a light mist rather than saturating the surface. **WIPE DRY IMMEDIATELY. DO NOT ALLOW GLASS TO REMAIN WETTED FOR LONGER THAN A FEW SECONDS.** Prolonged moisture can cause the applique coating to lift from the surface of the glass.

Do not use sharp objects to scrape debris such as fly specks etc. Sharp objects can chip or lift the applique coating.

## TABLES AND COUNTERTOPS SURFACES

The tables, countertop and work surfaces are made of beautiful and durable solid surface material.

- Wipe clean with a sponge and soapy water or ammonia-based cleaner.
- Stubborn stains may be removed using a 3M Scotch-Brite™ or equivalent type scouring pad.
- Towel dry to eliminate water spotting.
- Disinfect by wiping with 50/50 mixture of water and household bleach. Rinse with clean water.
- See the countertop manufacturer's Care & Maintenance booklet in your operations manual binder for further information.

## VINYL WALLBOARD

Decorative vinyl covered wallboards may be cleaned with a mild soap and water solution. Do not use solvents or abrasive cleaning products.

## STAINLESS STEEL SINK

The stainless steel sink can be cleaned with soap or detergent. Rinse thoroughly with warm water and wipe dry to avoid streaks.

Use a mild abrasive for stubborn stains. Work in the direction of the polish lines. To keep the original finish, polish with a wax cleaner and rub with a dry soft cloth.

### WARNING

Salts, mustard and mayonnaise may cause pitting. If spilled, clean immediately.

## RANGE AND REFRIGERATOR

For care and appearance maintenance of the range and refrigerator, refer to the operation and maintenance manual for each of the individual appliances included in your Motor Home Operation Manual binder.

## BATHROOM

The tub and shower walls in the bathroom should be cleaned with a mild soap and water so-

## SECTION 9 CARE & MAINTENANCE

# L U X O R

lution, or (to obtain maximum luster) use a good quality wax cleaner. Do not use an abrasive cleaner on the shower walls and tub. If the shower has a glass door, it is extremely important that abrasives not be used. Solvents and aromatic spirits that contain a petroleum base or additive should also not be used. These products can cause a reaction with the glass that results in visible deterioration marks. Use only a good quality glass cleaner or mild detergent and water solution with a soft cloth to clean glass surfaces.

The bathroom lavatory is made of solid surface material and should be cleaned with a mild soap and water solution. Abrasive cleaners or harsh detergents should not be used. See "Tables and Countertop Surfaces" for more information.

For instructions on the care of your fresh water toilet, refer to the information in your Motor Home Operation Manual binder.

### DOORS AND WINDOWS

Windows may be periodically cleaned with a good quality glass cleaner or mild soap solution using a soft cloth. Use care when removing ice or frost from the windows. Always use a plastic ice scraper, never one made of metal. Use care when removing ice from the mirrors to protect the reflective surfaces.

Door locks and hinges should be lubricated periodically with powdered graphite to ensure trouble-free operation and to protect against freeze-up.

### VEHICLE MAINTENANCE

(See also Safety Precautions, Section 1 of this manual).

### CHASSIS SERVICE & MAINTENANCE

Consult the appropriate sections in your chassis operating guide for specific information regarding operating safety, service recommendations and maintenance schedules for the chassis section of your motor home.

### ENGINE ACCESS - Chevy or Ford Chassis

### REAR ENGINE GRILLE

The diesel engine is located behind the grille at the back of the vehicle.

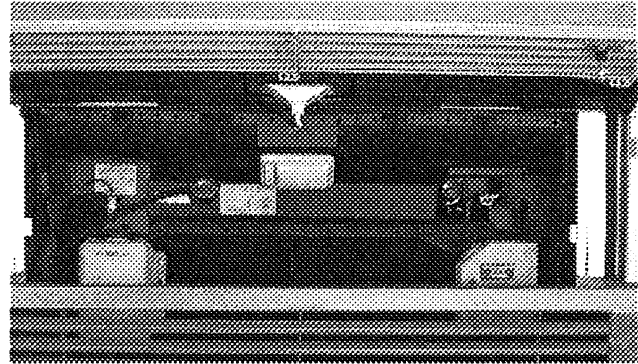

With the service panel open, you can access the following service points:

- Engine Oil Dipstick ("Add" = 2 qts. low)
- Engine Oil Fill Cap
- Power Steering Reservoir
- Radiator Cap
- Engine Coolant Overflow Bottle
- Transmission Dipstick/Fill Tube
- Air Filter Restriction Indicator

Unlock the service panel and swing it upward.

### ENGINE TOP COVER

The engine top cover is located beneath the rear bed. This cover is only removed for replacement of engine parts or if a complete view of the engine is needed for inspection. To do this, remove the mattress from the bed and lift the hinged bed board upward. Support the bed board with a suitable prop rod while accessing engine.

Routine engine inspection can be performed (with protective clothing) under the left rear side of the vehicle, between the luggage compartment and engine exhaust muffler.

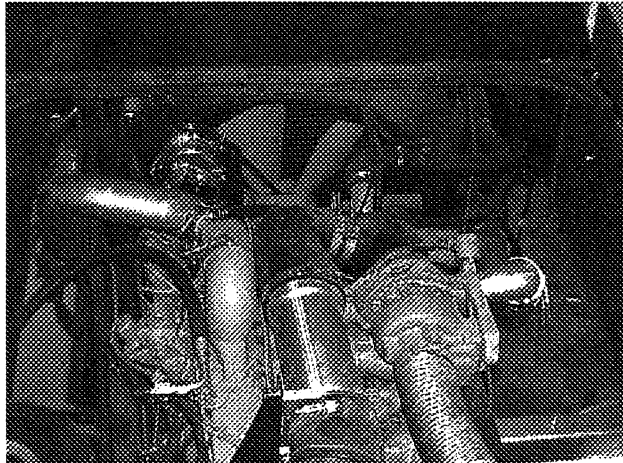

Top View of Engine with Cover Open

## FUEL/WATER SEPARATOR

Diesel fuel often contains small quantities of water which can damage the engine if not filtered out. The fuel/water separator traps this water and prevents it from reaching the engine. The harmful water deposits must be drained from the separator canister during normal periodic service and maintenance to keep the fuel filtration system working effectively.

The fuel/water separator is located in the spare tire/battery compartment behind the rear wheels on the right (passenger) side of the coach. Open the compartment and look towards rear end of the opening.

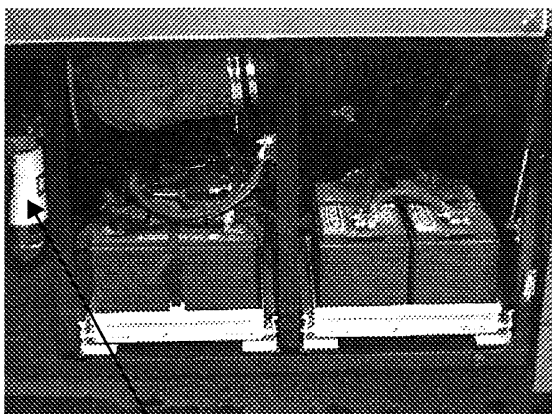

Diesel Fuel/Water Separator

Place an appropriate container beneath the outlet and screw the water release valve open several turns. Drain any water deposits from the canister until clean diesel fuel flows from the valve. Close valve by hand. Do not over tighten.

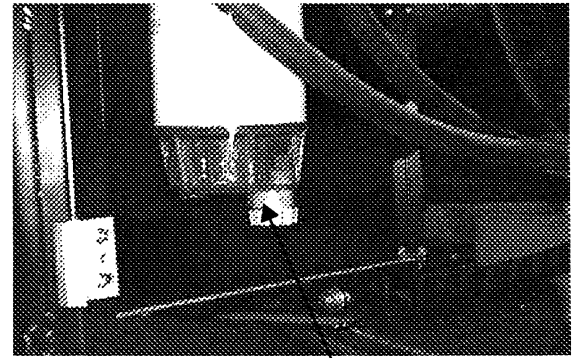

Fuel/Water Drain Valve

Dispose of the drained liquid in an environmentally responsible manner, such as taking to a waste oil disposal center.

## ENGINE COOLING SYSTEM

Refer to your Freightliner chassis operating manual and Cummins engine manual for information and precautions on filling, servicing and checking the fluid level.

### CAUTION

When refilling the coolant system of a vehicle equipped with a rear auxiliary automotive heater and motoraid water heater, be sure to allow for additional coolant capacity of the heater and its supply and return hoses.

## TIRES

Low air pressure results in tire overloading and abnormal wear and also affects handling and fuel economy. Obtain proper inflation pressures from your chassis operating guide or tire manufacturer.

See the Vehicle Certification Label affixed to the rear edge of the driver's door for tire information.

**WARNING**

Make sure all replacement tires are of the same size and ply rating as those installed as original equipment.

**SUSPENSION ALIGNMENT AND TIRE BALANCE**

The front suspension and steering system of this vehicle was factory aligned using highly accurate equipment prior to delivery to the dealership. However, we recommend that alignment be checked and adjusted, if necessary, after you have fully loaded the motor home according to your personal needs. Thereafter, the alignment should be periodically inspected to help prevent uneven tire wear.

Any excessive or abnormal tire wear may indicate worn or misaligned suspension or steering, unbalanced tire or other tire/suspension problem.

Alignment can be affected by worn steering/suspension parts or by incidents which happen during driving, such as hitting a curb, pothole or railroad track, etc. Improper alignment can cause tires to roll at an angle and wear unevenly. It may also cause the vehicle to "pull" to the right or left. Have your dealer inspect your vehicle's suspension and steering components periodically for misalignment or wear.

Out-of-balance tires will not roll smoothly and can lead to annoying vibrations and uneven tread wear such as cupping and flat spots. Tires may need to be balanced if uneven wear is detected or if ride comfort decreases noticeably.

See your chassis operating guide for further information.

**WINDSHIELD WASHERS AND WIPERS**

See your chassis operating guide for recommendations, precautions and replacement information on washers and wipers.

**LIGHTS**

All exterior lights should be checked for proper operation each time the vehicle is prepared for a trip. Any bulbs which fail to light should be checked and replaced, when necessary, with a new bulb of the same size. A failure of more than one light, such as both taillights not operating, may indicate a burned out fuse. Check fuse and replace with one of the same rating when necessary. If a fuse is not the cause of the problem, the wiring system should be checked immediately by an authorized service center.

The headlight circuit is protected by a circuit breaker. An overload on the breaker will cause the lights to flicker on and off. Headlight wiring should be checked immediately anytime this condition is apparent. Refer to your chassis operating guide for further information.

**AUTOMOTIVE 12-VOLT FUSES AND CIRCUIT BREAKERS**

The automotive fuses and breaker are conveniently located on a panel beneath the hinged instrument panel pod. Lift the pod upward as shown.

The circuit breakers will pop outward if they are tripped. Simply push in to reset.

Always replace plug-in type fuses with those of the same amperage size.

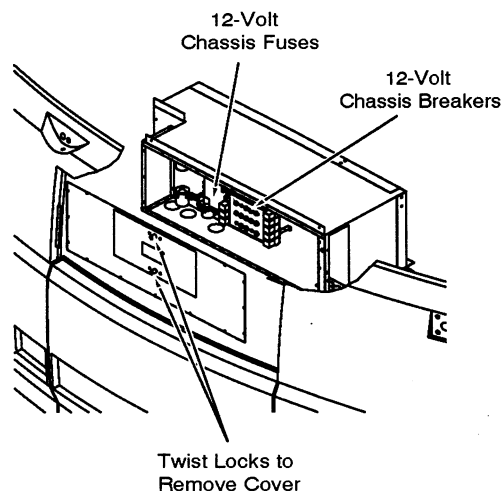

Automotive Fuse/Breaker Panel  
(Behind "Hood" Panel)

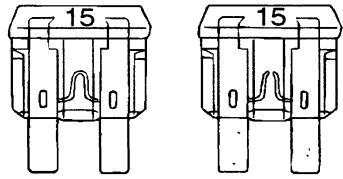

GOOD FUSE    BAD FUSE

PLUG-IN FUSES





### PREPARING VEHICLE FOR STORAGE

Properly preparing your vehicle for storage will lessen the possibility of damage to your vehicle. Prepare the motor home for vacancy just as you would if you were leaving your house for an extended period:

- Remove all perishables from cabinets and refrigerator
- Prop refrigerator door open.
- Turn off LP gas tank.
- Drain water heater, water tank and holding tank.
- Close shades to protect upholstery from sunlight

When storing your vehicle through the winter, or in cold climates, extra preparations need to be made to protect systems that can be damaged by freezing temperatures.

### Cold Weather Storage Procedure (Winterizing)

1. Clean and dump holding tanks by following steps A, B, and C
  - A. Add water to the sewage holding tank by holding the toilet flush lever open with the water pump running. Add water to the waste water holding tanks by opening the kitchen, shower and lavatory faucets. Tanks should be about 1/4 to 1/3 full to rinse properly. Driving to a disposal site will normally loosen and rinse any waste material from the sides of the tank.
  - B. Completely drain the sewage and waste water holding tanks at an approved waste disposal site. Drain the sewage tank first so the following waste water can rinse any waste solids from the dump outlet and sewer hose.
  - C. Close dump valves and refit the dust cap onto the drain outlet.
2. Level the motor home and drain the entire plumbing system as described in the following steps.

3. Open all fresh water drain valves including the shower line valve. (See pages 7-5 and 7-6.)

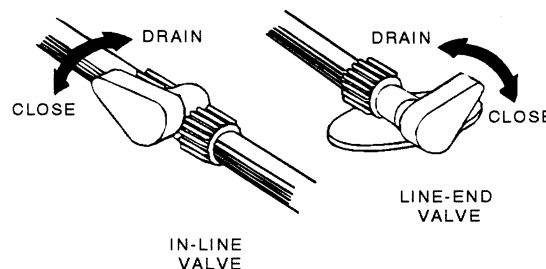

4. Remove and discard the water filter cartridge
  - Raise the valve handle and turn the colored retaining ring fully clockwise.
  - Twist the filter cartridge counterclockwise about 90° and pull it down and out of the filter head.
  - Place a container beneath the filter head and lower the valve handle to drain any water remaining in the filter lines.

*NOTE: If your coach is equipped with the refrigerator ice maker option, the ice maker water lines must also be drained. See "Winterizing the Ice Maker" on page 8-4.*

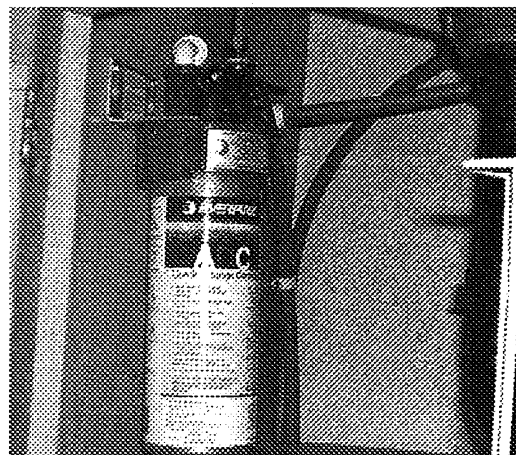

Water Filter Assembly -  
Below Galley Sink

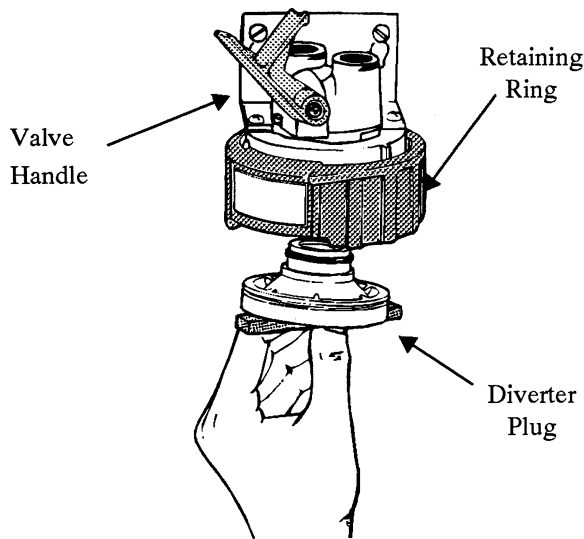

5. Install the antifreeze diverter plug -
  - Raise the valve handle and turn the colored retaining ring fully clockwise.
  - Hold the diverter by the support bar as shown and guide it up into the filter head with bar end approximately centered inside the retaining ring.
  - Push the diverter up into the head as far as possible and turn it clockwise approximately 90°.
  - Then turn retaining ring fully counter-clockwise. The diverter should be locked in position between the head and retaining ring.
  - Lower valve handle to lock retaining ring in place.

*NOTE: Before using again the following spring:*

- *Flush out the system with the diverter in place.*
- *After the system has been thoroughly flushed, remove the diverter and store for future use. The diverter plug is intended for winterization only.*
- *Install a new water filter cartridge.*
- *If your coach is equipped with the refrigerator ice maker option, the ice maker water lines must also be drained. See "Winterizing the Ice Maker" on page 8-4.*

6. Turn the Water Pump switch ON to allow it to operate until you are done draining all faucets and toilet.
7. Open all faucets and shower head valves, including exterior shower.
8. Operate the toilet flush lever and hold until water stops flowing in the toilet. Then turn water pump switch OFF.
9. Turn off the water heater power switch before draining the water heater tank to avoid damage to the heating element. Drain the water heater by removing the plug from the base of the water heater tank, accessible from the outside of the coach. (Requires socket and ratchet.) Also open the Pressure-Temperature relief valve at the top right portion of the tank to prevent air locking in the tank while draining.

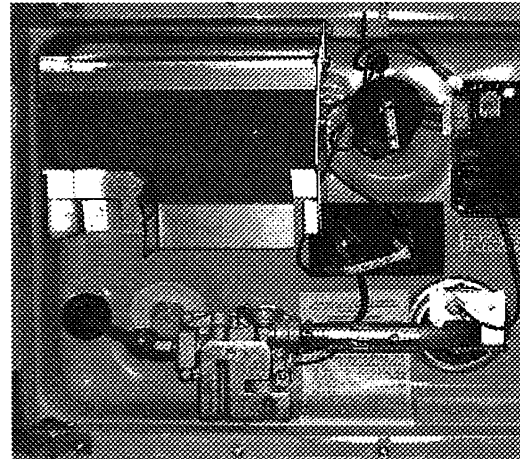

Water Heater Drain Plug  
(Remove with Wrench)

10. After water has stopped draining at all faucets and drain valves, connect a "blow-out" plug to the city water connection on the coach. Then use a hand pump or air compressor regulated to 30 psi or less to force air through the system. (A "blow-out" plug can be purchased at any Winnebago or Itasca dealer. P/N 701705-01-000.)

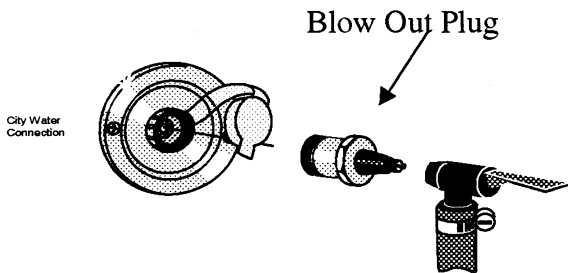

**CAUTION**  
Limit air pressure to 30 psi to avoid damage to pump or water lines.

**NOTE:** *DO NOT burst air into the system. This can damage the water pump. It is better to let air in slowly.*

11. Let air flow for five minutes until water is completely drained out of faucets and drain valves. Then close faucets one at a time.
12. Operate and hold toilet flush lever until water is completely drained from toilet.

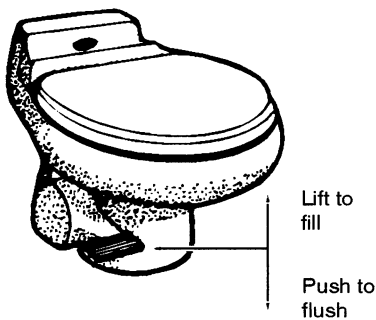

13. Now turn air pressure off and disconnect water purge adapters. Recap the city water connection to avoid contamination by dirt or insects.
14. Close all drain valves and faucets to avoid contamination by dirt or insects. Reinstall water heater drain plug and close P-T relief valve.
15. Pour about one cup of non-toxic RV antifreeze into the kitchen sink drain, bathroom sink drain and shower drain. This prevents any holding tank odors from entering the coach during storage.

**WARNING**  
NEVER use automotive antifreeze/coolant in your RV water system. Auto antifreeze contains ethylene glycol which, if ingested, can cause blindness and can be fatal.

It is not necessary to add antifreeze to the toilet since the flush valve will be closed.

Do not add automotive antifreeze or caustic chemicals such as bleach or laundry detergents into the toilet bowl or holding tanks. Although these products may have a deodorizing effect, they may damage plastic and rubber parts in the system.

**NOTE:** *As an alternative to totally draining the plumbing system, you may winterize tanks and lines by pumping non-toxic RV antifreeze through the system. This product is available from your dealer and from most RV supply stores. Follow directions on the container to determine the correct amount to use for your coach.*

*See "RV ANTIFREEZE WATER LINE WINTERIZATION SYSTEMS" at the end of this section for instructions.*

**CAUTION**  
Leave by-pass valve handle in NORMAL FLOW position if draining water and blowing out water lines. Place in BYPASS position ONLY when using antifreeze solution in water lines.

16. Place a bucket beneath the sewage drain valve outlet and re-drain the sewage and waste holding tanks of any clean water that entered during "blow-out" procedure.

Close dump valves to prevent valve shafts from rusting and to prevent entry by rodents and insects. Refit the dust cap onto the drain outlet.

Your drainage and fresh water systems are now totally winterized.

17. Have the vehicle chassis completely serviced and lubricated. Be sure radiator antifreeze protection level is sufficient for the lowest anticipated temperatures.
18. Wash and wax the coach.
19. Inspect all seams and seals around doors, windows, vents, and any other joints. Replace or repair any that are damaged. Sealing materials and compounds can be purchased from your dealer. Badly damaged weather seals may need to be replaced by your dealer.
20. Close all windows and roof vents. Protect all appliance vent openings from contamination by animals or insects (e.g. bird nests, wasp nests, etc.)
21. Lubricate all door hinges and locks.
22. Clean the interior of the coach. Dirt and stains are more easily removed when fresh.
23. Remove all foods and items that may cause odors.
24. Clean and defrost the refrigerator. Leave the door slightly ajar to allow any odors to dissipate. Place an open box of baking soda inside the refrigerator to help absorb odors.
25. Turn the furnace thermostat switch on the bottom of the thermostat to OFF.
26. Turn auxiliary battery (Aux Batt) switch off and disconnect all chassis and auxiliary battery cables.
27. Fully charge all batteries. Batteries must have at least 80% charge to survive freezing temperatures and long periods of non-use.

*NOTE: We do not recommend leaving the shoreline plugged in continuously during storage periods because the batteries can lose electrolytic fluids and become damaged from continuous charging without periodic use. We recommend following regular battery inspection and maintenance, especially in cold weather. See "Battery Maintenance" on page 6-10 this section.*

## REMOVAL FROM STORAGE

1. Completely air out the motor home.
2. Have the entire LP gas system checked for leaks.
3. Check window operation.
4. Check cabinet and door hinges. Lubricate with penetrating oil, if necessary.
5. Close all faucets and drain valves that are open. If necessary, reconnect toilet water line and close flush valve.
6. Add a few gallons of water to the fresh water tank and check for leaks especially at junctions. Also make sure all hangers and supports are securely in place. Sanitize the water system as outlined under "Disinfecting the Fresh Water System" in Section 7.
7. Check operation of all faucets to be sure faucet washers have not hardened during storage.
8. Check sealing valve in the toilet for proper operation and lubricate with silicone spray.
9. Add water to the holding tank using the toilet flush pedal. Check to be sure dump valve seals tightly.
10. Check around all appliances for obstructions and ensure that all vent openings are clear.
11. Start refrigerator and check for proper cooling.
12. Clean paneling and counter surfaces and apply a thin coat of wax.
13. Replace batteries if necessary and check out electrical system to make sure all lights and electrical components operate.
14. Check tires for proper cold inflation pressure.
15. After washing accumulated winter grime from the vehicle, it is important to carefully inspect the seams and sealants for separation or cracks that may have appeared around the window frames, vents and any other joints. Re-sealing is quite simple and the material is quickly and easily applied. Appropriate compounds are available from your dealer. Also inspect weather seals around doors, etc., and if necessary, have a dealer replace immediately.

## RV ANTIFREEZE WATER LINE WINTERIZATION SYSTEMS

### Manual Winterization Valve - Standard

Your coach is equipped with a manually operated water line winterization system for your convenience in winterizing fresh water lines.

The system features a diverter valve and draw tube in-line between the tank and water pump, and uses the water pump to draw non-toxic RV water system antifreeze into the water lines. This feature is located near the water pump and drain valves.

couldn't find siphon3.pcx

### To Fill Lines with RV Water Line Antifreeze:

- Turn water heater by-pass valve to by-pass position.
- Remove and save the protective cap from the end of the draw tube.
- Insert the end of the tube into a container of RV antifreeze solution.
- Turn the diverter valve handle so that it points toward the draw tube.
- Turn a water pump switch on.
- Open each cold water faucet handle in the coach one at a time until antifreeze solution just begins to flow from the faucet, then close.

### When Done Adding RV Antifreeze:

- Turn water pump switch off.
- Turn the diverter valve handle so it points toward the water line to the pump as shown in the photo. This will stop the flow from the draw tube and revert the tank line flow to the pump.
- Replace the protective cap onto the end of the draw tube to keep out insects and debris when not in use.

### Automatic Winterization System - Optional

Your coach may be optionally equipped with an electric pump powered automatic water line winterization system for your convenience in winterizing fresh water lines.

The reservoir tank for the RV water system antifreeze is located in the slide-out cargo compartment on the driver side of the coach. Remove the large black square-headed plug and use a funnel to fill the tank. Capacity is approximately 2 gallons. The tank may require refilling before the system is completely filled.

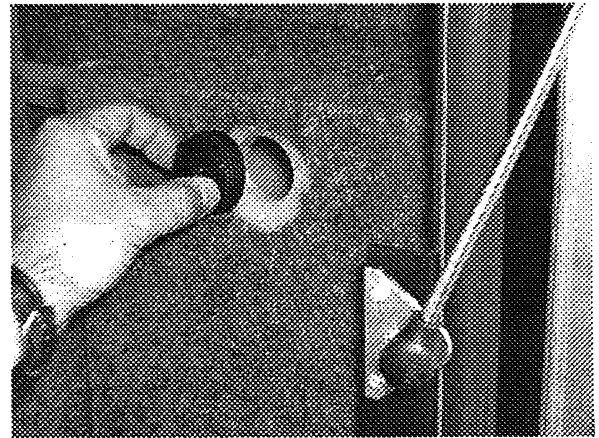

The winterization system switch panel is located behind the glass door above the microwave oven.

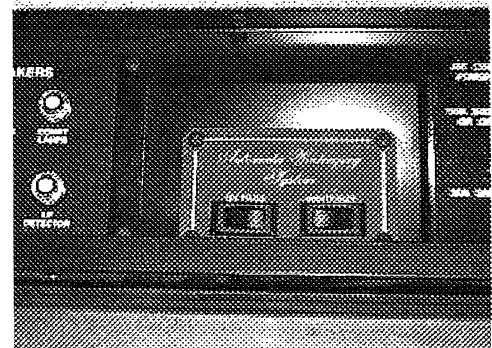

- Press the BYPASS switch to avoid filling the 6 gallon water heater tank with antifreeze after the draining the water heater at the service panel on the outside of the coach. If you should wish to fill the water heater tank with antifreeze solution, leave this switch off.
- Press the WINTERIZE switch to turn the winterizing pump system on to fill the lines with RV antifreeze solution.



# LUXOR

## INDEX

### A

Air Conditioner, Automotive ..... 2-13  
Air Conditioner, Central ..... 8-14  
Air Conditioner Filter ..... 8-15  
Alarm, LP Gas ..... 1-2  
Alignment, Front Axle Tire ..... 4-1  
Alignment, Suspension and Tire Balance ..... 9-7  
Amplifier, Antenna Signal ..... 8-16  
Antenna, CB SWR Adjustment ..... 2-15  
Antenna, TV ..... 8-15  
Antenna Signal Amplifier ..... 8-16  
Antifreeze, RV Winterization Systems ..... 10-5  
Automatic Winterizing System ..... 10-5  
Automotive (Starting) Batteries ..... 6-9  
Auto 12V Fuses & Circuit Breakers ..... 6-8, 9-6  
Auxiliary Battery Switch ..... 2-15  
Aux Start Switch ..... 2-14  
Auxiliary (Coach) Batteries ..... 6-9  
Auxiliary 110-Volt Generator ..... 6-6

### B

Bathroom, Care of ..... 9-3  
Batteries, Automotive (Starting) ..... 6-9  
Batteries, Auxiliary (Coach) ..... 6-9  
Battery Charger, Connecting ..... 3-2  
Battery Condition Meter ..... 6-10, 8-7  
Battery Information ..... 6-9  
Battery Maintenance ..... 6-9  
Battery Switch, Aux ..... 2-15  
Beds, Converting for use ..... 8-19  
Before Driving your Vehicle ..... 2-1  
Before Entering your Vehicle ..... 2-1  
Binder, Motor Home Operation Manual ..... 0-1  
Block Heater, Diesel Engine ..... 2-2  
Brake, Parking ..... 2-3  
By-Pass Valve, Water Heater ..... 8-12

### C

Cabinets ..... 9-3  
Cable TV Hook-Ups ..... 8-17  
Campsite Selection ..... 4-6  
Capacities\*  
Fuel Tank ..... 2-2  
Fresh Water Tank ..... 7-1

\* Capacity chart is also conveniently located on the back of "To The Owner" page inside front cover of this manual.

Holding Tanks ..... 7-5  
LP Gas Tank ..... 5-2  
Water Heater ..... 8-11  
Carbon Monoxide Alarm ..... 1-5  
Carbon Monoxide Warning ..... 1-4  
Carpets, Care of ..... 9-2  
CB Radio Wiring ..... 2-15  
Central Air Conditioner ..... 8-14  
Charger Panel, Solar ..... 6-8  
Charging Section, Converter ..... 6-5  
Chassis Operating Guide ..... 0-1  
Chassis Service and Maintenance ..... 9-4  
Checklists,  
Pre-Travel ..... 4-3  
Emergency Equipment ..... 4-3  
Quick Loading ..... 4-3  
Child Restraints ..... 2-9  
Circuit Breakers, 12-Volt ..... 6-8, 9-6  
Circuit Breakers, 110-Volt ..... 6-4  
City Water Hook-Up ..... 7-3  
Coach Leveling System ..... 2-15  
Cold Weather Storage (Winterizing) ..... 10-1  
Comfort Controls ..... 2-13  
Compact Disc (CD) Changer ..... 2-14  
Condensation, Humidity and ..... 4-7  
Connecting a Battery Charger ..... 3-2  
Connecting the Shoreline ..... 6-1  
Control Center, Video ..... 8-17  
Converter, Electrical Power ..... 6-3  
Cooling System, Engine ..... 9-5  
Couch/Bed Conversion ..... 8-19  
Cruise Control ..... 2-11

### D

DC-AC Electrical Inverter ..... 8-17  
Decals and Stripes ..... 9-1  
Defects, Reporting Safety ..... 0-2  
Defroster ..... 2-13  
Diesel Engine Block Heater ..... 2-2  
Diesel Fuel/Water Separator ..... 9-5  
Disinfection of Fresh Water Tank ..... 7-3  
Door Handles and Locks ..... 2-4  
Door Prop Latch, Entrance ..... 2-5  
Doors and Windows, Care of ..... 9-4  
Drain Valves, Water ..... 7-5  
Drainage System ..... 7-4  
Draperies, Care of ..... 9-3  
Drinking and Driving ..... 0-2

# L U X O R

## INDEX

|                                       |      |  |           |
|---------------------------------------|------|--|-----------|
| Driver Seat .....                     | 2-8  | Furnace , LP Gas .....                   | 8-12      |
| Driving Safety Precautions .....      | 1-1  | <b>G</b>                                 |           |
| Dual Rear Wheels .....                | 3-2  | Gas Alarm, LP .....                      | 1-2       |
| Dumping Holding Tanks .....           | 7-4  | Gas Leaks, LP .....                      | 5-4       |
| <b>E</b>                              |      | General Warnings .....                   | 1-1       |
| Effects of Prolonged Occupancy .....  | 4-7  | Generator, Auxiliary 110-Volt .....      | 6-6       |
| Electrical Inverter, DC-AC .....      | 8-17 | Generator Hourmeter .....                | 6-7       |
| Electrical Outlets, 110-volt .....    | 6-5  | Ground Fault Circuit Interrupter.....    | 6-5       |
| Electrical Safety Precautions .....   | 1-3  | <b>H</b>                                 |           |
| Electrical System, 110-volt AC .....  | 6-1  | Hazard Warning Flashers.....             | 2-4, 3-1  |
| Electrical System, 12-volt DC .....   | 6-8  | Heater, Engine Block .....               | 2-2       |
| Electronic Thermostat.....            | 8-13 | Heater, Automotive.....                  | 2-13      |
| Emergency Equipment Checklist.....    | 4-3  | Holding Tank Level Indicators .....      | 7-5, 8-10 |
| Emergency Exits .....                 | 1-5  | Hourmeter, Generator .....               | 6-7       |
| Engine Access.....                    | 9-4  | Humidity and Condensation .....          | 4-1       |
| Engine Block Heater, Diesel.....      | 2-2  | <b>I</b>                                 |           |
| Engine Cooling System .....           | 9-6  | Instrument Panel .....                   | 2-11      |
| Engine Overheat.....                  | 3-3  | Interior Care.....                       | 9-2, 9-3  |
| Engine Top Cover.....                 | 9-4  | Inverter, DC-AC Electrical .....         | 8-17      |
| Entertainment Center, Exterior .....  | 8-17 | <b>J</b>                                 |           |
| Entrance Door Lock and Handle.....    | 2-4  | Jump Starting .....                      | 3-1       |
| Entrance Door Prop Latch .....        | 2-5  | <b>K</b>                                 |           |
| Entrance Steps, Electric .....        | 2-6  | Keyless Entry System .....               | 2-5       |
| Entrance Stepwell Cover.....          | 2-7  | Keys .....                               | 2-2       |
| Equipment, Options and .....          | 0-1  | <b>L</b>                                 |           |
| Equipping for Travel.....             | 4-3  | Latch Mechanism, Entrance Door Prop..... | 2-5       |
| Exits, Emergency .....                | 1-5  | Leveling, Coach .....                    | 4-6       |
| Exterior Body Care .....              | 9-1  | Leveling System, Coach .....             | 2-15      |
| Exterior Entertainment Center.....    | 8-17 | Lights .....                             | 9-6       |
| Exterior Features.....                | 0-4  | Loading, Roof .....                      | 4-2       |
| Exterior Faucet.....                  | 7-4  | Loading the Vehicle .....                | 4-1       |
| External (City Water) Connector ..... | 7-3  | Locks, Entrance Door .....               | 2-4       |
| External Power Cord (Shoreline).....  | 6-1  | Locks, Power Door .....                  | 2-5       |
| <b>F</b>                              |      | LP Gas Alarm .....                       | 1-2       |
| Faucet Exterior.....                  | 7-4  | LP Gas Furnace .....                     | 8-12      |
| Filling the Fuel Tank.....            | 2-2  | LP Gas Leaks .....                       | 1-2, 5-4  |
| Filter, Central Air Conditioner.....  | 8-15 | LP Gas Level .....                       | 8-10      |
| Filter, Diesel Fuel/Water.....        | 9-6  | LP Gas Pressure Regulator .....          | 5-3       |
| Fire Extinguisher .....               | 1-5  | LP Gas Safety .....                      | 5-1       |
| Formaldehyde Warning .....            | 1-4  | LP Gas Selection.....                    | 5-1       |
| Fresh Water Tank.....                 | 7-1  | LP Gas Tank, Air in the .....            | 5-3       |
| Disinfection of .....                 | 7-3  | LP Gas Tank, Refilling .....             | 5-2       |
| Drain .....                           | 7-5  | LP Gas Tank System.....                  | 5-2       |
| Filling .....                         | 7-1  | LP Gas, Travel with .....                | 5-3       |
| Fresh Water Toilet .....              | 8-19 | LP Gas, Winter Use of .....              | 5-5       |
| Front Axle Tire Alignment .....       | 4-1  | Luggage Compartment Doors.....           | 2-7       |
| Fuel Selection .....                  | 2-2  |  |           |
| Fuel Tank Capacity .....              | 2-2  |  |           |
| Fuel Tank, Filling .....              | 2-2  |  |           |
| Fuel/Water Separator (Diesel) .....   | 9-5  |  |           |



### M

|   |      |
|---|------|
| Maximum Occupancy .....                   | 4-1  |
| Microwave Oven.....                       | 8-9  |
| Mirrors, Power Electric .....             | 2-7  |
| Monitor, Rearview TV.....                 | 2-8  |
| Monitor Panel .....                       | 8-10 |
| Motor Aid Water Heater .....              | 8-12 |
| Motor Home Operation Manual (Binder)..... | 0-1  |
| Mountain Driving .....                    | 4-6  |

### N

|                        |     |
|------------------------|-----|
| Nighttime Driving..... | 4-6 |
|------------------------|-----|

### O

|  |     |
|--|-----|
| Occupancy, Effects of Prolonged .....      | 4-7 |
| Occupancy, Maximum .....                   | 4-1 |
| Operating the Oven .....                   | 8-9 |
| Operation Manual (Binder), Motor Home .... | 0-1 |
| Operators Manual .....                     | 0-1 |
| Options and Equipment .....                | 0-1 |
| Outlets , 110-Volt .....                   | 6-5 |
| Oven Pilot .....                           | 8-9 |
| Overload Protector, Thermal .....          | 6-4 |

### P

|                                       |      |
|---------------------------------------|------|
| Parking Brake .....                   | 2-3  |
| Phone Jack Locations.....             | 8-17 |
| Pilot, Lighting Oven .....            | 8-9  |
| Power Converter .....                 | 6-3  |
| Power Door Locks .....                | 2-4  |
| Power Electric Mirrors.....           | 2-7  |
| Power Roof Vent .....                 | 8-20 |
| Power Seat, Driver Six-Way.....       | 2-8  |
| Power Step, Entrance .....            | 2-6  |
| Premium Sound System .....            | 2-14 |
| Pre-Travel Checklist .....            | 4-3  |
| Preparing Vehicle for Storage .....   | 10-1 |
| Pressure Regulator, LP Gas .....      | 5-3  |
| Prolonged Occupancy, Effects of ..... | 4-7  |
| Prop Latch, Entrance Door .....       | 2-5  |
| Pump Switch, Water .....              | 7-2  |

### Q

|                               |     |
|-------------------------------|-----|
| Quick Loading Checklist ..... | 4-3 |
|-------------------------------|-----|

### R

|                                  |      |
|----------------------------------|------|
| Radio Switch .....               | 2-14 |
| Radio Wiring, CB .....           | 2-15 |
| Range and Oven .....             | 8-8  |
| Range Hood .....                 | 8-9  |
| Rear Engine Access, Diesel ..... | 9-4  |
| Rearview TV Monitor.....         | 2-8  |

|  |      |
|--|------|
| Recovery Towing.....                     | 3-3  |
| Refrigerator .....                       | 8-1  |
| Regulator, LP Gas .....                  | 5-3  |
| Relief Valve, Water Heater.....          | 8-11 |
| Removal from Storage .....               | 10-4 |
| Reporting Safety Defects .....           | 0-2  |
| Restraints, Child.....                   | 2-10 |
| Roof Loading .....                       | 4-2  |
| Roof Maintenance.....                    | 9-1  |
| Roof Vent, Power .....                   | 8-20 |
| RV Antifreeze Winterization System ..... | 10-5 |

### S

|  |           |
|--|-----------|
| Safe Use of LP Gas System .....            | 5-1       |
| Safety Defects, Reporting .....            | 0-2       |
| Safety Precautions.....                    | 1-1       |
| Seat, Driver .....                         | 2-7       |
| Seat Belts and Child Restraints.....       | 2-9, 2-10 |
| Seats .....                                | 2-8       |
| Selecting Fuel Types, LP.....              | 5-1       |
| Service Assistance .....                   | 0-2       |
| Severe Weather Information .....           | 4-5       |
| Sewer Hook-Ups, Using On-Site .....        | 7-5       |
| Shoreline, Connecting the .....            | 6-1       |
| Shower Hose Vacuum Breaker.....            | 7-4       |
| Signal Amplifier, TV Antenna.....          | 8-16      |
| Sink, Stainless Steel .....                | 9-3       |
| Sleeping Facilities.....                   | 8-19      |
| Slider Windows.....                        | 8-21      |
| Solar Charger Panel .....                  | 6-8       |
| Speed Control (Cruise) .....               | 2-12      |
| Spots and Stains .....                     | 9-2       |
| Start Switch, Aux .....                    | 2-14      |
| Starting and Stopping the Engine .....     | 2-2       |
| Step, Electric Entrance .....              | 2-6       |
| Stepwell Cover.....                        | 2-7       |
| Storage, Preparing Vehicle for .....       | 10-1      |
| Storage, Removal from .....                | 10-4      |
| Stripes and Decals.....                    | 9-1       |
| Suspension Alignment and Tire Balance..... | 9-6       |
| Switch, Radio .....                        | 2-14      |
| SWR Adjustment, CB Antenna .....           | 2-15      |

### T

|   |      |
|---|------|
| Table and Countertop Surfaces.....          | 9-3  |
| Tank , Fresh Water Filling .....            | 7-1  |
| Tank Capacities, Water and Holding.....     | 7-6  |
| Telephone Hook-Ups.....                     | 8-17 |
| Thermal Overload Protector .....            | 6-4  |
| Thermostat, Electronic .....                | 8-13 |
| Tire Balance, Suspension Alignment and .... | 9-6  |
| Tire Changing .....                         | 3-1  |

# L U X O R

## INDEX

---

|                               |      |
|-------------------------------|------|
| Tires .....                   | 9-5  |
| Toilet, Fresh Water .....     | 8-19 |
| Towing, Recovery .....        | 3-1  |
| Trailer Towing .....          | 4-2  |
| Trailer Wiring Connector..... | 6-10 |
| Travel Tips .....             | 4-4  |
| Travel with LP Gas .....      | 5-3  |
| TV Antenna.....               | 8-15 |
| TV & Cable Hook-Ups, .....    | 8-17 |
| TV Signal Amplifier .....     | 8-16 |
| TV Monitor, Rearview .....    | 2-8  |

## U

|                                   |     |
|-----------------------------------|-----|
| Underbody Care.....               | 9-1 |
| Upholstery .....                  | 9-2 |
| Using On-Site Sewer Hook-Ups..... | 7-4 |

## V

|  |      |
|--|------|
| Vehicle Certification Label (VIN).....   | 0-3  |
| Vehicle Maintenance .....                | 9-4  |
| Vents, Power Roof.....                   | 8-20 |
| Video Control Center.....                | 8-17 |
| Vinyl Fabrics .....                      | 9-3  |
| Vinyl Wallboard .....                    | 9-3  |
| Voltage Inverter, DC-AC Electrical ..... | 8-17 |

## W

|                                     |      |
|-------------------------------------|------|
| Warnings:                           |      |
| Carbon Monoxide .....               | 1-4  |
| Driving .....                       | 1-1  |
| Formaldehyde .....                  | 1-4  |
| Fuel & LP Gas .....                 | 1-1  |
| LP Gas Leaks .....                  | 1-2  |
| LP Gas Alarm .....                  | 1-2  |
| Electrical .....                    | 1-3  |
| Loading .....                       | 1-3  |
| Maintenance.....                    | 1-4  |
| Warranty .....                      | 0-2  |
| Water and Holding Tank Levels ..... | 8-10 |
| Water Drain Valves .....            | 7-5  |
| Water Heater, Motor Aid .....       | 8-12 |
| Water Heater .....                  | 8-11 |
| Water Heater By-Pass Valve .....    | 8-12 |
| Water Heater Capacity.....          | 8-11 |
| Water Line Drain Valves .....       | 7-5  |
| Water Pump .....                    | 7-1  |
| Water Pump Switch .....             | 7-2  |
| Water Tank, Disinfection of .....   | 7-2  |
| Water Tank Filling .....            | 7-1  |
| Weighing Your Loaded Vehicle .....  | 4-1  |
| Windows, Cleaning .....             | 9-4  |
| Windows, Slider .....               | 8-21 |

|   |      |
|---|------|
| Windows, Doors and .....                  | 9-4  |
| Windows, Emergency Exit .....             | 1-5  |
| Windshield Washers and Wipers.....        | 9-6  |
| Windshield Wiper/Washer Switch.....       | 2-13 |
| Winter Use of LP Gas .....                | 5-5  |
| Winterizing .....                         | 10-1 |
| Winterization Valve, Manual.....          | 10-5 |
| Winterization Systems, RV Antifreeze..... | 10-5 |
| Wiring, CB Radio .....                    | 2-15 |

---

**IMPORTANT  
SERIAL NUMBERS**

Motor Home (Coach): Year \_\_\_\_\_ Model \_\_\_\_\_ Serial \_\_\_\_\_

Chassis: Make \_\_\_\_\_ Serial (VIN) \_\_\_\_\_

Roof Air Conditioner:      Brand \_\_\_\_\_ Model \_\_\_\_\_ Serial \_\_\_\_\_

Furnace:                      Brand \_\_\_\_\_ Model \_\_\_\_\_ Serial \_\_\_\_\_

Water Heater:              Brand \_\_\_\_\_ Model \_\_\_\_\_ Serial \_\_\_\_\_

Power Converter:          Brand \_\_\_\_\_ Model \_\_\_\_\_ Serial \_\_\_\_\_

110-Volt Generator:      Brand \_\_\_\_\_ Model \_\_\_\_\_ Serial \_\_\_\_\_

Range                         Brand \_\_\_\_\_ Model \_\_\_\_\_ Serial \_\_\_\_\_

Microwave Oven:          Brand \_\_\_\_\_ Model \_\_\_\_\_ Serial \_\_\_\_\_

Refrigerator                Brand \_\_\_\_\_ Model \_\_\_\_\_ Serial \_\_\_\_\_

Television:                 Brand \_\_\_\_\_ Model \_\_\_\_\_ Serial \_\_\_\_\_

Video Cassette Player:    Brand \_\_\_\_\_ Model \_\_\_\_\_ Serial \_\_\_\_\_

**EMERGENCY INFORMATION**

**Dealer**

Name \_\_\_\_\_

Address \_\_\_\_\_

Phone \_\_\_\_\_

**INSURANCE POLICY**

Company \_\_\_\_\_

Policy Number \_\_\_\_\_

Phone \_\_\_\_\_





