

# BRAVE

## TO THE OWNER

---

Congratulations! We welcome you to the exciting world of motor home travel and camping. You will find it convenient and enjoyable to have all the comforts of home and still enjoy the great outdoors wherever you choose to go.

Your motor home has been carefully designed, engineered and manufactured to provide dependability as well as safety. Before sliding into the driver's seat, take a few minutes to become familiar with operations and features. This manual was prepared to aid you in the proper care and operation of the vehicle and equipment. We urge you to read it completely. In addition, spend some time with the dealer when you take delivery, you will want to learn all you can about your new motor home.

Your new motor home is covered by a factory warranty against defects in material and workmanship. This warranty should be validated at once and returned to the factory by your dealer.

Read and understand all instructions and precautions in this manual before operating your new motor home.

### About Safety Messages Used in This Manual

Throughout this manual, certain items are labeled Note, Caution, Warning or Danger. These terms alert you to precautions that may involved damage to your vehicle or a risk to your personal safety. Read and follow them carefully.



This SAFETY ALERT SYMBOL is used to draw your attention to issues which could involved potential personal injury. This symbol is used throughout this manual and/or on labels affixed on or near various equipment in this motor home.



### DANGER

DANGER indicates a directly hazardous situation which, if not avoided, will result in death or serious personal injury.



### WARNING

WARNING indicates a potentially hazardous situation which, if not avoided, could result in death or serious personal injury.



## CAUTION

CAUTION indicates a potentially hazardous situation which, if not avoided, could result in damage mainly to equipment or property, but in some cases may also result in minor or moderate personal injury.

*NOTE: A 'Note' is not necessarily safety related but indicates a recommendation or special point of information that could assist in understanding the use or care of a feature item.*

---

|  |
|--|
| OWNER'S NAME                               |
| STREET ADDRESS                             |
| CITY AND STATE (OR PROVINCE IN CANADA)     |
| MOTOR HOME SERIAL NUMBER                   |
| VEHICLE CHASSIS IDENTIFICATION NO. (VIN)   |
| DATE OF DELIVERY TO FIRST RETAIL PURCHASER |
| VEHICLE MILEAGE AT TIME OF DELIVERY        |
| SELLING DEALER NAME AND ADDRESS            |

### TANK CAPACITIES



**Chassis Fuel Tank**..... 75 gal.



**LP Gas Tank**

Brave model 30W ..... 18 gal.\* (23 gal. w.c.)  
 Brave models 32V, 34D, 36M..... 23 gal.\* (28 gal. w.c.)



**Fresh Water Tank**

Brave model 30W ..... 78 gal.  
 Brave model 32V ..... 80 gal.  
 Brave model 34D ..... 80 gal.  
 Brave model 35M..... 80 gal.



**Water Heater - All Models**..... 6 gal.



**HT1 - Black Water Holding Tank**

Brave model 30W (Toilet) ..... 40 gal.  
 Brave model 32V (Toilet) ..... 50 gal.  
 Brave model 34D (Toilet) ..... 40 gal.  
 Brave model 36M (Toilet)..... 40 gal.



**HT2 - Gray Water Holding Tank**

Brave model 30W (Galley, Shower & Lavatory)..... 54 gal.  
 Brave model 32V (Galley, Shower & Lavatory) ..... 50 gal.  
 Brave model 34D (Galley, Shower & Lavatory) ..... 45 gal.  
 Brave model 36M (Galley Shower & Lavatory)..... 50 gal.

*\*LP Gas tank capacity shown is the usable "full" LP gas capacity, which is 80% of the tank manufacturer's listed water capacity (w.c. shown in parenthesis). An LP tank must have at least 20% of tank volume free to allow for expansion and proper vaporization of the liquid fuel. The tank is also equipped with mandatory safety shut-off equipment that prevents filling above this level.*



**2003 NEW VEHICLE LIMITED WARRANTY  
WINNEBAGO INDUSTRIES, INC.**

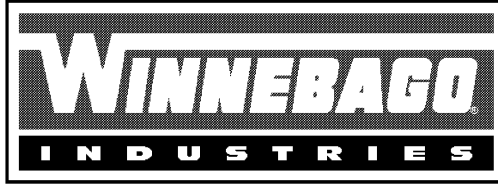

**WARRANTY COVERAGE TO OWNER**

Winnebago Industries, Inc. of Forest City, Iowa warrants each Winnebago Industries motor home to the owner for use in the U.S.A. and Canada as follows:

**WARRANTY PERIOD**

The Warranty Period for all coverages begins on the date the vehicle is delivered to the first retail purchaser or first placed in service as a demonstrator or company vehicle.

**BASIC COVERAGE**

The basic Warranty Period is 12 months or 15,000 miles (24,135 kilometers), on the odometer, whichever occurs first. Winnebago Industries does not authorize any person to create for it any other obligations or liability in connection with this vehicle. ANY IMPLIED WARRANTY OF MERCHANTABILITY OR FITNESS FOR A PARTICULAR PURPOSE APPLICABLE TO THIS VEHICLE IS LIMITED IN DURATION TO THE DURATION OF THIS WRITTEN WARRANTY AS HEREINBEFORE OR HEREINAFTER PROVIDED. THE PERFORMANCE OF REPAIRS IS THE EXCLUSIVE REMEDY UNDER THIS WRITTEN WARRANTY OR ANY IMPLIED WARRANTY. WINNEBAGO INDUSTRIES SHALL NOT BE LIABLE FOR INCIDENTAL OR CONSEQUENTIAL DAMAGES FOR LOSS OF TIME, INCONVENIENCE, OR OTHER CONSEQUENTIAL DAMAGE INCLUDING EXPENSE FOR GASOLINE, TELEPHONE, TRAVEL, LODGING, LOSS OR DAMAGE TO PERSONAL PROPERTY, OR LOSS OF REVENUE RESULTING FROM BREACH OF THIS WRITTEN WARRANTY OR ANY IMPLIED WARRANTY. Some states do not allow limitations on how long an implied warranty will last or the exclusion or limitation of incidental or consequential damages, so the above limitations or exclusions may not apply to you.

**ITEMS NOT SUBJECT TO WARRANTY COVERAGE.**

- Chassis\*
- Wheels\*
- Tires\*
- Service Items, such as Windshield Wiper Blades, Lubricants, Fluids & Filters
- Adjustments

\*These items are covered under the manufacturer's individual warranty.

This warranty gives you specific legal rights and you may also have other rights which vary from state to state.

Also, this warranty shall not apply to failures, damage or malfunctions resulting from normal wear, misuse, abuse, negligence, alteration, accident, fire, improper repair of the vehicle or failure to follow recommended maintenance requirements.

**36 MONTHS/36,000 MILE STRUCTURAL WARRANTY**

At the expiration of the Basic Coverage and for the remainder of the period of 36 months or 36,000 miles (57,924 kilometers), on the odometer, whichever occurs first, Winnebago Industries warrants the following:

1. Body Thermo-Panel® Lamination of the sidewalls and backwall against delamination. Body Thermo-Panel® Lamination is the bonding of the exterior skin and the interior paneling to an insulating core material. Delamination (separation of layers) caused by other factors such as physical damage or failure to properly maintain sealants is not covered by this warranty.
2. The slide-out room assembly for defects in material or workmanship.
3. Structural defects of the subfloor and floor. Floor lamination failure and lamination failure of the subfloor panels and risers are covered by the structural warranty.

\_\_\_\_\_  
\_\_\_\_\_  
\_\_\_\_\_

PLACE  
STAMP  
HERE

Winnebago Industries, Inc.  
P.O. Box 152  
Forest City, Iowa 50436

ATTENTION: WARRANTY DEPT.

**WINNEBAGO INDUSTRIES' RESPONSIBILITY**

Any part of the vehicle subject to warranty which is found to be defective in material or workmanship, will be repaired or replaced at Winnebago Industries' option upon notice of the defect without charge to the customer for parts or labor. While any Winnebago Industries motor home dealer can perform warranty service, we recommend you return to the dealership that sold you your vehicle. If you are touring or have moved, contact any Winnebago Industries motor home dealer in the United States or Canada for warranty service.

**CUSTOMER RESPONSIBILITY WHEN REPAIRS ARE NEEDED**

If a part of the system covered by this warranty fails to function or requires service during the warranty period:

1. Promptly take the vehicle to the selling dealer for repair or inspection.
2. Written notice of defects must be given to the selling dealer or manufacturer no later than 10 days after the expiration of the warranty.
3. If the dealer is incapable of making the repairs, request that he contact Winnebago Industries, Inc.
4. If, after the above steps are completed and the repair is not made, the customer should contact Winnebago Industries, Inc., P.O. Box 152, Forest City, Iowa 50436, Attention: Owner Relations Department (800-537-1885) and furnish the following information:
  - The complete serial number of the vehicle
  - Date of retail purchase
  - Selling dealer's name
  - Nature of the service problem, and a brief explanation of the steps or service the dealer has performed, and the results obtained. The customer may be directed to another dealer or service center for repairs to be completed, if such a dealer or service center is better able to complete the repair.

Winnebago Industries may, at its option, request the vehicle be returned to Forest City, Iowa for repair. If the customer refuses to allow repairs to be performed at the Forest City, Iowa facility, the warranty on that repair will be voided.

5. If after the above steps are completed and the repairs are not satisfactory, the customer may contact the Service Administration Manager of Winnebago Industries, and request a customer relations board meeting to resolve the problem. This action, however, is not mandatory.
6. Certain components are covered beyond the 12 months/15,000 miles basic warranty coverage by the individual manufacturer's warranty. Please refer to the component's information supplied in the owner's information InfoCase for any additional warranty coverage after the basic warranty has expired.

**DEALER'S REPRESENTATIONS EXCLUDED**

Winnebago Industries, Inc. does not undertake the responsibility to any purchaser of its products for any undertaking, representation, or warranty made by dealers selling its product beyond those herein expressed.

**INSTALLATION NOT COVERED**

Winnebago Industries, Inc. cannot, however, and does not accept any responsibility in connection with any of its motor homes for additional equipment or accessories installed at any dealership or other place of business, or by any other party other than Winnebago Industries, Inc. Such installation of equipment or accessories by any other party will not be covered by the terms of this warranty.

**CARE AND MAINTENANCE**

It is the owner's responsibility to perform the care, maintenance and proper load distribution described in the owner's manual which accompanies your motor home. Any damage which results to your vehicle as a result of your failure to perform such duties, is not covered.

Damage to appearance items such as fiberglass, metal, paint, fabrics and trim, may occur during manufacturing or transporting. Normally, any factory defect or damage is corrected at the factory. In addition, dealers are obligated to inspect each vehicle upon delivery to them and prior to delivery to you. You should also immediately inspect appearance items and advise your selling dealer of any discrepancies. Damage and normal deterioration due to use and exposure is not covered by this warranty.

**CHANGES IN DESIGN**

Winnebago Industries, Inc. reserves the right to make changes in design and changes or improvements upon its products without imposing any obligation upon itself to install the same upon its products theretofore manufactured.

**NEW YORK:**

If your motor home has been repaired three or more times for the same nonconformity, defect, or condition, or if your motor home has been out of service by reason of repair for twenty-one days, Section 198-a of the General Business Law of the State of New York requires you to provide written notice by certified mail, return receipt requested, to Winnebago Industries or its authorized dealer before making any claim under that section of the law. If you do have problems with your motor home, you should provide written notice to Winnebago Industries at the following address:

Winnebago Industries, Inc.  
 P.O. Box 152  
 Forest City, Iowa 50436  
 Atten: Owner Relations

PART NO. 701677-K2-003 5-02

-----CUT HERE-----

**NOTICE OF SECOND OWNER**

|  |                     |          |
|--|---------------------|----------|
| ORIGINAL OWNER                             | NAME                |          |
|  | ADDRESS             |          |
| NEW OWNER                                  | NAME                |          |
|  | ADDRESS             | ZIP CODE |
| WINNEBAGO INDUSTRIES IDENTIFICATION NUMBER | VEHICLE MILEAGE     | DATE     |
| CHASSIS IDENTIFICATION                     | NEW OWNER SIGNATURE |          |

**IMPORTANT:** THIS NOTICE IS TO BE USED ONLY FOR RECORD KEEPING BY WINNEBAGO INDUSTRIES  
 The completed form does not constitute an actual change of ownership.

# BRAVE

## TABLE OF CONTENTS

### INTRODUCTION

|                                      |      |
|--------------------------------------|------|
| About This Manual .....              | 0- 1 |
| Chassis Operating Guide .....        | 0- 1 |
| Owner's InfoCase .....               | 0- 1 |
| Options and Equipment .....          | 0- 1 |
| Before Driving .....                 | 0- 2 |
| Service and Assistance.....          | 0- 2 |
| Warranty .....                       | 0- 2 |
| Drinking and Driving.....            | 0- 2 |
| Reporting Safety Defects .....       | 0- 2 |
| Vehicle Certification Label.....     | 0- 4 |
| Exterior Feature Identification..... | 0- 5 |

### SECTION 1: SAFETY PRECAUTIONS

|   |      |
|---|------|
| General Warnings .....                    | 1- 1 |
| Driving .....                             | 1- 2 |
| Fuel & LP Gas .....                       | 1- 2 |
| LP Gas Leaks .....                        | 1- 3 |
| LP Gas Alarm .....                        | 1- 3 |
| Electrical .....                          | 1- 4 |
| Loading .....                             | 1- 5 |
| Maintenance.....                          | 1- 5 |
| Formaldehyde Information .....            | 1- 5 |
| Carbon Monoxide Warning .....             | 1- 5 |
| Carbon Monoxide Alarm .....               | 1- 6 |
| Emergency Exits .....                     | 1- 6 |
| Swing Out Rear Escape Window.....         | 1- 7 |
| Using Slider Windows as Emergency Exits . | 1- 7 |
| Fire Extinguisher.....                    | 1- 7 |
| Smoke Alarm .....                         | 1- 8 |

### SECTION 2: DRIVING YOUR MOTOR HOME

|                                    |      |
|------------------------------------|------|
| Before Entering Your Vehicle ..... | 2- 1 |
| Before Driving Your Vehicle .....  | 2- 1 |
| Keys .....                         | 2- 2 |
| Fuel Selection .....               | 2- 2 |
| Gasoline Fuel Fill.....            | 2- 2 |
| Starting and Stopping Engine ..... | 2- 3 |
| Parking Brakes .....               | 2- 3 |
| Hazard Warning Lights.....         | 2- 3 |
| Entrance Door Lock and Handle..... | 2- 3 |
| Electric Entrance Step.....        | 2- 4 |
| Seats .....                        | 2- 5 |
| Lap Belts .....                    | 2- 6 |

|   |       |
|---|-------|
| Child Restraints.....                     | 2- 7  |
| Mirrors .....                             | 2- 8  |
| Rearview TV Monitor System.....           | 2- 9  |
| Instrument Panel Gauges and Controls..... | 2- 9  |
| Multi-Function Signal Lever .....         | 2- 11 |
| Headlight Beam Change and Turn Signal ..  | 2- 11 |
| Windshield Wipers and Wiper Delay .....   | 2- 11 |
| Cruise Control.....                       | 2- 11 |
| Comfort Controls .....                    | 2- 11 |
| Heating.....                              | 2- 11 |
| Defrosting .....                          | 2- 11 |
| Ventilation .....                         | 2- 12 |
| Air Conditioning .....                    | 2- 12 |
| Rear Coach Heater .....                   | 2- 12 |
| Battery Boost Switch .....                | 2- 12 |
| Auxiliary Battery (Aux. Batt) Switch..... | 2- 12 |
| Beverage Tray .....                       | 2- 13 |
| Coach Leveling Systems.....               | 2- 13 |
| Slideout Room .....                       | 2- 15 |
| Travel Straps .....                       | 2- 15 |

### SECTION 3: IN CASE OF DRIVING EMERGENCY

|  |      |
|--|------|
| Hazard Warning Flasher .....             | 3- 1 |
| Spare Tire Storage .....                 | 3- 1 |
| Motor Home Tire Changing Procedure ..... | 3- 2 |
| Safety Precautions.....                  | 3- 2 |
| Front Wheel .....                        | 3- 2 |
| Dual Rear Wheels .....                   | 3- 2 |
| Wheel Nuts .....                         | 3- 3 |
| Recovery Towing.....                     | 3- 3 |
| Jump Starting .....                      | 3- 4 |
| Connecting Jumper Cables .....           | 3- 4 |
| Connecting A Battery Charger .....       | 3- 5 |
| Engine Overheat .....                    | 3- 5 |

### SECTION 4: TRAVELING WITH YOUR MOTOR HOME

|                                    |      |
|------------------------------------|------|
| Loading the Vehicle.....           | 4- 1 |
| Front Axle Tire Alignment .....    | 4- 1 |
| Weighing Your Loaded Vehicle ..... | 4- 1 |
| Maximum Occupancy .....            | 4- 2 |
| Roof Loading .....                 | 4- 2 |
| Car or Trailer Towing .....        | 4- 2 |
| Pre-Travel Checklist .....         | 4- 3 |

## TABLE OF CONTENTS

# BR AVE

|                                     |      |
|-------------------------------------|------|
| Equipping for Travel.....           | 4- 4 |
| Travel Tips.....                    | 4- 4 |
| Severe Weather Information.....     | 4- 5 |
| Nighttime Driving.....              | 4- 6 |
| Mountain Driving.....               | 4- 6 |
| Campsite Selection.....             | 4- 6 |
| Leveling.....                       | 4- 6 |
| Blocking.....                       | 4- 6 |
| Effects of Prolonged Occupancy..... | 4- 7 |
| Humidity and Condensation.....      | 4- 7 |

### SECTION 5: LP GAS SYSTEM

|                                    |      |
|------------------------------------|------|
| LP Gas Supply.....                 | 5- 1 |
| Safe Use of the LP Gas System..... | 5- 1 |
| How LP Gas Works.....              | 5- 1 |
| LP Gas Output.....                 | 5- 2 |
| LP Tank System.....                | 5- 2 |
| Selecting LP Fuel Types.....       | 5- 2 |
| Refilling LP Tank.....             | 5- 3 |
| Air in the LP Gas Tank.....        | 5- 3 |
| Travel with LP Gas.....            | 5- 3 |
| Regulator.....                     | 5- 4 |
| LP Gas Leaks.....                  | 5- 4 |
| Winter Use of LP Gas.....          | 5- 5 |

### SECTION 6: ELECTRICAL SYSTEMS

|  |      |
|--|------|
| 110-Volt AC System.....                          | 6- 1 |
| External Power Cord (Shoreline).....             | 6- 1 |
| Powerline Energy Management System<br>(EMS)..... | 6- 2 |
| Power Center (Converter).....                    | 6- 2 |
| Charging Section.....                            | 6- 3 |
| Thermal Overload Protector.....                  | 6- 3 |
| 110-Volt Circuit Breakers.....                   | 6- 3 |
| 110-Volt Receptacles.....                        | 6- 3 |
| Ground Fault Circuit Interrupter.....            | 6- 4 |
| Auxiliary 110-Volt Generator.....                | 6- 4 |
| Starting and Stopping the Generator.....         | 6- 4 |
| Generator Hourmeter.....                         | 6- 5 |
| 12-Volt DC System.....                           | 6- 6 |
| Chassis (Starting) Battery.....                  | 6- 6 |
| House Batteries.....                             | 6- 6 |
| 12-Volt House Fuses and Circuit Breakers..       | 6- 6 |
| Battery Access.....                              | 6- 7 |
| Battery Storage and Maintenance.....             | 6- 7 |
| Aux. Start Switch.....                           | 6- 9 |
| Auxiliary Battery Switch.....                    | 6- 9 |
| CB Radio Wiring.....                             | 6- 9 |

|                               |       |
|-------------------------------|-------|
| SWR Adjustment.....           | 6- 9  |
| Trailer Wiring Connector..... | 6- 10 |

### SECTION 7: PLUMBING SYSTEMS

|   |      |
|---|------|
| Fresh Water System.....                 | 7- 1 |
| Water Pump.....                         | 7- 2 |
| Disinfecting Fresh Water Systems.....   | 7- 3 |
| Water Purifier (Filter) System.....     | 7- 3 |
| External Water Supply (City Water)..... | 7- 4 |
| Shower Hose Vacuum Breaker.....         | 7- 5 |
| Exterior Shower\Wash Station.....       | 7- 5 |
| Waste Water System (Holding Tanks)..... | 7- 5 |
| Dumping Holding Tanks.....              | 7- 6 |
| Water Line & Tank Drain Valves.....     | 7- 6 |
| Tank Capacities.....                    | 7- 8 |
| Water System Drain Valve Locations..... | 7- 9 |

### SECTION 8: APPLIANCES AND INTERIOR FEATURES

|  |       |
|--|-------|
| Refrigerator.....                        | 8- 1  |
| Range and Oven.....                      | 8- 4  |
| Operating Oven Control.....              | 8- 6  |
| Microwave Oven.....                      | 8- 6  |
| Range Hood.....                          | 8- 6  |
| Water Heater.....                        | 8- 8  |
| Motor Aid.....                           | 8- 9  |
| LP Gas Furnace.....                      | 8- 10 |
| Heat Pump.....                           | 8- 10 |
| Ducted Roof Air Conditioning System..... | 8- 11 |
| TV Antenna.....                          | 8- 12 |
| TV Signal Amplifier.....                 | 8- 13 |
| Signal Amplifier.....                    | 8- 13 |
| Checking Performance.....                | 8- 14 |
| Cable TV Hook-Up.....                    | 8- 14 |
| Video Control Center.....                | 8- 14 |
| DC-AC Electrical Voltage Inverter.....   | 8- 15 |
| Exterior Entertainment Center.....       | 8- 15 |
| Sleeping Facilities.....                 | 8- 15 |
| Couch Bed Conversion.....                | 8- 15 |
| Rest Easy Multi-Position Lounge.....     | 8- 15 |
| Swivel Glider Lounge Chair.....          | 8- 17 |
| Fresh Water Toilet.....                  | 8- 17 |
| Cleaning the Toilet.....                 | 8- 18 |
| Power Roof Vent.....                     | 8- 18 |
| Crank-Out Side Windows.....              | 8- 18 |
| Slider Windows.....                      | 8- 19 |
| Day/Nighter Pleated Blinds.....          | 8- 19 |
| Quartz Wall Clock.....                   | 8- 19 |



Coffee Maker ..... 8- 20

### **SECTION 9: CARE AND MAINTENANCE**

Roof ..... 9- 1  
Underbody ..... 9- 1  
Exterior ..... 9- 1  
Care of Stripes and Decals..... 9- 2  
Cabinetry..... 9- 5  
Vinyl Wallboard ..... 9- 5  
Tables and Countertops ..... 9- 5  
Stainless Steel Sink..... 9- 5  
Range and Refrigerator..... 9- 5  
Bathroom ..... 9- 5  
Doors and Windows..... 9- 5  
Engine Access..... 9- 6  
Engine Cover ..... 9- 6  
Engine Cooling System ..... 9- 6  
Tires ..... 9- 7  
Suspension Alignment and Tire Balance..... 9- 7  
Front Air Springs ..... 9- 7  
Windshield Washers and Wipers..... 9- 7  
Lights ..... 9- 8  
Automotive 12-Volt Fuses and  
Circuit Breakers ..... 9- 8

### **SECTION 10: STORING YOUR MOTOR HOME**

Preparing Vehicle for Storage..... 10- 1  
Cold Weather Storage Procedure  
(Winterizing)..... 10- 1  
Water System Winterization Valve ..... 10- 4  
Removal from Storage ..... 10- 6

---



# BRAVE

## INTRODUCTION



Congratulations on the purchase of your new Brave motor home, which has been carefully designed, engineered and quality built by Winnebago Industries, Inc.



### ABOUT THIS MANUAL

Please read this operator's manual completely to understand how everything in your coach works before taking it on its "maiden voyage."

This manual is a guide to safe operation of the features, equipment and controls in this coach. Some equipment, such as the vehicle chassis and certain electronic systems or appliances, have their own comprehensive, manufacturer supplied manuals or information sheets which describe operation of these products in great detail. This manual will refer you to the manufacturer's information included in your Owner *INFOCASE* whenever necessary.

**SUBJECT ICONS** - To make it easier for you to find information you're looking for, we have placed convenient, pictorial symbols called "icons" beside many of the subject headings in this manual. The icons correspond to the subject matter of the section. These icons were designed similar to the familiar international symbols which identify public facilities such as restrooms and handicap access. There are several examples of icons on this page.

**PAGE ICONS** - The icons at the upper corners of each page correspond to the primary content of each main section of the manual, such as LP Gas, Electrical, Plumbing, etc. This means you can flip through the manual either forward or backward and know exactly which main section you are looking for just by watching the icons at the top of the page. This means less paging back and forth.

**We also urge you to read the complete Chassis Operating Guide provided by the chassis maker and all other operating information provided by our equipment suppliers and manufacturers.** This is contained in your Owner *INFOCASE*<sup>TM</sup>.

This manual should be kept in the vehicle at all times for personal reference. The operator's manual, *INFOCASE* and chassis operating guide are to be considered permanent components of this vehicle. They should remain in the vehicle when sold to provide the next owner with important safety, operating and maintenance information.

*NOTE: The descriptions, illustrations, and specifications in this manual were correct at the time of printing. We reserve the right to change specifications or design without notice, and without incurring obligation to install the same on products previously manufactured.*



### CHASSIS OPERATING GUIDE

Throughout this manual, frequent reference is made to the chassis operating guide. The chassis guide is the operator's manual provided by the manufacturer of the chassis on which this motor home is built (i.e., Ford or Workhorse). Consult the chassis guide for operating safety and maintenance instructions pertaining to the chassis section of the motor home.

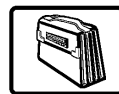

### OWNER'S INFOCASE

Your InfoCase contains information supplied by manufacturers of individual appliances and equipment installed in your motor home.

Consult this information regarding the operation and care of appliances, accessories and special equipment.

### OPTIONS AND EQUIPMENT

This model is available in several sizes and floorplans, so accessories and components may differ slightly between models. Some equipment described in this manual may not apply to your coach.



---

## BEFORE DRIVING

Before sitting in the driver’s seat, always check around your vehicle to be sure you have proper clearance for maneuvering. If necessary, have a passenger help guide you out of a difficult parking space.

Although your coach features automotive conveniences like power steering and power brakes, driving a motor home is different from driving a car. A motor home is larger and heavier than an automobile, so it requires more stopping and passing distance, and more parking and maneuvering space than does a car.

Always be aware of the size of your motor home. The added height of roof air conditioners, TV antennas or luggage boxes may cause clearance problems around some tunnels, canopies and hanging signs. Know the height of your unit so you can observe posted clearance limits. Also, remember that some bridges, old ones in particular, may not support the weight of your motor home. Know the weight of your unit and observe any posted weight limits.

Remember: Always use your seat belt and be sure your passengers do so as well. We also advise making frequent rest stops while traveling to relieve stress on yourself, your passengers and your vehicle.

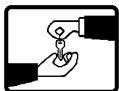

## SERVICE AND ASSISTANCE

Your dealer will be glad to provide any additional information you need, as well as answer any questions you might have about operating the equipment in your motor home. When it comes to service, remember that your dealer knows your vehicle best and is interested in your satisfaction. Your dealer will provide quality maintenance and any other assistance that you may require during your ownership of this vehicle.

If you need warranty repairs while traveling, however, you may take your motor home to any Winnebago or Itasca dealership and they will assist you.

---



## WARRANTY

Your new vehicle is covered by a factory warranty against defects in material and workmanship. This warranty should be validated immediately and returned to the factory by your dealer. For additional information, see your “New Vehicle Limited Warranty” included with this vehicle.



## DRINKING AND DRIVING

Winnebago Industries supports the recommendations of the Presidential Commission on Drunk Driving.

- Exercise your good judgment and encourage others to do the same.
- Know the legal limits and do not exceed them.
- Also know your personal limits, which may be lower than the legal limits.
- Should you ever exceed your limits, find alternative transportation; call a cab, ask a friend to drive you home or call a family member to come and get you.

The presence of alcohol in significant levels in the blood increases the probability that the driver will be involved in an accident.

---

## REPORTING SAFETY DEFECTS

If you believe that your vehicle has a defect which could cause a crash or could cause injury or death, you should immediately inform the National Highway Traffic Safety Administration (NHTSA) in addition to notifying Winnebago Industries, Inc.

If NHTSA receives similar complaints, it may open an investigation, and if it finds that a safety defect exists in a group of vehicles, it may order a recall and remedy campaign. However, NHTSA cannot become involved in individual problems between you, your dealer, or Winnebago Industries.



---

To contact NHTSA, you may either call the Auto Safety Hotline toll-free at 1-800-424-9393 (or 366-0123 in Washington, D.C. area) or write to: NHTSA, U.S. Department of Transportation, Washington, D.C. 20590. You can also obtain other information about motor vehicle safety from the Hotline.



## VEHICLE CERTIFICATION LABEL

This label contains vehicle identification and other important reference information. The vehicle certification label is located on the sidewall to the left of the steering wheel, or on the driver's door. Never remove or destroy this label.

|  |  |   |  |
|--|--|---|--|
| MANUFACTURED BY<br>                             |  | INCOMPLETE VEHICLE MANUFACTURED<br>BY ① MOTOR CORP.                     |  |
| ③<br>GAWR:   |  | MONTH AND YEAR OF MANUFACTURE: ②<br>GVWR ④ LB _____ KG                  |  |
| FRT _____ LB _____ KG<br>RR. ⑤ LB _____ KG   | SUITABLE TIRE AND RIM CHOICE<br>TIRE _____ ⑥ _____ ⑦ | COLD INFLATION PRESSURE<br>PSI _____ KPA SINGLE _____ ⑧ PSI _____ KPA ⑨ |  |
| THIS VEHICLE CONFORMS TO ALL APPLICABLE FEDERAL MOTOR VEHICLE SAFETY STANDARDS IN EFFECT ON THE DATE OF MANUFACTURE SHOWN ABOVE. |  |   |  |
| SERIAL NO. ⑩ _____<br>TYPE _____ ⑫   |  | VIN _____ ⑪ _____<br>MODEL _____ ⑬ _____ COLOR _____ ⑭                  |  |

### EXPLANATION OF DATA

1. Chassis manufacturer.
2. Chassis manufacture date.
3. Month and year of manufacture at Winnebago Industries.
4. Gross Vehicle Weight Rating: Total permissible weight of the vehicle, including driver, passengers, total cargo carried (including all liquids) and equipped with all options.
5. Gross Axle Weight Rating: Total permissible weight allowed for the front, and rear axles (listed in pounds and kilograms).
6. Suitable Tire Choice: Tires recommended to meet handling and safety requirements. When replacing any of the tires on your vehicle, always replace with a tire that meets these specifications.
7. Suitable Rim Choice: Wheel rims recommended to meet handling and safety requirements. When replacing any of the rims on your vehicle, always replace with a rim that meets these specifications.
8. Cold Inflation Pressure: Inflation pressures recommended (while Cold) for the tires originally equipped on your vehicle. These pressure levels must be maintained to assure proper handling, safety and fuel economy.
9. Rear Axle Wheel Configuration: Single or Dual.
10. Serial Number: This is the serial number assigned to the completed vehicle by Winnebago Industries.
11. Vehicle Identification Number (VIN): This number identifies the chassis on which the motor home is built. The 10th digit of the VIN designates the chassis model year. (2=2002, 3=2003). This information is useful when ordering chassis repair parts.
12. Type: States the NHTSA designated usage classification for your motor home. MPV signifies a Multi-purpose Passenger Vehicle.
13. Model: Lists the Winnebago product model number of your vehicle.
14. Color: Signifies the color code number of the decor used throughout the vehicle. This number is necessary for ordering replacement cushions, curtains, carpet, etc.

## EXTERIOR FEATURE IDENTIFICATION

Actual locations of features depends on coach model and options.

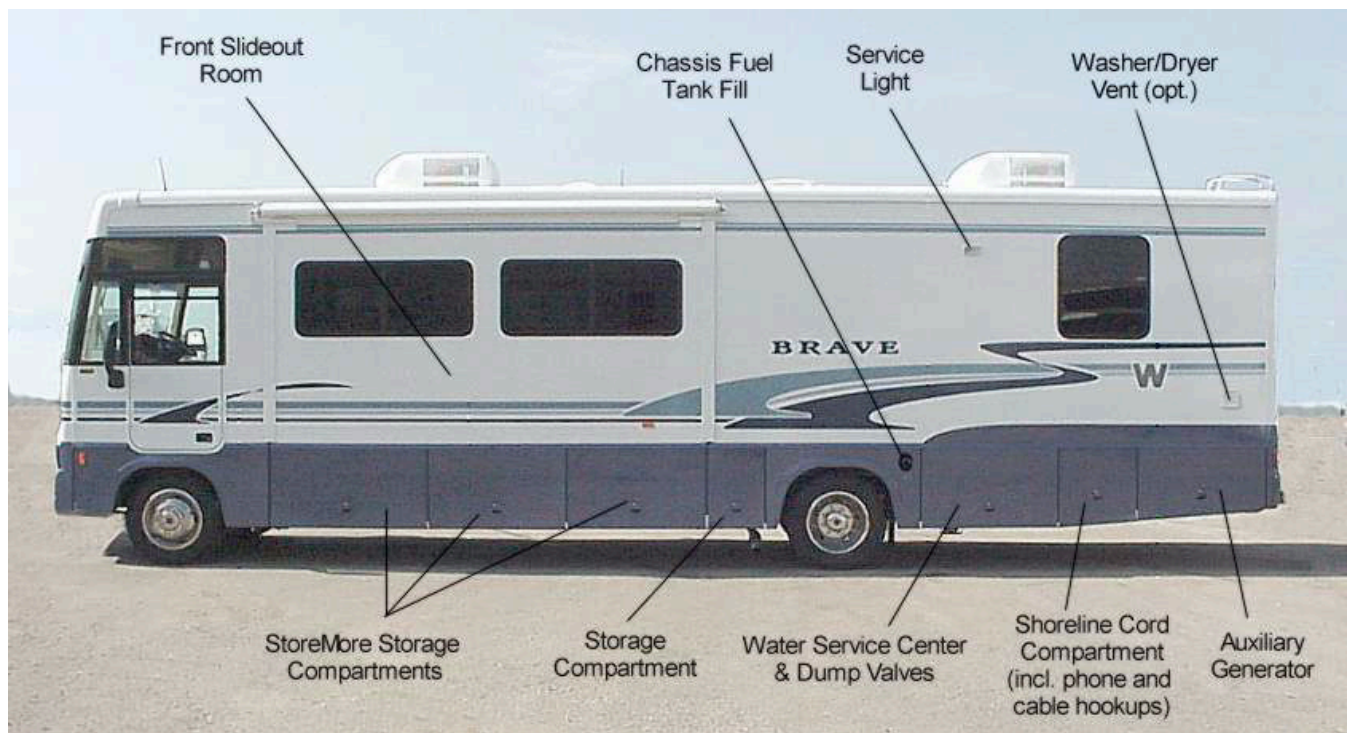
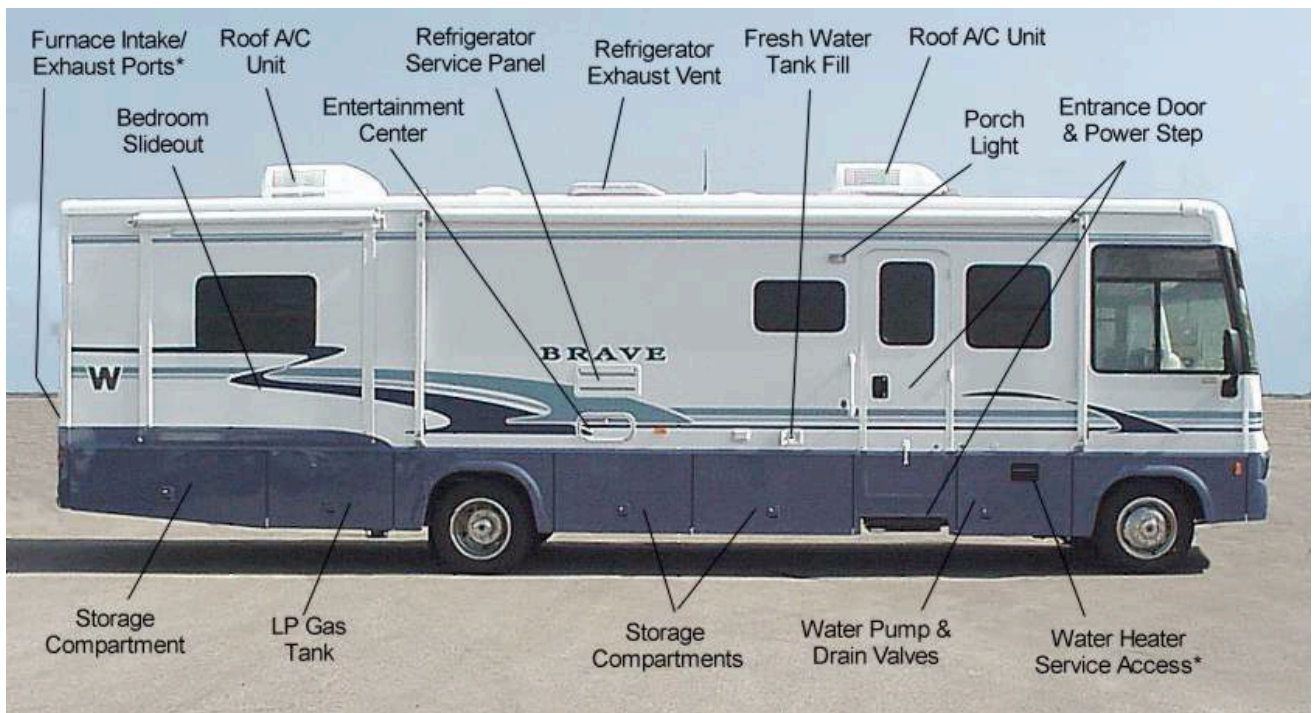

NOTE: Some equipment shown may be optional.







Read and understand all instructions and precautions in this manual before operating your new motor home.

### About Safety Messages Used in This Manual

Throughout this manual, certain items are labeled Note, Caution, Warning or Danger. These terms alert you to precautions that may involved damage to your vehicle or a risk to your personal safety. Read and follow them carefully.



This SAFETY ALERT SYMBOL is used to draw your attention to issues which could involved potential personal injury. This symbol is used throughout this manual and/or on labels affixed on or near various equipment in this motor home.



### DANGER

DANGER indicates a directly hazardous situation which, if not avoided, will result in death or serious personal injury.



### WARNING

WARNING indicates a potentially hazardous situation which, if not avoided, could result in death or serious personal injury.



### CAUTION

CAUTION indicates a potentially hazardous situation which, if not avoided, could result in damage mainly to equipment or property, but in some cases may also result in minor or moderate personal injury.

*NOTE: A 'Note' is not necessarily safety related but indicates a recommendation or special point of information that could assist in understanding the use or care of a feature item.*

The following pages provide safety precautions that must be adhered to. These precautions as well as others that involve possible injury or damage to equipment are also displayed in the appropriate areas in this manual.



### GENERAL WARNINGS

- Only seats equipped with seat belts are to be occupied while the vehicle is moving.
- Make sure all passengers have seat belts fastened in a low and snug position so the force exerted by the belt in a collision will be spread across the strong hip area. Pregnant women should wear a lap-shoulder belt whenever possible, with the lap belt portion worn low and snug throughout the pregnancy.
- All movable or swiveling seats should be placed and locked in forward facing positions while the vehicle is moving.
- Never let passengers stand or kneel on seats while the vehicle is moving.
- Sleeping facilities are not to be utilized while vehicle is moving.
- Examine the escape window and be familiar with its operation, but do not use except in an emergency.
- Inspect the fire extinguisher monthly for proper charge and operating condition. This should also be done before beginning a vacation or any extended trip.



## SECTION 1 SAFETY PRECAUTIONS

# BR AVE



### DRIVING

- Do not attempt to adjust the driver's seat while the vehicle is moving.
- Do not adjust tilt steering in a moving vehicle.
- Do not operate the cruise control on icy or extremely wet roads, winding roads, in heavy traffic, or in any other traffic situation where a constant speed cannot be maintained.
- Use care when accelerating or decelerating on a slippery surface. Abrupt speed changes can cause skidding and loss of control.
- Driving through water deep enough to wet the brakes may affect stopping distance or cause the vehicle to pull to one side. Check brake operation in a safe area to be sure they have not been affected. Never operate any vehicle if a difference in braking efficiency is noticeable.
- Adverse weather conditions and extremes in terrain may affect handling and/or performance of your vehicle. Refer to your chassis manual for related information.



### FUEL & LP GAS



- All pilot lights must be extinguished and appliances turned off while refilling the fuel tank or LP tank.
- Never smoke while refilling vehicle fuel tank or LP gas tank.
- Avoid inhaling exhaust gases produced by burned gasoline, diesel fuel or LP gas in items such as the range, chassis engine, generator engine, refrigerator, furnace and water heater. They contain carbon monoxide, which is an odorless, colorless and poisonous gas.
- Do not bring or store LP gas containers, gasoline or other flammable liquids inside the vehicle because a fire or explosion may result. LP gas containers are equipped with safety valves which relieve excessive pressure by discharging gas to the atmosphere.
- Do not fill LP gas container(s) above 80 percent of capacity. Overfilling the LP gas container can result in uncontrolled gas flow which can cause fire or explosion. A properly filled container will contain approximately 80 percent of its volume as liquid LP gas.
- Never use an open flame to test for LP gas leaks. Replace all protective covers and caps on LP system after filling. Make sure valve is closed and door latched securely.
- Never connect natural gas to the LP gas system.
- When lighting range burners do not turn burner controls to "On" and allow gas to escape before lighting match.
- Portable fuel-burning equipment, including wood and charcoal grills and stoves, shall not be used inside the recreational vehicle. The use of this equipment inside the recreational vehicle may cause fires or asphyxiation.
- LP gas regulators must always be installed with the diaphragm vent facing downward. Regulators are equipped with a protective cover. Make sure that the regulator vent faces downward and that the cover is kept in place to minimize vent blockage which could result in excessive gas pressure causing fire or explosion.
- The following warning label is located in the cooking area to remind you to provide an adequate supply of fresh air for combustion.



### **⚠ WARNING**

IT IS NOT SAFE TO USE  
COOKING APPLIANCES  
FOR COMFORT HEATING

Cooking appliances need fresh air for safe operation. Before operation

1. Open overhead vent or turn on exhaust fan.
2. Open window

FAILURE TO COMPLY COULD RESULT IN  
DEATH OR SERIOUS INJURY.

Unlike large homes, the oxygen supply inside a recreational vehicle is limited due to its size. To avoid danger of asphyxiation, provide proper ventilation when using the gas rangetop or gas oven. It is especially important that the gas oven and range top not be used for comfort heating. Danger of asphyxiation is greater when these appliances are used for long periods of time.

LP gas is present inside the coach. Because LP gas is heavier than air, the detector is located on a cabinet face near the floor of the coach.

A green light on the face of the alarm shows when the unit is active.



LP Gas Alarm



## LP GAS LEAKS

The following label is located in the vehicle near the range area. If you smell gas within the vehicle, quickly and carefully perform the procedures listed.

### **⚠ DANGER** **IF YOU SMELL GAS**

1. EXTINGUISH ANY OPEN FLAME, PILOT LIGHTS AND ALL SMOKING MATERIALS.
2. DO NOT TOUCH ELECTRICAL SWITCHES.
3. SHUT OFF THE GAS SUPPLY AT THE TANK VALVE(S) OR GAS SUPPLY CONNECTIONS.
4. OPEN DOORS AND OTHER VENTILATING OPENINGS.
5. LEAVE THE AREA UNTIL ODOR CLEARS.
6. HAVE THE GAS SYSTEM CHECKED AND LEAKAGE SOURCE CORRECTED BEFORE USING AGAIN.

FAILURE TO COMPLY COULD RESULT IN  
EXPLOSION RESULTING IN DEATH OR  
SERIOUS INJURY.



## LP GAS ALARM

Your coach is equipped with an LP gas detector which sounds an alarm if an unsafe amount of

If the detector senses LP gas, the alarm will make a loud, pulsating sound and the red light will come on. Pressing the "MUTE" button will stop the alarm for 60 seconds. If there is no more detectable LP gas, the alarm will stay off. If the detector still senses LP gas by the end of the 60 second mute mode, the alarm will sound again.

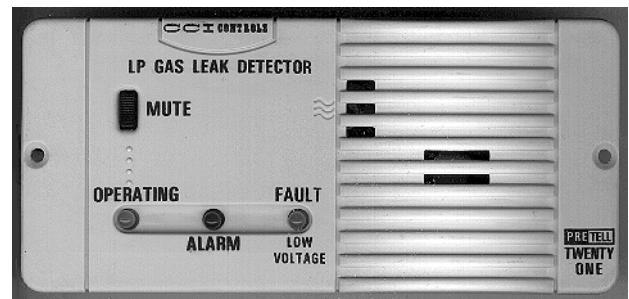

### **If The Alarm Sounds**

If the alarm sounds, do not touch any electrical switches. Immediately turn off the main LP tank valve and all LP appliances, open all windows and roof vents, and leave the coach until the alarm stops sounding.

If the alarm keeps sounding at regular intervals, a leak may be present. Contact your dealer



## SECTION 1 SAFETY PRECAUTIONS

# BR AVE

or an LP gas service center to have the problem corrected before using the LP system again.



### WARNING

Never use an open flame to test for gas leaks. When testing for gas line leaks with a soapy water solution, DO NOT use a detergent containing ammonia or chlorine. These substances may generate a chemical reaction causing corrosion to gas lines, resulting in dangerous leak conditions.

### Power Connection

The gas alarm is powered by the coach batteries. If the auxiliary battery switch is shut off or the battery cable is disconnected from the batteries, the alarm will not work. The LP gas alarm circuit breaker or fuse is located on the 12-volt house electrical load center (breaker panel).



110-Volt Load Center

Because the LP gas alarm is connected directly to the auxiliary battery, it is always drawing a small amount of current. Even though this current draw is slight, it could drain the coach battery during storage periods of 30 days or longer. We recommend turning the auxiliary battery switch off or disconnecting the battery cables from the auxiliary battery during extended storage periods to avoid discharge.

If the coach batteries become extremely drained (8.5 volts or less), the amber Low Voltage/FAULT light on the face of the alarm

will come on, and in some rare cases the LP alarm may begin to sound on its own. This condition is not likely to occur except during storage situations when coach battery charge is not being restored by the converter charger.

### Other Combustible Fumes or Vapors

This alarm is designed to detect the presence of LP gas, however there are other combustible fumes or vapors which may be detected by the sensor. These include: alcohol, liquor, deodorants, colognes, perfumes, wine, adhesives, lacquer, kerosene, gasoline, glues, most all cleaning agents and the propellants of aerosol cans. Most are lighter than air in their vapor state and will only be detected when the area is closed up. Glues and adhesives may exhaust hydrocarbon vapors for months after they are applied. They are easily activated by high temperatures. If you close up an RV coach on a hot day, the chemicals used in its construction may be detected for months after the coach was manufactured.

### Further Information

See the manufacturer's information entitled "Your LP Gas Detector" in the Owner InfoCase for further instructions on nuisance alarms and care and testing of the LP gas detector.



### ELECTRICAL

- Careless handling of electrical components can be fatal. Never touch or use electrical components or appliances while feet are bare, while hands are wet, or while standing in water or on wet ground.
- Improper grounding of the vehicle can cause personal injury. Do not plug the utility power cord into an outlet which is not grounded and do not adapt the plug to connect to a receptacle for which it is not designed.
- Do not attach an extension cord to the utility power cord.
- Be sure that all electrical appliances to be used contain 3-prong plugs for proper grounding.



- Avoid overloading electrical circuits. Replace fuses or circuit breakers with those of the same size and amperage rating only. Never use a higher rated fuse or breaker.
- Use caution when handling or working near electrical storage batteries. Always remove jewelry and wear protective clothing and eye covering. Avoid creating sparks.

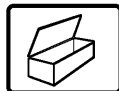

## LOADING

- Store or secure all loose items inside the motor home before traveling. Possible overlooked items such as canned goods or small appliances on the countertop, cooking pans on the range, or free-standing furniture items can become dangerous projectiles during a sudden stop.
- Be aware of GVWR, GAWR and individual load limit on each tire or set of duals. (See “Loading the Vehicle” in Section 4.)
- Never load the motor home in excess of the gross vehicle weight rating or the gross axle weight rating for either axle.

**NOTE:** *Your motor home’s load capacity is designated by weight, not by volume, so you cannot necessarily use all available space when loading your motor home.*



## MAINTENANCE

- Do not remove the radiator cap while engine and radiator are still hot. Always check coolant level visually at the see-through coolant reservoir.
- Never get beneath a vehicle that is held up by a jack only.
- Do not mix different construction types of tires on the vehicle such as radial, bias or belted tires, as vehicle handling may be affected. Replace tires with exact size, type and load range.
- Do not attempt to start the vehicle by hot wiring.

## FORMALDEHYDE INFORMATION

### **WARNING**

Some components in this vehicle contain formaldehyde based adhesives which may release formaldehyde fumes into the air for an unknown period of time until total dissipation occurs. Individuals who are allergic to formaldehyde gas fumes may experience irritation to eyes, ears, nose and throat. Reaction in infants may be more severe. Although long range effects are not well understood, testing to date has not revealed any serious health effects in humans at the level of emission from these products.

**NOTE:** *To aid in dissipation, ventilate the vehicle by opening all windows and circulating the air with a fan.*

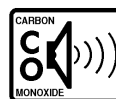

## CARBON MONOXIDE WARNING

### **WARNING**

Avoid inhaling exhaust gases, as they contain carbon monoxide, which is a colorless, odorless and poisonous gas.

If you suspect that exhaust fumes are entering the passenger compartment, have the cause determined and corrected as soon as possible. If you must drive under these conditions, drive only with **ALL WINDOWS FULLY OPENED**.

The best protection against carbon monoxide entry into the vehicle body is a properly maintained engine exhaust and ventilation system. It is recommended that the exhaust system and body be inspected by a qualified motor home service center.



## SECTION 1 SAFETY PRECAUTIONS

# BR AVE

- Each time the vehicle is raised for an oil change.
- Whenever a change in the sound of the exhaust system is noticed.
- Whenever the exhaust system, underbody or rear of the vehicle is damaged.

To allow proper operation of the vehicle's ventilation system, keep front ventilation inlet grill clear of snow, leaves or other obstructions at all times. **DO NOT OCCUPY A PARKED VEHICLE WITH ENGINE RUNNING FOR AN EXTENDED PERIOD.**

Do not run engine in confined areas, such as a garage, except to move vehicle in or out of area. When vehicle is stopped in an UNCONFINED area with the engine running for any more than a short period, adjust heating or cooling system to force outside air into the vehicle as follows:

1. Set fan to medium or high speed and vent control to air.
2. On vehicles equipped with air conditioning, set fan to medium or high speed and set control to obtain maximum vent air.

Rear windows should be closed while driving to avoid drawing dangerous exhaust gases into the vehicle.

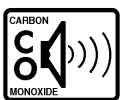

## CARBON MONOXIDE ALARM

Your coach is equipped with a carbon monoxide (CO) alarm located on the ceiling in the bedroom area. The CO alarm is powered by a 9-volt battery and has a sensor that is designed to detect toxic carbon monoxide gas fumes resulting from incomplete combustion of fuel. It will detect CO gas from any combustion source such as the furnace, gas range/oven, water heater, refrigerator, chassis engine, and electric generator engine.



Carbon Monoxide Alarm

### Monthly Testing

Press the TEST button on the face of the alarm periodically (at least monthly) to check the function of the alarm and condition of the battery. If the alarm begins to beep every few seconds, the battery may be weak and need replacement. (Press the TEST button to be sure before replacing the battery. If the alarm sounds, the battery may still be okay. If the alarm still beeps every few seconds, check the smoke detector also. The "low battery" warning beep is similar on many alarm devices, so the origin of this electronic sound can be deceiving.)

### Further Information

Please read the information provided by the manufacturer, which is included in your Owner InfoCase. It includes information on precautions, operational testing, and battery/sensor replacement.



## EMERGENCY EXITS Pop-Out Rear Escape Window

Your motor home is equipped with an emergency exit window in the rear of the vehicle which functions as an escape exit in an emergency situation.

To open, pull on the red plastic loop at the bottom of the window until the rubber cord is completely removed. This allows the window to be pushed out.

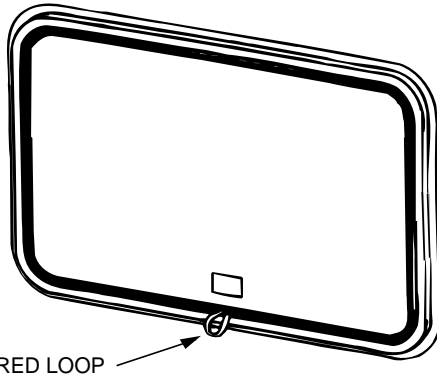

Instructions for removal are also located on a label on the glass for quick reference and for passengers who may not be familiar with the exit. Never removed or destroy this label.

**WARNING**

Use emergency window for emergency exit only. Do not test for proper operation.

If the cord is released by accident, but the glass remains in place, the cord can be replaced using a blunt instrument, preferably one made of plastic. We suggest you contact your dealer for assistance.

**WARNING**

Use care when exiting emergency window, as broken glass may be present in the exit area.

## Swing-Out Rear Escape Window (Optional Thermal Glass)

The rear thermal glass escape window is secured by two red safety latches at the bottom of the window.

To open, lift both latches up and toward the center of the window, then push outward near the bottom of the window.

Instructions for opening are also located near the latches for quick reference and for passengers who may not be familiar with the exit. Never remove or destroy this label.



Lift latch handles upward to open.

## Thermal Rear Escape Window

**WARNING**

This window should be kept closed while driving to avoid drawing dangerous exhaust gases into the vehicle.

## Using Slider Windows As Emergency Exits

Most slider windows along the side of the motor home can also be used as emergency exits, should the need arise. To use the windows as exits, first slide the window open, then slide the screen open.



## FIRE EXTINGUISHER

A dry chemical fire extinguisher is located near the floor by the side entrance door.





## SECTION 1 SAFETY PRECAUTIONS

# BR AVE

We recommend that you become thoroughly familiar with the operating instructions displayed on the side of the fire extinguisher or in the information supplied in your Motor Home Operations Manual binder.

We also recommend that you inspect the fire extinguisher for proper charge at least once a month in accordance with National Fire Protection Association (NFPA) recommendations as stated on the label.

If the charge is insufficient, the fire extinguisher must be replaced.



### WARNING

Do not test the fire extinguisher by discharging it. Partial discharge can cause leakage of pressure or contents which would render the unit inoperative when needed. When using the fire extinguisher, aim the spray at the base of the fire.



### SMOKE ALARM

Your motor home is equipped with a smoke alarm located on the ceiling in the galley area. This alarm meets U.L. Standard 217 and NFPA Standard 74 for operation of smoke detection devices.

1. The smoke alarm should be tested for correct operation each time the vehicle is brought out of storage, before each trip, and at least once a week during motor home use. To test the electronics, firmly depress the button. To test that smoke reaches the sensor, blow smoke in a careful, fire-safe manner into your smoke alarm.

Press button to test

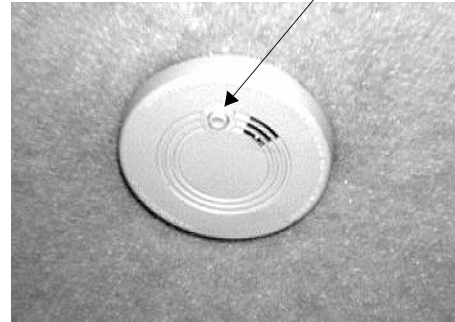

Smoke Alarm

2. Your smoke alarm will not work without power. Never remove the battery to quiet the alarm. When your smoke alarm “beeps” about once a minute the battery is weak. Install a new battery immediately. Be sure to use only batteries specified in manual or on unit. Test unit after installing a new battery.
3. Clean and vacuum the openings on your smoke alarm once a month.
4. Do not open the smoke alarm or try to repair it. For replacement information see warranty in Owner’s Manual.
5. Smoke alarms have technical limitations and may not respond in all situations. FIRE PREVENTION is your best safeguard.

See your Owner Infocase for further information.



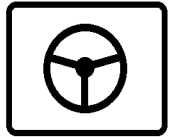

(See also Safety Precautions, Section 1 of this manual.)

*NOTE: See your Ford or Workhorse chassis operator's guide for information on starting the engine, operating the transmission, steering column controls descriptions of instrument gauges and other chassis related information.*

*Some items described in this section may be optional or unavailable on your coach.*



### BEFORE ENTERING YOUR VEHICLE

Before entering your vehicle, there are a few recommended procedures that will aid in your driving safety and equipment.

1. Be sure that the windows, mirrors and light lenses are clean and unobstructed.
2. Make sure all exterior lights operate properly.
3. Check tires for proper cold inflation pressures and inspect for any unusual wear.
4. Check wheel lug nuts for tightness.
5. Look beneath the vehicle for noticeable fluid leakage.
6. Check fluid levels and fill if necessary. This includes engine oil, transmission fluid, coolant, brake fluid, power steering fluid and windshield washer solvent.

 **WARNING**

The engine should be shut off unless specifically required for a certain procedure.

Transmission must be in P (Park) and park brake applied while performing any checks or adjustments.

7. Unhook and store sewer and water supply hoses.
8. Retract step.
9. Be sure that all of your cargo is secured in event of a sudden stop or an accident.
10. Check around your vehicle in all directions to assure that you have proper clearance.
11. Lower TV antenna and/or satellite dish.
12. Disconnect and store shoreline.

 **WARNING**

Before driving your vehicle, be sure you have read the entire operator's manual and that you understand your vehicle's equipment completely and how to use the equipment safely.



### BEFORE DRIVING YOUR VEHICLE

Before preparing to drive your vehicle, here are a few recommended procedures that will add to your driving safety and comfort.

1. Be sure that you adjust the interior and exterior rear view mirrors to your driving preference.
2. Adjust the driver's seat for proper distance from foot pedals and steering wheel to allow for safety and ease in controlling your vehicle.



3. Place front seats in the forward facing position.
4. Be sure to fasten all safety belts to fit you comfortably, but tight enough to obtain the full safety of the belts.
5. Make sure all doors are completely shut and locked. When the doors are shut and locked, there is less chance of the doors flying open in event of an accident. It also prevents unintentional opening of doors and keeps intruders out of your vehicle.
6. Check to see that all gauges are operating properly.
7. Check the fuel level in the vehicle.
8. Be certain that the fire extinguisher is fully charged and secure in its mounting bracket.

|  |                |
|--|----------------|
|   | <b>CAUTION</b> |
| Be sure hood and all compartment doors are latched securely before driving vehicle |                |

|  |                |
|--|----------------|
|    | <b>WARNING</b> |
| Modern fuel systems may build up pressure within the tank as the gasoline warms during use or in hot weather.  |                |
| Under certain conditions, sudden release of this pressure when removing the gasoline cap can spray gasoline from the fuel fill opening, causing a possible hazard. |                |

**GASOLINE FUEL FILL**

**REMOVING THE FUEL CAP**

When removing the gasoline cap, slowly rotate it **only far enough to allow pressure to release**. After any "hissing" sounds stop, continue removing the cap.

**FILLING THE TANK**

**Do not overfill the fuel tank.** Allow gasoline to pump into the tank until the auto-shutoff valve in the fuel pump nozzle stops the flow of fuel, indicating a full tank. This provides a pre-determined vapor space at the top of the tank to allow for expansion of the gasoline.

|   |                |
|---|----------------|
|           | <b>CAUTION</b> |
| Continuing to fill above this level may cause damage to the fuel/evaporative emission system. |                |



**KEYS**

Your motor home is supplied with several sets of keys. In addition to the chassis manufacturer's ignition key, you receive keys for the entrance door and exterior compartment doors.

Each set of keys has an identification number, either a small metal tag or stamped into the key head. Record these numbers and keep them in a safe place. In case keys are lost or stolen, your dealer or a locksmith can provide you with duplicate keys or modify the locks.

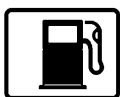

**FUEL SELECTION**

Refer to your chassis operating guide for the manufacturer's recommendations on proper fuel selection.



**Chassis Fuel Tank ..... 75 gal.**



## REPLACEMENT FUEL CAPS

To protect gasoline system from excessive pressure or vacuum, or from sudden pressure, replace lost caps with caps of the same design available from your dealer.

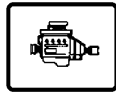

## STARTING AND STOPPING ENGINE

Refer to your chassis operating guide for the manufacturer's recommendations on starting and stopping the engine.

### Brake-Shift Interlock (Workhorse Chassis)

Workhorse chassis are equipped with a brake-shift interlock safety feature. The shift lever cannot be moved from the Park position unless the ignition is ON and the service brake pedal is pressed.



## PARKING BRAKES

27 ft. Models on Workhorse Chassis  
30 ft. & 33 ft. Models on Ford Chassis

The parking brake pedal is located to the left of the service brake pedal.

To set the parking brake, press the service brake pedal firmly with your right foot while you apply the parking brake with your left foot. The BRAKE warning light will go on as soon as you start to press the parking brake pedal. The brake will not prevent the vehicle from moving unless you push it down firmly and fully. Remove your foot from the service brake pedal and make sure there is no vehicle movement.

To release the parking brake, apply the service brake with your right foot and hold the parking brake pedal down with your left foot while you pull the release lever. The release lever is located above the brake pedal.

Never drive your vehicle with the parking brake set as this will reduce parking brake effectiveness and cause excessive wear.

### PARKING BRAKE (30 ft. & 33 ft. Models on Workhorse Chassis)

This chassis is equipped with an automatically applied parking brake that actuates when the shift lever is moved to the Park position.

*NOTE: Parking brakes may also be applied by pulling outward on a large, diamond-shaped knob on the dash to the right of the steering column. Push the knob in to release the parking brakes.*



## HAZARD WARNING LIGHTS

See chassis manual or "Instrument Panels" in this section for location of hazard flasher switch. See also Section 3 for further operating information.



## ENTRANCE DOOR LOCK AND HANDLE

The entrance door may be opened by pulling the door handle outward. When the door is locked, neither the inside nor the outside door handle can be operated. It can be locked and unlocked from the outside of the vehicle by inserting the key into the lock and turning.

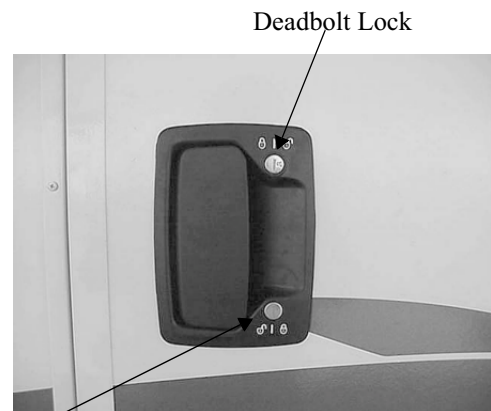

Door Lock

Entrance Door Handle - Outside

To lock the door from inside, rotate the lock levers as indicated. The deadbolt lock is for added security and should be used as a security night lock.

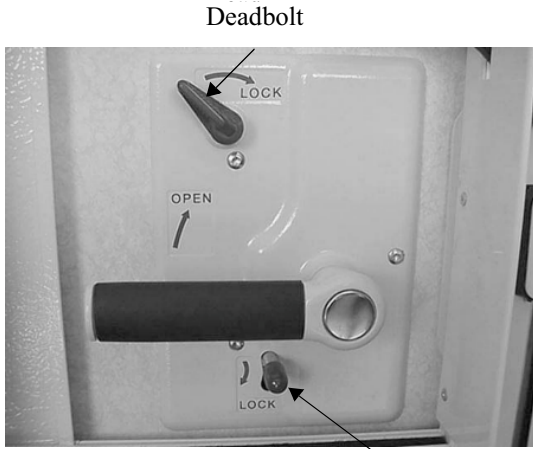

Deadbolt

Door Handle Lock

Entrance Door Handle - Inside

Press lever to separate screen door from main entrance door



Screen Door Latch - Inside

Lubricate the locks periodically with graphite to maintain good working condition.

**CAUTION**

When releasing security night lock, be sure to retract bolt before opening door latch to prevent drag on bolt pin. Instruct all passengers in operation of this door catch system as well as emergency exit window.

*NOTE: Keys should always be removed when leaving the vehicle. Since doors can be locked without keys, make sure they have been removed from the ignition before locking the driver's compartment.*

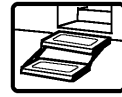

**ELECTRIC ENTRANCE STEP**

The power switch for the electric entrance step is located to the left of the main entry door as you enter the coach.



**Automatic Mode (Operates with Door)**

With the Power Switch in the On position the step is in Automatic Mode. This means it will extend and retract automatically whenever the door is opened or closed. This is done by means of a magnetic door switch attached to the lower hinged edge of the screen door section of the entrance doors. The steps will extend when the screen door is opened, and retract when the screen door is closed. With the power switch in the Off position the step can be kept in the extended or retracted position as described below.

**Stationary Extended Mode**

To keep the step in the extended position:

- turn the Power Switch to **On**,
- **open** the screen door to extend the step,
- then turn the Power Switch to **Off**.

The step will now stay extended whether the door is opened or closed. This position is normally used when parked at a campsite or whenever people are going to be entering and exiting the vehicle frequently.



## Stationary Retracted Mode

To keep the step in the retracted position:

- turn the Power Switch to **On**,
- **close** the screen door to extend the step,
- then turn the Power Switch to **Off**.

The step will now stay retracted when the screen door is open or closed. This position is normally used where an exterior step is not required or to avoid damage to the setp, such as when parked near a high curb or similar object.

## Automatic Retraction Feature

The coach is equipped with a step retraction feature that retracts the step automatically when the Ignition Switch key is turned to either the On or Start position regardless of whether the Step Power Switch is On or Off. This feature is standard and is installed to prevent injury or damage which may be caused by an extended step when the vehicle is moving. An associated feature is the “Last Out Feature”. This feature extends the step when the screen door is opened after the ignition switch has been turned to either the On or Start position.

### **WARNING**

Do not use steps unless it is fully extended.

Do Not Stand on step when vehicles ignition switch is turned to either the “On” or “Start” position. The step will automatically retract, which may cause personal injury. Always remember to retract the step before moving the vehicle.

For additional information on the step, see the step manufacturer’s operators manual included in your Owners *InfoCase*.



## SEATS

The driver and co-pilot seats may be independently adjusted to suit individual preference. To move the seat forward or backward, lift the slide release paddle, located on the side of the seat, and exert slight body pressure in the direction desired.

The seats may be swiveled to provide easy entrance and exit. The swivel feature also allows the seats on some models to be turned toward the living area for additional seating while the unit is parked.

To swivel the seats: Lift the release lever, located on the side of the seat, and rotate seat. The seats are designed to lock only when returned to the forward facing position.

To recline the seats: Lift the reclining lever, lean back to desired incline and release the lever. To return to the upright position, lift the lever and lean body forward. Allow the seat to return to the desired position and release the lever.

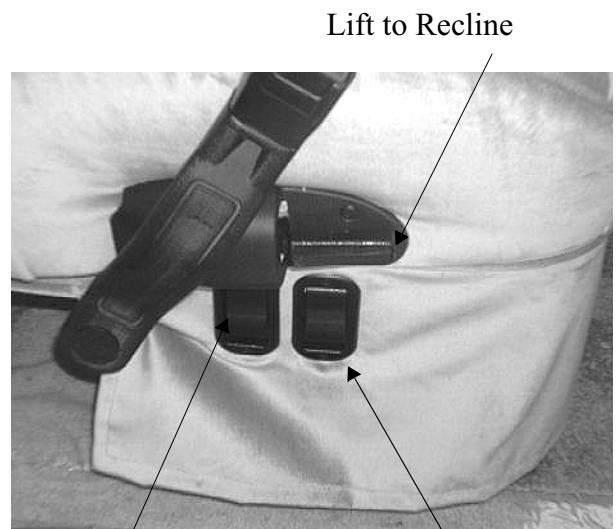

Lift to Swivel

Lift to Slide

Driver Seat - Aisle Side



Lift to Slide

Lift to Swivel



Passenger Seat - Aisle Side  
(Recline lever on opposite side)

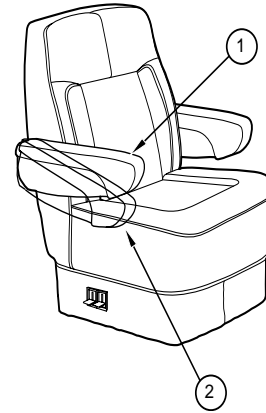

**SEAT BELTS**

Seats intended for occupancy while the vehicle is in motion are equipped with seat belts for the protection of the driver and passengers.

**Lap Belts**

The lap belts must be worn as low as possible and fit snugly across the hip area. Always sit erect and well back into the seat. To gain full protection of the safety belt, never let more than one person use the same safety belt at any one time, and do not let the safety belts become damaged by pinching them in the doors or in the seat mechanism. After any serious accident, any seat belts which were in use at the time should be replaced.

**⚠ WARNING**

Do not adjust driver's seat while vehicle is in motion.

After adjusting seat, always use body pressure to make sure slide and swivel locking mechanism have engaged.

**ARM REST ADJUSTMENT**

The driver and co-pilot seat armrests may be adjusted to rest at two different positions as shown.

Position 1 - Raise armrest, push in toward seat, and lower into position. This position would generally be used when the seat is in the upright position.

Position 2 - Raise armrest, pull outward from seat, and lower into position. You may wish to use this position when you recline the seat.

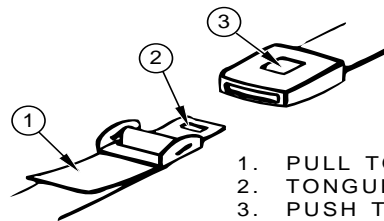

1. PULL TO TIGHTEN.
2. TONGUE.
3. PUSH TO RELEASE.

**Adjustment:** To lengthen belt, turn tongue at a right angle to belt and pull to desired length. To shorten, pull loose end of belt.

**To Fasten:** Be sure belt is not twisted. Grasp each part of the belt assembly and push tongue into buckle. Adjust to a snug fit by pulling the loose end away from the tongue.



**To Release:** Press button in center of buckle and slide tongue out of buckle.

 **WARNING**

Snug and low belt positions are essential. This will ensure that the force exerted by the lap belt in a collision is spread over the strong hip area and not across the abdomen, which could result in serious injury.

Only seats equipped with seat belts are to be occupied while vehicle is in motion.

### Lap-Shoulder Belts

**Fastening:** Hold the belt just behind the tongue using the hand nearest to the door. Next, bring the belt across the body and slide the tongue into the buckle until the latch engages.

**Unfastening:** Press the release button in the buckle. Hold onto the tongue when you release it from the buckle to keep it from retracting too rapidly.

When the lap-shoulder belt is in use, the lap portion must ride across the strong hip area and the shoulder portion must ride diagonally over the shoulder blade toward the buckle.

The shoulder belt is designed to lock only during a sudden stop, sudden body movement or a collision. At all other times it will move freely with the occupant.

 **WARNING**

Never wear the shoulder belt in any position other than as stated above. Failure to do so could increase the chance or extent of injury in a collision

### Seat Belt Care and Cleaning

- Be careful not to damage the belt webbing and hardware. Take care not to pinch them in the seat or doors.
- Inspect the belts and hardware periodically. Check for cuts, frays, and loose parts. Dam-

aged parts should be replaced. Do not remove or modify the belt system.

- Keep belts clean and dry. If the belts need cleaning, use only a mild soap and water solution. Do not use hot water. Do not use abrasive cleaners or bleach. These products may weaken or damage the belts.
- Replace any belt assembly that was used during a severe impact. Replace the complete assembly even if damage is not apparent.



### CHILD RESTRAINTS

All 50 of the United States and the District of Columbia now require the use of the child/infant restraint systems for children in vehicles.

A properly installed and secured child restraint system can help reduce the chance or severity of personal injury to a child in an accident or during a sudden maneuver. Children may be injured in an accident if they are not seated in a child restraint which is not properly secured.

A child restraint system is designed to be secured in a vehicle seat by a lap belt or the lap belt portion of a lap-shoulder belt. According to accident statistics, children are also safer when properly restrained in rear seating positions than in front seating positions.

When purchasing a child restraint system:

1. Look for the label certifying that it meets all applicable U.S. Federal Motor Vehicle Safety Standards (FMVSS) or, in Canada, requirements of the Children's Car Seats and Harnesses Regulations (CCSHR).
2. Make sure that it will attach to your vehicle and restrain your child securely and conveniently so that you are able to install it correctly each time it is used.
3. Be certain that it is appropriate for the child's height, weight and development. The instructions and/or the regulation label attached to the restraint typically provides this information.
4. Review the instructions for installation and use of the restraint. Be sure that you understand them fully and can install the restraint properly and safely in your vehicle.



**MIRRORS**

Always adjust mirrors for maximum rear visibility before driving off. Make sure the seat is adjusted for proper vehicle control and that you are sitting back squarely into the seat.

**Power Electric Mirrors**

The electric mirrors are adjusted using a multi-directional switch located on the dash to the right of the steering column.

Select the mirror to be adjusted by pushing the switch in the middle of the control to the right or left. Then press the arrow buttons as necessary to obtain the best view.

When mirrors are adjusted to preference, place the selector switch back in the middle position to cancel power to the buttons. This prevents accidental misadjustment of mirror settings.

The mirrors also contain heating elements to defog or de-ice the mirror glass during cold weather operation. An ON-OFF switch for the mirror heaters is located near the remote mirror controls.



Mirror Heat Switch

Mirror Adjustment Control

The power mirror control switch is intended for fine adjustment of the mirrors. If you cannot adjust the mirror properly using the control switch, the mirror may need a coarse adjustment by repositioning the mirror head. See the mirror manufacturer's instructions in your Owner InfoCase.



**More Info** - To read more about power mirrors, see the mirror manufacturer's information in your Owner InfoCase.



**RV Radio™**

The RV Radio™ in your coach can receive AM/FM stereo and Weather band stations. It also has both cassette and compact disc (CD) players for your listening enjoyment through quality high-output speakers located in several areas of the coach.



**Radio Power Switch**

The radio power switch lets you connect the dash radio to the house batteries with the ignition switch turned off for listening while parked. This prevents accidental draining of the chassis (starting) battery during prolonged operation of the radio.

**Deluxe Sound System (Optional)**

Your coach may be optionally equipped with a deluxe sound system featuring special high-output cube speakers and subwoofers to enhance your listening enjoyment.

Place the Radio Power Switch in HOUSE position. A speaker selector switch in the front right overhead cabinet (video center) lets you switch the deluxe speakers to your desired sound source, whether the dash radio or the TV and VCR for theater surround sound listening.





Video Center  
(Front Overhead Compartment)



## REARVIEW TV MONITOR SYSTEM - Optional

If your motor home is equipped with this optional system, refer to the Owner InfoCase for specific instructions provided by manufacturer.



## INSTRUMENT PANEL GAUGES AND CONTROLS

The illustrations on the following page showing switches and features provided by Winnebago.

See your chassis owner's manual for detailed information on the instrument gauges, steering column controls, brakes, and other chassis original equipment.



**INSTRUMENT PANEL**



Workhorse instruments shown for illustration purpose only.

NOTE: Some equipment or controls shown may be optional or unavailable on your model.

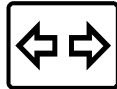

## MULTI-FUNCTION SIGNAL LEVER

The multi-function signal lever controls the turn signals, high/low beam changing, windshield washer, wipers and wiper delay, and the electronic speed control (cruise) on some models.\*

See your chassis operating guide for complete operating information.

\*Ford chassis models have the cruise control system integrated into the steering wheel. See your Ford chassis guide for operating instructions.



## HEADLIGHT BEAM CHANGE AND TURN SIGNALS

Move multi-function lever upward for right turn signal and downward for left turn signal.

Pull end of handle toward you to switch high beam to low, or low beam to high.



## WINDSHIELD WIPERS AND WIPER DELAY

See your chassis operating guide for complete operating information.

## CRUISE CONTROL

The electronic speed control (cruise) allows you to maintain a steady speed and relieve driving strain while traveling long distances.

See your chassis operator manual for complete instructions and precautions on the cruise control.



## WARNING

Do not operate the cruise control on icy or extremely wet roads, winding roads, in heavy traffic, or in any other traffic situation where a constant speed cannot be maintained.

*NOTE: Before leaving on vacation or a long trip, make a short road test to see that all functions are working. If your speed control does not function properly, contact your dealer.*



## COMFORT CONTROLS AUTO AIR CONDITIONER/ HEATER

Controls for the air conditioner, heater, defroster and vent are all combined into one control panel. Refer to the following instructions for use of individual controls.

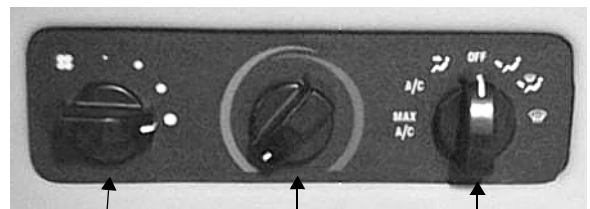

Fan Speed Switch

Temp Control

Mode Selector

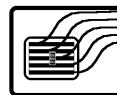

## HEATING

### A. For maximum heating

1. Turn the mode selection knob HEAT or VENT.
2. Turn the temperature control knob to WARM (red).
3. Place the fan switch to high (largest dot).

### B. For reduced heating:

1. Turn the temperature control knob toward the COOL (blue) zone to the desired comfort position.
2. Adjust the fan speed for desired volume.



## DEFROSTING

### A. For maximum defrosting and defogging:

1. Turn the mode control knob to DEF.
2. Turn the temperature control knob to WARM (red).



## SECTION 2 DRIVING YOUR MOTOR HOME

# BR A V E

3. Turn the fan switch to high (largest dot).
4. Turn on auxiliary (dash) fans if additional air movement is needed

### B. For reduced defrosting:

1. Turn the temperature control knob to the left to an intermediate warm setting.
2. Adjust the fan speed for desired volume.

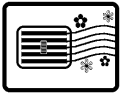

## VENTILATION

### A. To vent outside air into the vehicle when neither heating or cooling is required.

1. Turn the mode selection knob to VENT.
2. Turn the temperature control knob all the way to the left to the COOL (blue) zone.
3. Adjust the fan speed for desired volume.

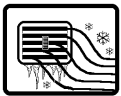

## AIR CONDITIONING

### A. For maximum cooling.

1. Turn the mode selection knob to MAX A/C.
2. Turn the temperature control knob all the way left to the COOL (blue) position.
3. Turn the fan speed switch to high (largest dot).

### OFF

When no heating, cooling or defrosting are required:

1. Turn the mode selection knob to OFF. This will shut off the fan and prevent outside air from entering the unit.

*NOTE: The automotive air conditioner is not designed to cool the entire interior of the motor home, but is intended to cool the driver's compartment only.*



## REAR COACH HEATER

To provide automotive heat to the rear of the vehicle, press the rear heater fan switch to the desired speed.

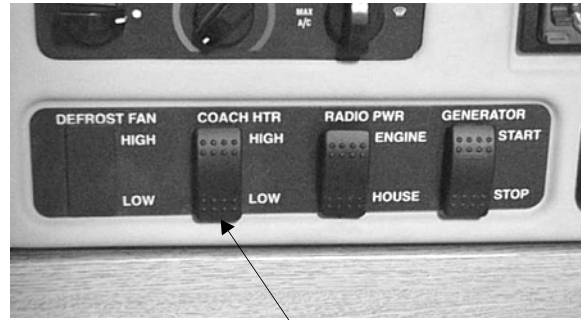

Coach Heater Switch

## BATTERY BOOST SWITCH

This switch can be used to provide emergency starting power from the motor home auxiliary battery if the automotive battery is dead.



Battery Boost Switch

If engine battery is dead, press on and hold while turning ignition key for emergency starting power.

## AUXILIARY BATTERY (Aux. Batt) SWITCH

The AUX BATT switch disconnects the auxiliary (coach) batteries from the 12-volt system of your coach to avoid long-term battery drain by electrical items that are hooked directly to the coach batteries.

Always leave this switch ON except during storage periods.



Aux. Batt. Switch  
(Near entrance door)

The Aux. Batt switch is conveniently located near the entrance steps.

### Passenger Work Station - Optional

Pull the workstation top backward toward you until it latches in the fully extended position. There is a partitioned supply tray molded into the top of the dash beneath the worktop.

To close the workstation, release the catches on both sides of the worktop by pushing upward as shown. Glide the worktop forward until it latches onto the dash top.



## WARNING

Do not use the passenger side front workstation in the extended position while the vehicle is in motion.

### BEVERAGE TRAY - Storage Space

Lifting the hinged top of the beverage tray will reveal room to store several small items.



### COACH LEVELING SYSTEMS

Your coach is equipped with a hydraulic leveling system. The control pad is located on the lower left side of the dash. The leveling system makes selecting a parking site easier and faster by reducing the effect of uneven ground. Remote controlled hydraulic jacks raise the affected low corners of the coach to make leveling “set up” faster and easier for you.

### LEVELING PROCEDURE

**IMPORTANT:** Do not operate the room extension without first leveling and stabilizing the vehicle.

1. Place gear selector in the parking position, apply park brake and block tires securely.

*NOTE: If the hand/auto park brake is not set, the “NOT IN PARK/BRAKE” light will come on when the “ON” button is pushed. The panel will turn on, but the system will not operate.*

2. Turn ignition switch to “ACCESSORY”.
3. Push the “ON” button on the touch panel. The POWER ON light will be lit. Place pads under the jacks, if necessary, at this time.
4. A lit yellow LEVEL light indicates that end, or corner side is low. Move the joystick lever



in the direction needed to extend jack pairs according to lit yellow lights. ALWAYS LEVEL THE VEHICLE FROM SIDE TO SIDE BEFORE LEVELING THE VEHICLE FRONT TO REAR. Only one yellow LEVEL light can be on at one time. Extend jack pairs accordingly until all yellow lights are out. If the ground is too uneven, the jacks may not have enough stroke to level the vehicle. The vehicle may have to be moved or blocking placed under the pads.

5. After the vehicle is level, the jacks not used for leveling should be extended until they touch the ground. The remaining jacks used to stabilize the vehicle should lift the vehicle slightly after touching the ground. This provides additional stability against wind and activity in the vehicle. Do this by pushing the joystick to front and/or rear as needed to extend any remaining jacks. Do not move to the right or left positions.
6. Push the "OFF" button on the touch panel.
7. Turn the ignition switch off.

*NOTE: The leveling system should be cycled once a month or whenever the vehicle is used, to keep the system in operating condition.*

*NOTE: When parking at an uneven site, always park the front of the motor home to the downhill side. This allows you to level by raising the front end rather than the rear. Since only the rear wheels are locked while in PARK, raising the rear wheels off the ground could allow the vehicle to roll off the jacks.*



**! WARNING**

Keep all people clear of the coach while the leveling system is operating.

Do not use the leveling jacks to support vehicle for service or tire changing.

**! CAUTION**

Do not rely only upon the warning lights to indicate when jacks are up. It is the owner's responsibility to check that all jacks are up before moving the coach.

**Further Information**

See the HWH Operator Manual supplied in your Owner InfoCase. It contains detailed instructions, precautions and technical information. It also contains troubleshooting instructions for operating system if any functions fail.

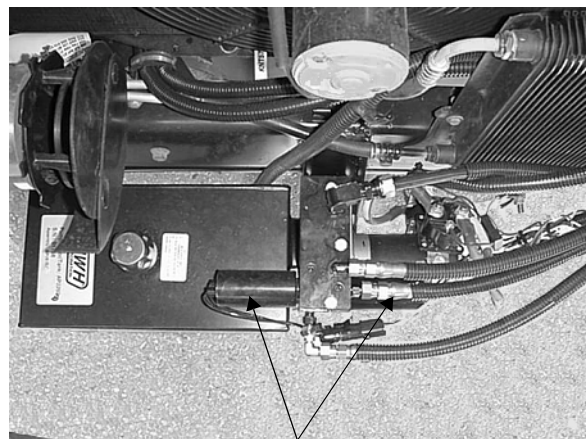

Solenoid Valves

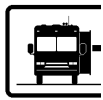

## SLIDEOUT ROOM

The slideout living room provides a spacious living area at the push of a button. The slideout room is extended and retracted using a hydraulic mechanism with an electronic control system. The slideout control switch is located near the leveling system pad on the lower left dash area.



### CAUTION

Release slideout room travel straps before attempting to extend slide-out room. Fasten travel straps before driving vehicle. See instructions below.

### TRAVEL STRAPS

The travel straps **must be released before attempting to extend the room** or damage to the coach will result.

The travel straps are designed only to help keep the room extension secured against the coach sidewall to maintain an effective weather seal while the vehicle is in motion. They are not designed to withstand the force exerted by the hydraulic extension mechanism and will not prevent accidental extension of the room.

The travel straps are located near the floor at the front and/or rear ends of the slideout room.

#### To Release:

- Pull the strap buckle outward and up to release tension on strap.
- Pull a short length of the excess strap back through the buckle to provide sufficient slack.
- Unhook the strap end pegs from the mooring brackets on the floor and wall edge. Store straps in location of your choice. (Under the couch is one choice.)



#### To Fasten Straps:

- Hook the strap end pegs into the mooring brackets.
- Flip buckle downward and press toward strap until it “snaps” snugly into place against the strap.
- If a strap is loose or too tight after closing the buckle, release the buckle and pull the loose end of the strap in or out to adjust tension as needed. Then reclose the buckle.

*NOTE: If straps become loose and will not stay fastened, see your dealer for proper adjustment.*



**! WARNING**

Keep all persons clear of the slideout room and moving parts while extending or retracting. Do not occupy the slideout room while it is being extended or retracted.

**To Extend SlideOut Room:**

**IMPORTANT:** Do not operate the room extension without first leveling and stabilizing the vehicle.

- Level the coach.
- Set the Parking Brake. An interlock relay system will then provide power to the slideout control switch.

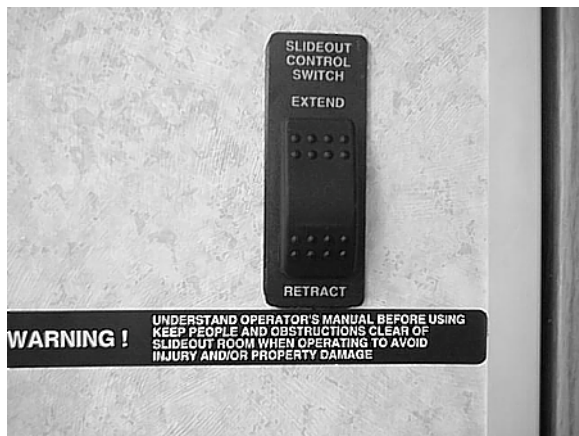

Rear Slideout Switch  
(on wall in rear of coach)

- Press slideout switch and hold until room is fully extended, then release switch.

**To Retract SlideOut Room:**

**! CAUTION**

Although there is an awning over the roof of the slideout room, there is a possibility of debris getting onto the roof. Because the slideout roof is drawn into the interior of the coach when retracted, be sure there is no debris, such as excessive dirt, tree seeds, twigs, leaves, etc. on the roof before retracting.

- Remove all items from the coach living room floor.
- Set the Parking Brake. An interlock relay system will then provide power to the slideout control switch.
- Press slide-out switch and hold until room is fully retracted, then release the switch.

**If SlideOut Room Will Not Operate (Troubleshooting)**

- The chassis battery may be low on charge. Press the Aux. Start switch on the dash to the momentary (MOM) position while pressing the slideout control switch. This momentarily connects the coach batteries to assist in retracting the room.
- One of the fuses may be blown. Fuses are located in the fuse block on the interior firewall beneath the dash, and in the fuse block beneath the instrument panel dash pod.
- If the batteries and fuses are okay, there may be a failure in the hydraulic system or electrical system. See “Emergency Crank-In Procedure” for help.

**Emergency Crank-In Procedure (for use when room will not retract using control switch)**

If a failure occurs in the slideout electrical or hydraulic systems, and the room will not retract





using the control switch, you can manually retract the room using the emergency winch system described below. The winch is stored in a basement storage compartment.

## **WARNING**

Stop engine, place transmission in parking position and apply parking brake before lying beneath vehicle for this procedure.

**DO NOT OPEN ANY OF THE 4 VALVES ON THE OUTBOARD END OF THE PUMP** because they regulate the leveling jacks. If these valves are opened while the leveling jacks are in use, it could cause the vehicle to lower rapidly.

*NOTE: The hydraulic pump solenoids have a small 1/4" nut at the end of the valve shaft that requires you to use a 1/4" nut driver tool that is provided in your Info-Case. DO NOT loosen the shaft more than 4 TURNS or the solenoid will become damaged and need replacement.*

*When closing the valves, tighten snugly, but do not overtighten. Overtightening may cause internal damage to the valves.*

*See the HWH Operator's Manual included in your InfoCase for specific instructions on which valves to open for front or rear slideout rooms and what additional precautions to follow.*

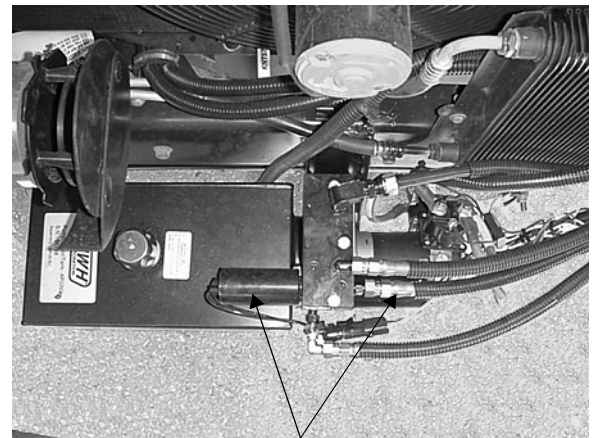

Solenoid Valves

Use provided 1/4" nut drive tool to turn nut open 3 TURNS ONLY

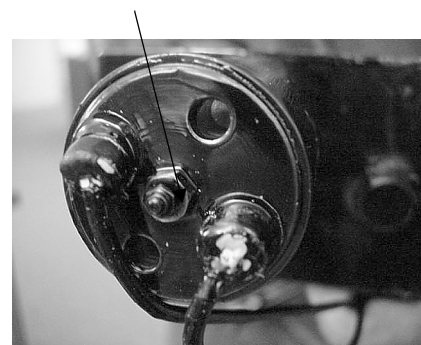

Slideout Room Solenoid Valve

- The hydraulic pump is located between the front frame extensions between the radiator and grille/bumper area.
- Open the two slideout solenoid valves (with 1/4" nuts on the ends) to relieve hydraulic line pressure. (See Step 1 under "Slideout Room Emergency Crank-In" on previous page.) **DO NOT LOOSEN NUTS MORE THAN 4 FULL TURNS.**
- Locate winch mounting straps and insert hook into sewn loop end of strap from beneath couch.
- Attach winch to step floor cutout.

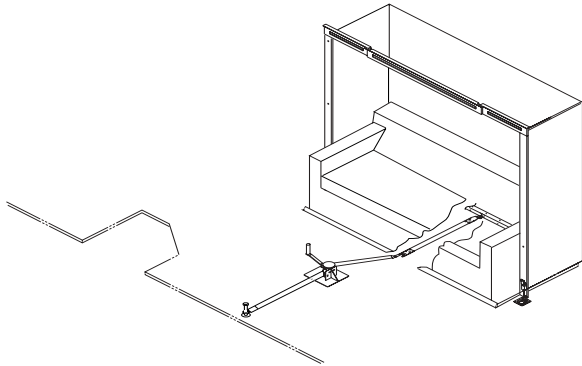

Winch attachment beneath dinette seat

- Guide strap through cutout in aisle side of dinette seat at carpet level. Insert hook into sewn loop end of strap from beneath couch.
- Crank winch handle clockwise slowly, a few “clicks” at a time, until the room is fully retracted. **Allow about 10 minutes to crank room in fully.**

*NOTE: Attempting to crank room in too quickly will raise pressure in hydraulic fluid lines and make cranking more difficult.*

- Leave the retractor winch and strap in place until unit is serviced.
- Fasten travel strap(s) as shown on preceding pages.
- Leave the hydraulic pump valves open.

See your dealer for service of the slideout system before using again.

### **Further Information**

See the HWH Hydraulic Room Extension operating guide included in your Owner’s Info-Case for further instructions and troubleshooting information.



### HAZARD WARNING FLASHER

The hazard warning flasher provides additional safety when the vehicle must be stopped on the side of the roadway and presents a possible hazard to other motorists. When the flasher is on, it serves as a warning to the other drivers to approach and overtake your vehicle with caution.

#### **WARNING**

Operating the hazard warning flasher system while moving on the highway is illegal.

The front directional signals and the taillights will flash intermittently when the flashers are in operation. The hazard warning flashers will not operate when the service brake pedal is depressed. The turn signal will not operate when the flashers are on. When it is necessary to leave the vehicle, the flasher system will continue to operate with the ignition key removed.



### IF YOU GET A FLAT TIRE

In case of sudden tire failure, avoid heavy brake application. Tire manufacturers recommend accelerating briefly to regain steering stability, then gradually decreasing speed. Avoid quick steering movements. Hold the steering wheel firmly and move slowly to a safe, off-road place. Park on a level spot, turn off the ignition and turn on the hazard warning flasher system.

Because of the size and weight of this vehicle and its tires, and the possible complications involved in tire changing, we strongly advise obtaining professional road service to change a flat tire whenever possible. However, if an emergency requires you to change the tire yourself, please exercise extreme caution and read all tire changing information, both in this manual and in the chassis manufacturer's operating guide.

### SPARE TIRE STORAGE

The spare tire is mounted on a swing-down frame assembly\* beneath the rear of the vehicle.

#### **WARNING**

When attempting to remove a spare tire carrier assembly from its installed position, do not place any part of your body underneath the carrier. The assembly weighs approximately 200 lbs. and, should it fall unexpectedly, bodily injury may result.

*\*The spare tire for Model 34D on Work-horse chassis is located in a storage compartment on the right (pass.) side of the coach.*



1. Remove bolts from both rear corners of carrier
2. Pry the Retainer Straps back to drop\* the carrier frame.
3. Remove Center bolt to extract spare tire.

\* When the retainer straps are unfastened and pulled back, the tire assembly is free to drop to the ground. Use a suitable hydraulic jack assembly or have an assistant use a block-and-lever device to help lower the tire assembly to the ground to avoid injury.



**MOTOR HOME TIRE CHANGING PROCEDURE**

 **WARNING**

We advise you to obtain qualified road service whenever possible. Do not try to change a tire yourself except under emergency conditions, and only by closely following instructions in this manual and the chassis operating guide.

If you do satisfactorily complete an emergency tire change, we recommend that you have the wheel nuts checked and properly torque tightened by qualified service personnel as soon as possible.

After a wheel has been properly torqued and inspected by qualified service personnel, it should be rechecked after traveling 100 miles, then again at each oil change.

*NOTE: The jack referred to in the following instructions is not supplied with the vehicle. You can obtain one from your dealer.*

A jack is designed for use as a tool for changing tires only, not for use as a leveling device or as a support when servicing.

 **WARNING**

Tire change procedures should be used in emergency situations only. The operator is advised to obtain qualified road service when possible.

**SAFETY PRECAUTIONS**

Before trying to change either the front or rear tires, follow these precautions:

1. Park vehicle on level surface only.
2. Turn off engine and set parking brake.

3. Turn on hazard warning flasher.
4. Block both front and back of tire on opposite side of wheel to be removed.
5. On soft ground, use a board or other material under jack as a firm base to ensure that the jack will not shift.

**FRONT WHEEL**

Before trying to remove the front wheel, observe the above safety precautions, then follow the procedure below:

1. Place jack under jacking point specified in your chassis operating guide. Position jack so it may be operated without placing your body beneath vehicle.
2. Screw jack extension pad out (up) until it touches jacking point surface.
3. Begin jacking until jack is firmly positioned and just begins to bear weight, but **do not** lift tire off the ground.
4. “Crack” wheel nuts loose with lug wrench, but do not unscrew nuts yet.
5. Resume jacking until wheel is free of ground.
6. Remove wheel nuts and wheel; put spare wheel in place.
7. Install wheel nuts and tighten as much as possible with wheel and tire off the ground.
8. Lower tire until tire just contacts the ground. Tighten nuts with lug wrench in sequence recommended by chassis manufacturer.
9. Finish lowering jack, then remove jack and blocks.

 **WARNING**

Upon satisfactory completion of emergency tire change, it is highly recommended that wheel nuts be properly torqued and inspected by qualified service personnel as soon as possible.

**Dual Rear Wheels**

Before trying to remove the rear wheel, follow safety precautions in the beginning of the motor home jacking procedures. Then follow the procedure below:



1. Place jack under jacking point specified in your chassis operating guide. Position jack so it may be operated without placing your body beneath vehicle.
2. Screw jack extension pad out (up) until it touches jacking point surface.
3. Begin jacking until jack is firmly positioned and just begins to bear weight, but **do not** lift tire off the ground.
4. “Crack” wheel nuts loose with lug wrench, but do not unscrew nuts yet.
5. Resume jacking until wheel and tire are free of ground.



## WARNING

DO NOT crawl under the vehicle when it is supported by a jack..

6. Remove wheel nuts and wheel.

*NOTE: When installing the outer dual wheel and tire assembly, rotate the outer dual wheel so valve stems are accessible but not touching one another. In some cases this means that the inner and outer valve stems should be in separate wheel cutout locations*

*When installing or tightening dual wheels, both wheels on the same side must be off the ground (not resting on the inner dual). This minimizes the possibility of loose wheels after correct mounting torque is applied.*

7. Mount spare wheel on studs and replace wheel nuts. Refer to your chassis operating guide for wheel nut torque and tightening sequence.

## WHEEL NUTS

To properly seat the wheel nuts and to eliminate the possibility of the wheel nuts becoming loosened while driving, they should be tightened at frequent intervals to the torque specified in your chassis operating guide. This is especially important after the first 100, 1,000 and 6,000

miles of operation after replacement of a wheel or wheel nuts.

## RECOVERY TOWING

When calling a professional towing service, we recommend that you advise them of your coach length and approximate front axle weight. This will allow the towing operator to determine the proper towing equipment to use. (This information is found on the vehicle certification label located to the left of the steering wheel.)

We recommend that you ask for an underlift (wheel lift or frame lift) type towing assembly for safe towing.

Winnebago Industries does not assume responsibility for damage incurred while towing this vehicle.

*NOTE: Consult the chassis operating guide for any additional towing instructions or precautions provided by the chassis manufacturer.*



## CAUTION

Do not lift on bumper. Damage will result to front end body parts.



## WARNING

Stay out from beneath the motor home while it is suspended by the towing assembly unless the vehicle is adequately supported by safety stands. Do not allow passengers to occupy a towed vehicle.

*NOTE: Know and obey all state and local towing regulations. Tow at reduced speed.*



**JUMP STARTING**



**WARNING**

Automotive batteries produce caustic acid, explosive gases, and electrical current which may cause burns. It is important that the instructions below are followed **exactly**, or personal injury (particularly to eyes) or property damage may result due to battery explosion, battery acid, or electrical (short circuit) burns.

- NEVER smoke near the battery or expose it to open flame or electrical sparks.
- Wear eye protection or shield your eyes while working near battery, in case an explosion does occur. NEVER lean over a battery.
- Do not allow battery fluid to contact eyes, skin, clothing, or painted surfaces. Immediately flush any contacted area with water. If eyes are affected, seek medical help after flushing.
- Remove all metal jewelry to lessen the risk of a short circuit occurring.

4. If the weak battery has filler caps, make sure the electrolyte is at proper level. Add distilled water if fluid is low. If electrolyte is not visible or appears to be frozen - **do not attempt jump starting!** A battery may rupture or explode if the electrolyte is frozen or not filled to the proper level.
5. Connect one end of the positive “+” (red) jumper cable to the positive “+” terminal of the weak battery. Connect the other end to the positive “+” terminal of the charged battery.
6. Connect one end of the negative “-” (black) jumper cable to the negative “-” terminal of the charged battery.
7. Finally, connect the remaining end of the negative “-” (black) cable to a solid, metal grounded location on the engine of the vehicle with the weak battery, at a point at least 18 inches from the battery. Do not connect to any moving parts. **THE MAIN SAFETY PRECAUTION IS TO MAKE THE FINAL GROUND CONNECTION ON THE ENGINE AT A SAFE DISTANCE FROM THE BATTERY. THIS HELPS TO REDUCE THE CHANCE OF EXPLOSION DUE TO SPARKS.**
8. Start the engine of the vehicle with the charged battery, and allow it to run for a few minutes at moderate r.p.m. Then start the engine of the vehicle with the discharged battery.
9. Reverse the above sequence **EXACTLY** when removing the jumper cables. Start by removing the cable from the ground location on the engine first, then continue in reverse sequence.

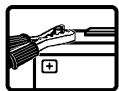

**CONNECTING JUMPER CABLES**

1. Make sure that the other vehicle has a 12-volt battery and negative ground compatible with your vehicle’s electrical system.
2. Position the vehicle with the good battery so that the jumper cables will reach, but **do not allow the vehicles to touch.**
3. Turn off all electrical accessories, motors, and lights except those needed for safety or to light up the work area. Place automatic transmission in P (Park). Be sure parking brakes are engaged in both vehicles.



**WARNING**

Do not attempt to push-start this vehicle. Damage to the transmission or other parts of the vehicle could occur.



## CONNECTING A BATTERY CHARGER

To connect a battery charger, first make sure the engine is switched off. Disconnect the negative lead from the battery. Never disconnect the battery while the engine is running or alternator damage could result.

Connect the positive “+” (red) lead of the charger to the positive “+” terminal on the battery. Next, connect the negative “-” (black) lead of the charger to a suitable ground. Finally, plug in or switch on the charger.

To disconnect the charger after charging, unplug the charger from the electrical outlets, remove the charger leads from the vehicle, and reconnect the vehicle leads to the battery.



## ENGINE OVERHEAT

If you see or hear steam escaping from the radiator or the engine compartment or have any other reason to suspect an extreme engine overheating condition, pull the vehicle over to the roadside as soon as it is safe to do so, stop the engine and get out of the vehicle.

### **WARNING**

Operating a vehicle under a severe overheating condition can result in damage to the vehicle and may result in personal injury.

An engine will overheat if the coolant is low or there is a loss of coolant because of one or more of the following:

- a leak in the cooling system
- a hose failure
- a drive belt breaking
- water pump failure

Also, be aware of the following situations, which can cause temporary engine overheating:

- climbing a long hill on a hot day
- idling while stopped in traffic for long periods of time
- towing a trailer or automobile

- stopping after a period of high speed driving

If the TEMP indicator on the instrument panel shows a rise in engine coolant temperature while driving, take the following steps to attempt to lower the overheating condition:

- If you are using the automotive air conditioner, turn it off.
- If you are stopped in traffic, shift the transmission into P (Park), and engage parking brake.

If the temperature does not drop within a minute or two:

- Pull the vehicle over to the roadside as soon as it is safe to do so.
- Place the transmission in P (Park) and press the accelerator to increase engine speed (r.p.m.’s) to twice that of normal idle speed, and hold it there for approximately two or three minutes.
- If engine temperature does not go down, turn the engine off and wait until the engine has cooled before attempting to open the hood.

When no trace of escaping steam is heard or seen, open the hood to check for the cause of the overheat. Check hose connections and tighten if necessary. Make sure there are no broken belts, pulleys or hoses before adding any coolant to the radiator.

For further information in case of overheating, consult your chassis operating guide.







(See also SAFETY PRECAUTIONS, Section 1 of this manual.)



### LOADING THE VEHICLE

**NOTE:** *Your motor home's load capacity is designated by weight, not by volume, so you cannot necessarily use all available space when loading your motor home.*

When loading the vehicle, distribute the cargo load equally so that you do not exceed either the Front or Rear Gross Axle Weight Rating (GAWR) or the Gross Vehicle Weight Rating (GVWR). The Gross Axle Weight Rating (GAWR) means the weight value specified by the chassis manufacturer as the load carrying capacity of a single axle system as measured at the tire-to-ground interfaces. This is the total weight a given axle is capable of carrying. Each axle has its own rating.

Have your vehicle weighed to determine the proper load distribution for your vehicle. Also distribute cargo side-to-side so the weight on each tire or dual set does not exceed one half of the GAWR for either axle.

For example, if the Front GAWR is 6,000 lbs., there should be no more than 3,000 lbs. on each tire. (If the left side weighs 3,100 lbs. and the right side weighs 2,700 lbs., at least 100 lbs. of the load should be shifted from the left side to the right side.) The GVWR is listed on the Vehicle Certification Label. (See Introduction Section).

The GCWR (Gross Combination Weight Rating) means the maximum allowable loaded weight of this motor home and any towed trailer or towed vehicle. If trailer towing is not recommended, the GCWR will equal the GVWR.

**NOTE:** *We recommend that you dump all holding tanks before traveling to avoid carrying unnecessary weight.*



### CAUTION

The weight of the loaded vehicle (including options, attachments, passengers, water, fuel, luggage and all other cargo) must not exceed the GVWR or GAWR of either axle.



### FRONT AXLE TIRE ALIGNMENT

**We recommend that you have the front suspension and steering alignment checked and adjusted after you have fully loaded the vehicle according to your needs. Thereafter, have alignment inspected periodically to maintain vehicle steering performance and prevent uneven tire wear.**



### WEIGHING YOUR LOADED VEHICLE

To check the weight of your fully loaded coach, locate a commercial weighing scale that is capable of weighing large trucks.

**Loading:** Load your vehicle completely as if you were going on a long trip, with everything you would carry, including food, clothing, bedding, lawn chairs, etc., a full fuel tank, full LP tank, and maybe a partial tank of fresh water - but empty holding tanks.

**Finding a Scale:** In urban areas, the most common places to find a public access scale are commercial truck stops. In rural areas, most grain storage elevators have scales available. If you don't know of a truck scale in your area, look in the Yellow Pages for entries such as Grain Elevators, Scales-Public, Truck Stops, Weigh Stations, etc. If you cannot locate a scale in your area, call your state DOT and ask for recommendations. Most scales charge a nominal fee for weighing a vehicle.



**Weighing:** There is typically a scale operator to direct you but the basic routine is to take three separate weights - front axle, whole vehicle, and rear axle. You will first drive only your front wheels onto the scale pad, then drive ahead so that the whole vehicle is on the scale, then finally pull off until just the rear wheels are on the pad.

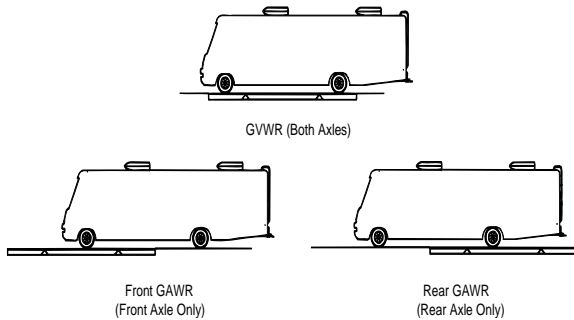

You will receive a weight 'ticket' that states your current Front Gross Axle Weight, Rear Gross Axle Weight and Gross Vehicle Weight. You can compare these weights to the weight ratings listed on your Vehicle Certification Label to use as a guideline for future loading limits and weight distribution.

The gross weight of the vehicle should not exceed the Gross Vehicle Weight Rating (GVWR) specified on the Vehicle Certification Label on the rear inner jamb of the drivers door. (see Introduction Section) The front and rear axle weight also should not exceed corresponding Axle Weight Rating specified on the Vehicle Certification Label.



**MAXIMUM OCCUPANCY**

The following label is placed in a visible location in the driver compartment.

**BELTED SEATING POSITIONS MAY EXCEED SLEEPING CAPACITY OF THIS VEHICLE. SEE OWNER MANUAL FOR OCCUPANCY AND WEIGHT RESTRICTIONS.**

The number of belted seating positions in your motor home may exceed the number people used to determine maximum coach occupancy, called the Cargo Carrying Capacity (CCC).

To calculate the CCC, Winnebago uses vehicle sleeping capacity, however your coach may be equipped with more belted seating positions than sleeping positions to give passengers a choice of seating arrangements. You may use all of the belted seating positions providing you stay within your vehicle's GVWR listed on the Vehicle Certification Label (in the Introduction Section). However you use or load your vehicle, it is your responsibility to keep the weight within its stated gross vehicle weight rating.



**ROOF LOADING**

The roof is capable of carrying some light-weight articles while the vehicle is in motion. A roof-mounted luggage carrier designed for this purpose is available from your dealer. However, roof load while the vehicle is in motion is not to exceed 10 pounds per square foot or a maximum of 100 pounds.

When the vehicle is stationary, a cargo load of 100 pounds plus the weight of a 225 pound person to load the cargo or to conduct inspection and maintenance is permissible.

Weight added to both the roof and the trailer hitch contribute to the gross vehicle weight, which must not exceed the vehicle's GVWR.



**CAR OR TRAILER TOWING**

Hitch pulling capacity: ..... 5,000 lbs. max.  
Tongue weight: ..... 350 lbs. max.

The factory installed towing hitch on this coach is capable of pulling 5,000 lbs. load (max.), however the vertical (tongue) weight may vary according to chassis and model combinations. Do not exceed either the GVWR, the rear axle GAWR, or the chassis GCWR by the combined



loaded weight of the coach and the towed vehicle. See preceding items "Loading the Vehicle" and "Weighing Your Loaded Vehicle" for explanation of weight ratings.

Because of individual vehicle use and loading habits, we recommend weighing the vehicle while fully loaded to avoid exceeding any of the listed Gross Weight Ratings. See "Vehicle Certification Label" in the Introduction Section for information on gross weight ratings.

Towing will affect vehicle handling, durability and fuel economy. Exceeding any of the listed Gross Weight Ratings will result in unacceptable overall vehicle performance. Maximum safety and satisfaction when towing depends on proper use of correct equipment. A hitch bar of appropriate steel and size should be selected to mate with the factory towing receptor.

Installation of a proper trailer brake system is recommended. Check state regulations on trailer weight and trailer brake requirements to be sure you select the right equipment before towing.

*NOTE: If you tow a car or trailer that weighs over 1,000 lbs., it must be equipped with automatically activated brakes. See the Towing Guidelines for Winnebago Industries motor homes included in your InfoCase for maximum towing capacity and GCWR for your chassis.*

Before descending a steep or long grade when towing a trailer, reduce speed and shift into a lower gear to control vehicle speed. Avoid prolonged or frequent application of brakes which could cause overheating and brake failure.



### WARNING

For safety towing and vehicle handling, maintain proper trailer weight distribution.

The total weight of the motor home and the vehicle towed must not exceed the Gross Combined Vehicle Weight rating. Contact the chassis manufacturer to obtain the Gross Combined Vehicle Weight rating for your chassis.



### CAUTION

Exceeding any of the recommended gross vehicle weight ratings may result in vehicle damage.

Do not install a frame equalizing type hitch on your vehicle.

See also - Trailer wiring connector, page 6-9.



### PRE-TRAVEL CHECK LIST

Before starting the engine to leave on a trip, be sure your motor home has been properly prepared and maintained. This will ensure an enjoyable trip and help avoid delays. Use this checklist as a guide.

- Fluid Levels - Check and fill if necessary:
  - engine oil
  - transmission
  - power steering
  - radiator
  - brake
  - battery
  - windshield washer
- Wheel Lug Nuts - Check for tightness
- Tires - Check for proper cold inflation pressures as specified on the Vehicle Certification Label.
- Drive Belts - Check for proper condition and tension (not cracked, frayed, or loose, etc.)
- 110-Volt Generator (Optional) - Check oil level in generator engine.



### WARNING

Never check oil level in generator while engine is operating.

- Fire Extinguisher - Make sure it is fully charged and secured in mounting bracket.
- Lights - Make sure all exterior lights operate.



- Sewer and Water Supply Hose - Unhook and store.
- TV Antenna - Make certain the TV antenna and/or satellite dish are lowered and seated in their support cradles.
- Loose Items Inside the Motor Home - Store or secure items.
- Pilot Lights - Make sure all pilots are off.
- Fuel Tanks - Check level.
- Water Tank - Fill with fresh water.
- Exterior Door and Step - Make sure doors are closed, locked and step retracted.
- Seats - Adjust for comfortable position and lock in place.
- Mirrors - Adjust for maximum visibility from driver's seat.

---

## EQUIPPING FOR TRAVEL

When beginning a trip, several items should be taken in addition to the basic clothes, food and recreational items. A checklist is provided for your convenience. Remember, it is important to distribute weight and store all heavy items near the floor.

---

## TRAVEL TIPS

As you travel around the country in your motor home, you will pick up useful advice from other motor home owners.

A number of suggestions can also be obtained by reading articles and regular columns in outdoor and camping magazines. Some magazines and publishing companies print an annual park and campground directory. These can be found at your local news stand or RV supply dealer. Here are a few travel tips to begin with.

1. Always check for sufficient clearance. Know the height and width of your unit.
2. Always fill the fresh water tank at an approved potable water filling facility or a known purified drinking water source. Taste the water before filling the water tank in an unfamiliar location. The water in some areas may contain an undesirable taste. Do not use a new hose to fill the water tank. It can leave a distinct rubber or vinyl taste.
3. Showers can take a lot of water. Conserve water by taking a "Sea Shower". This is done by wetting down, turning off the water, soaping thoroughly and then rinsing.
4. Dump sewage only at approved dumping stations.
5. Store liquids in plastic containers with tight fitting caps to prevent spills.
6. Keep an eye on the water and holding tank levels. It is a good idea to dump the holding tank at least every two days.
7. When traveling with children, it is helpful to plan their wardrobe for a week. Place each days clothing in a plastic bag and label the bag with the child's name and day of the week for use.
8. Use sleeping bags whenever possible. They save laundry and take up less storage space than bedding.
9. Make sure all compartment doors have been closed and the door step has been stowed in the correct position before moving the vehicle.
10. Before traveling, make sure the refrigerator door has been secured. Use care when opening the refrigerator door after the vehicle has been stopped. Any articles that have shifted may fall out when the door is opened.
11. During peak tourist season and holidays, it is best to phone ahead and make reservations at the park where you plan to stop.
12. Some states or cities will not permit vehicles with LP gas containers to pass through highway tunnels. If your route includes a tunnel, check with the highway patrol or department of highways to avoid inconvenience.
13. Do not leave food or odor-causing material in your vehicle for extensive periods of time. Always allow damp clothing, swimwear, hunting gear, etc., to dry before stowing.
14. Become familiar with the fire extinguisher and make sure it is always fully charged. Remove and replace it and read instructions so you know the correct operating procedure before an emergency happens
15. Make a list of all groceries, fresh meats, vegetables, newspapers, etc., that you may need and try to pick them up during your last fuel stop of the day. This will prevent leaving a good parking spot once you have arrived at your destination.



16. When you sit over the front wheels while driving, as in a motor home, you have a tendency to crowd the middle of the road. Check the side view mirror frequently to observe how close you are driving to the center line.

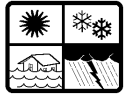

### SEVERE WEATHER INFORMATION

One of the more serious conditions affecting the motor home traveler and camper is that of the weather. Whether you travel the high mountain terrain, the lower deserts and flatland or the plains of the midwest, the weather is always with you and subject to change, sometimes with little or no warning. However, adequate warnings are normally broadcast over local radio and TV stations.

Motor home travelers and campers often seek secluded areas for weekend recreation or extended summer vacations. Many recreational areas are vulnerable to severe weather situations, especially flash flooding conditions. A few simple precautions may help lessen the hazards of flash flooding or reduce your immediate involvement.

*NOTE: We recommend that all motor home occupants become familiar with these safety precautions, and be alert to change in weather.*

- Be alert, because thunderstorms can form at any time, in any month of the year. Thunderstorms can produce large amounts of rain over a small area in a short time, which may result in a flash flood. Listen frequently to weather reports on the radio for weather and flood conditions.
- When camping near a stream, leave plenty of sloping bank between you and the stream.
- Avoid deep canyons and dry washes during stormy or threatening weather. Be aware of alternate exits.
- If heavy rain occurs, move to high ground immediately (at least 30-40 feet above the canyon floor or bottom of dry wash).

- During a flash flood, if you cannot move your vehicle, abandon it. Do not attempt to return to your vehicle before the water has receded.
- Do not attempt to wade to your vehicle if the water is above your knees - fast moving water exerts an enormous amount of pressure, making it impossible to remain standing or walking.
- Do not try to drive through flooded areas.
- Follow instructions of local authorities. Leave immediately when advised to do so. Many lives have been lost because people did not heed warnings.
- Have on hand survival supplies for several days, including food, water, first aid equipment and necessary medications. In desert areas during hot weather allow 3-4 gallons of drinking water per person, per day.
- Before you leave home, inform someone of your destination and when you expect to return. Authorities at your destination should be notified immediately if you do not arrive on time.

### REMEMBER THESE TERMS:

**WATCH:** Severe weather may develop in the specified area. Be alert and prepare for possibility of an emergency.

**WARNING:** Severe weather is occurring or is imminent in certain areas. Move to a safe location immediately.

The weather-band feature of your RV Radio™ lets you hear up-to-date weather reports from local offices of the National Weather Service (NWS). Recorded messages that last from three to five minutes are replayed continuously around the clock with updates about every three or four hours. When weather threatens, these messages are updated more frequently. If necessary, the weather service will 'break in' with storm watches and warnings and live reports when the situation demands.

See the RV Radio™ manufacturer's operating guide in your InfoCase for instructions on using the weather radio feature.

**NIGHTTIME DRIVING**

- Make sure all running lights and signal lights are clean and in working order. Have your headlights periodically checked and adjusted.
- Use care when passing other vehicles. Your motor home is a longer vehicle than a car, and you may have a more difficult time knowing when to pull back into your lane. If possible, have another person in the coach help you watch while maneuvering your motor home in traffic.

**MOUNTAIN DRIVING**

Special techniques must be used when driving in mountainous or hilly country.

**Climbing A Hill**

The transmission will automatically downshift as needed to climb most hills. If the hill is long or very steep, however, you may need to manually shift to a lower gear to keep the transmission from repeatedly upshifting and downshifting. Select the lowest adequate gear range for the duration of the incline. See your chassis operating guide for more information.

**CAUTION**

Observe the engine temperature gauge more frequently than normal. If overheating occurs, pull off to the side of the road and allow the engine to thoroughly cool before refilling the radiator and restarting the engine.

**Descending A Hill**

When going down a long grade, you may need to manually shift to a lower gear rather than keeping your foot on the brake pedal. A lower gear will allow the engine to provide a degree of brak-

ing action. Holding your foot on the brake pedal for an extended period may cause brakes to overheat, which could cause you to lose control of the vehicle. See your chassis operating guide for more information.

**CAMPSITE SELECTION**

Try to pick as level a spot as possible on which to park your motor home. Whether you nose into a parking site or back into it depends on personal preference and the location of the site's utility hook-ups. Remember that the utility connections on your motor home are on the left (driver) side of the vehicle.

**LEVELING**

Leveling the motor home is very important, not only for your comfort but for appliances and plumbing as well. Some refrigerators are extremely sensitive to being unlevel. The ammonia vapor cooling system used in most RV refrigerators can "lock-up" and damage the refrigerator if it is not level. This is both inconvenient and costly. Also, water and holding tank level indicators may give false readings because water level is greater at one side of the tank than the other.

The refrigerator is installed level at the factory. So, if the refrigerator is level, the motor home is level. A small bubble-level sight is included in the refrigerator to help you determine refrigerator leveling.

**Blocking**

A motor home can be leveled using several methods, including sophisticated electronic-hydraulic systems. The most common and inexpensive method, however, is "blocking."

This is done by stacking various lengths of planking (blocks) into a ramp-like formation in a low spot to drive the tire onto, thus leveling the coach as shown.

Wedge a pair of wheel chocks or similar devices in front and back of a tire that is on the ground to keep the coach from rolling forward or backward off the leveling blocks.

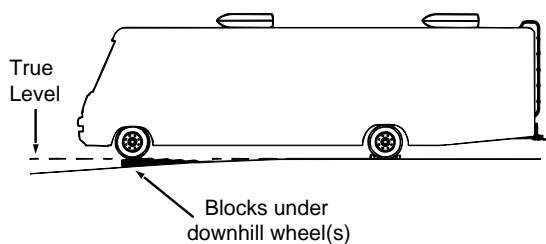

Leveling Your Motor Home

When placing blocks beneath a set of rear dual wheels, be sure the blocks support both tires so that the load weight is not resting on one tire, which could damage that tire.

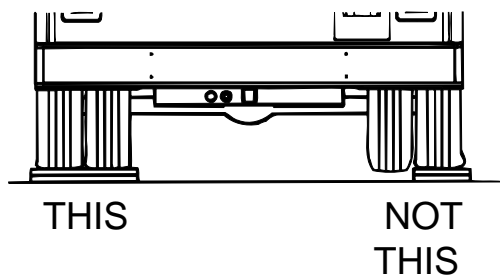

Blocking Rear Duals

To provide extra firmness, you can place inexpensive mechanical jacks, jack stands or hydraulic “bottle” jacks under the frame to keep the coach from moving on the suspension springs while walking around inside the coach. These devices are not intended to lift the coach; only to hold it rigid and steady.

*NOTE: We do not recommend lifting any of the wheels off the ground for leveling. This could allow the coach to roll off the jacks, possibly resulting in damage to the vehicle.*

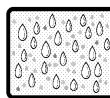

### HUMIDITY AND CONDENSATION

Moisture condensing on the inside of windows is a visible indication that there is too much humidity inside the coach. Excessive moisture can cause water stains or mildew which can damage interior items such as upholstery and cabinets.

When you recognize the signs of excessive moisture and condensation in your coach, you should take immediate action to minimize their affects.

You can help reduce excessive moisture inside the motor home by taking the following steps:

**Ventilate with outside air:** Partially open one or more windows and a roof vent to circulate outside air through the coach. In cold weather, this ventilation may increase use of the furnace, but it will greatly reduce the condensation inside the coach.

**Minimize moisture released inside the coach:** Run the range hood fan while cooking, and open a bath vent while bathing or showering to carry water vapor out of the coach. Avoid making steam from boiling water excessively or letting hot water run. Avoid bringing extra moisture into the coach by way of soaked clothing or snow on shoes. Do not hang-dry wet overcoats or clothing inside the coach.



### EFFECTS OF PROLONGED OCCUPANCY

Your motor home was designed primarily for recreational use and short term occupancy. If you expect to occupy your coach for an extended period, be prepared to deal with condensation and humid conditions that may be encountered.







(See also Safety Precautions, Section 1 of this manual.)



### LP GAS SUPPLY

The LP gas system supplies fuel for the range, water heater, furnace and refrigerator (while in gas mode). When used and handled properly, this system is safe and economical and provides modern living conveniences wherever you travel.



### SAFE USE OF THE LP GAS SYSTEM

The LP system is designed and built with strict adherence to federal, state and recreational vehicle industry requirements for mobile LP gas equipment.

For your safety, there are many safety devices and backup systems installed, such as tank fill overflow valves, an interior LP gas detector/ alarm, and an interior carbon monoxide (CO) detector/alarm.

LP gas also contains an odor additive that you can smell if LP is present in the air.

Listed below are a few precautions to observe that will help you to use the LP gas system safely.

- Exercise caution at all times. Be familiar with the distinctive odor of LP gas. If a leak is suspected, turn off the supply valve immediately. Have the LP gas system checked by your dealer or a qualified LP gas service center.
- Do not tamper with the LP gas piping system, pressure regulator or gas appliances. Service and maintenance of LP gas system components should be performed only by your dealer or a qualified LP gas service center.
- Never attempt to connect natural gas to the LP gas system.

- Have the entire LP gas system inspected for possible leaks and missing or damaged parts at each tank filling. Also inspect before and after each trip, and any time trouble is suspected.
- Turn the LP supply valve off when not using the LP gas system.
- Never use a wrench to tighten the tank supply valve. It is designed to close leak-tight by hand. If a wrench is required to completely close the valve, it is defective and must be replaced.
- Never allow the tank to be filled above the 80 percent level indicated by the flow of liquid gas out of the overflow valve or by the automatic stop-fill device.
- Be sure appliance and outside vents are open and free from obstruction when using the LP gas system.
- Never attach a lock or any device requiring a key to the LP tank compartment door. According to standards set for recreation vehicles, the LP supply valve must be readily accessible in an emergency.
- Exercise caution when drilling holes or attaching objects to the walls. Gas lines and electrical wiring could be seriously damaged and present an extreme safety hazard.

### HOW LP GAS WORKS

LP (Liquified Petroleum) gas is a true gas compressed into liquid form for easy transportation and storage. LP gas is available in two types - propane and butane. It is also called tank gas, bottle gas, or simply LP.

LP is used by appliances in vapor form only, but is stored in the tank as a liquid under very high pressure. As the liquid gas is released, it reverts back to a vapor and expands to many times its compressed volume.



## LP Gas Tank

|                                  |                            |
|----------------------------------|----------------------------|
| Brave models 30W .....           | 18 gal.*<br>(23 gal. w.c.) |
| Brave model 32V, 34D & 36M ..... | 23 gal.*<br>(28 gal. w.c.) |

\*LP Gas tank capacity shown is the usable “full” LP gas capacity, which is 80% of the tank manufacturer’s listed water capacity (w.c. shown in parenthesis). An LP tank must have at least 20% of tank volume free to allow for expansion and proper vaporization of the liquid fuel. The tank is also equipped with mandatory safety shut-off equipment that prevents filling above this level.

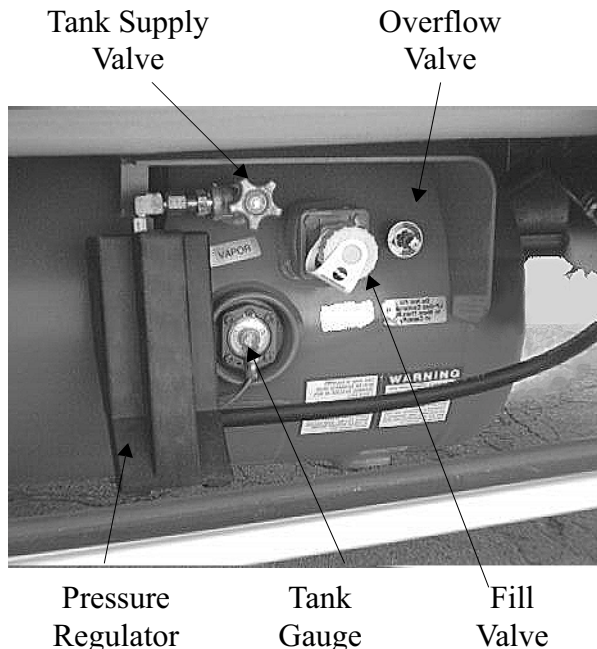

## LP GAS OUTPUT

Each gallon of liquid LP gas contains approximately 92,000 BTU’s of heat energy; or about 36.2 cubic feet of dry gas for cooking, heating, water heating and refrigeration.

To find out how long a gallon of LP gas will last, you should determine the total BTU **input** on all your LP gas appliances in use. Let’s say you have a furnace that has a 10,000 BTU **input** per hour of operation. A gallon of LP gas would last 9.2 hours of continuous operation (92,000 BTU’s ÷ by 10,000 BTU’s = 9.2). To estimate how long a gallon of LP gas lasts, try to determine what your total daily BTU input is, then divide into 92,000 to arrive at an approximate daily LP gas consumption.

## LP TANK SYSTEM

The storage reservoir for the LP gas system is a horizontally mounted tank which is permanently attached to the vehicle frame. The tank is accessible only from the outside of the vehicle. The tank supply valve is located near the top center of the tank, next to the regulator. Before opening the supply valve, check to be sure all controls for gas appliances are in the “Off” or “Pilot Off” position. If this step is not performed, LP gas could accumulate inside the motor home creating a fire or explosion hazard.

**WARNING**

**Do not** alter or remove LP tank gauge at any time.

## SELECTING LP FUEL TYPES

We recommend using straight propane in your LP tank. Propane gas is commonly available at all LP gas outlets in the U.S. (According to the National LP Gas Association, LP gas outlets in the United States do not offer any other type of liquefied petroleum gas than propane to the general public.) Check local phone directory yellow pages for locations of local LP gas refilling stations or bulk dealerships.

*NOTE: If you travel outside the U.S. with your motor home, you may find butane or propane/butane mixtures available in addition to propane. Because gas-burning RV appliances are designed to run on propane only, we recommend that you request straight propane only. Butane burns about 30 percent hotter than propane and can overheat some appliances, particularly refrigerators, and cause permanent damage. Other appliances designed to operate on propane can be-*



*come sooted and lose efficiency by using butane fuel.*

## REFILLING LP TANK

There are many LP gas refueling stations located throughout the country. These stations are listed in the telephone directory Yellow Pages under “Gas - Liquefied Petroleum - Bottled and Bulk.”

Since the LP tank is permanently mounted to the frame, the motor home must be taken to an LP dealership for filling. Do not attempt to remove the LP tank from the vehicle. The tank is equipped with a fill adapter with both internal and external threads which allows easy filling with any LP filling equipment. The tank is full when liquid LP gas appears at the overflow valve.

*NOTE: The LP tank is equipped with an automatic 80% stop-fill device.*

### **WARNING**

Make sure the filling attendant uses the 80% overflow valve when filling the tank. A tank should never be filled above 80% level to allow for vaporization and liquid expansion.

Do not place LP gas containers inside the vehicle. LP gas containers are equipped with safety devices which relieve excessive pressure by discharging gas to the atmosphere.

Do not place LP gas containers, gasoline, or other flammable liquids inside the vehicle. Fire or explosion may result.

## AIR IN THE LP GAS TANK

If your LP gas appliances do not stay lit or require frequent adjustment, even though you know the LP tank contains sufficient fuel, the problem may be air in the LP gas tank. Air in the tank mixes with the LP gas vapors causing them

to burn poorly. This condition could linger for weeks if the air is not purged from the tank. Most LP gas dealers have equipment for purging air from LP gas tanks and will purge before refilling the tank.

## TRAVEL WITH LP GAS

It is illegal for vehicles equipped with LP tanks to travel on certain roadways or through certain tunnels in the U.S. To avoid inconvenience, check state regulations concerning flammable gas transportation.

### **WARNING**

Do not alter or remove LP tank gauge at any time.

### **WARNING**

**DO NOT FILL CONTAINER TO MORE THAN 80 PERCENT OF CAPACITY.** Make sure the motor home is level when filling. It is possible to accidentally overfill the tank if the vehicle is unlevel, with the fill valve on the uphill side. Overfilling the LP gas tank can result in uncontrolled gas flow, which can cause fire or explosion. A properly filled container will contain approximately 80 percent of its volume as liquid LP gas.

**All pilot lights must be extinguished** and supply valve closed before refilling LP gas tanks or vehicle fuel tanks.

**Do not smoke or expose an open flame** while near an LP refueling area. LP gas is heavier-than-air and extremely flammable.

**Never use an open flame** to test for LP gas leaks.

Replace all protective covers and caps on LP system before filling.

**Never fill the LP tank** with engine or generator running.



**REGULATOR**

The pressure regulator is protected from the elements by a plastic cover which should be left in place at all times. Only your dealer or a qualified LP gas service should remove the regulator cover for adjustments.



**WARNING**

Inspect the pressure regulator vent hole periodically for blockage. If any obstruction is apparent, have the regulator serviced by your dealer or a qualified LP gas service center.

LP gas regulators are installed with the diaphragm vent facing downward. Make sure that the regulator vent always faces downward to minimize vent obstruction which could result in excessive pressure, causing a fire or explosion.

Regulator freeze-ups are caused by the presence of moisture in fuel. This moisture will pass through the cylinder valve and into the regulator where it can freeze. Fuel producers, tank and bottle manufacturers and LP gas dealers take every precaution to reduce moisture, but sometimes only a fraction of an ounce entering the tank can cause problems. To help avoid the possibility of freeze-up, always keep tank control valve closed when not in use, even when tank is empty, to prevent moisture from collecting on the inside.

If regulator freeze-up should occur, you may attempt to thaw the regulator using a light bulb. **DO NOT USE AN OPEN FLAME OR HEAT LAMP.**

Be sure vent hole is not blocked

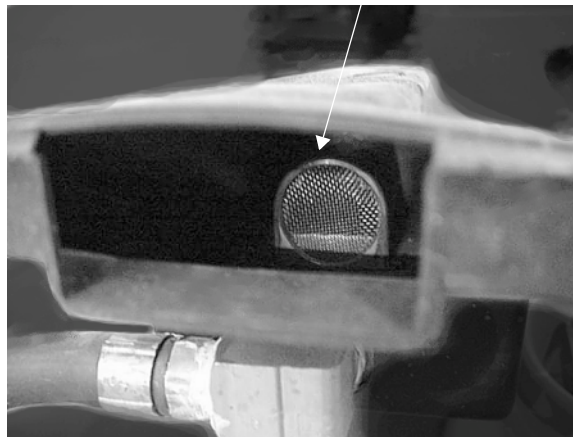

If moisture begins to cause problems, have your LP gas dealer inject a small amount of dry methyl alcohol in your tank (approximately one ounce to 20 pounds or one pint to 100 gallons) to help guard against regulator freeze-ups.

In very cold weather when a large volume of gas is being used for heating, it is possible to experience a loss of gas pressure. At first, this problem may appear to be caused by a regulator freeze-up, but is actually caused by failure of the liquid gas to vaporize as fast as it is needed. As the temperature becomes colder, it is increasingly harder for the liquid LP gas to vaporize. At the same time, the demand for LP to produce heat increases to the point where the system cannot maintain production.

The only solution to this problem is to reduce the consumption of gas where possible. Adjusting the temperature on the gas/electric refrigerator may be a first step. Using less hot water will help as well.



**LP GAS LEAKS**

The following label has been placed in the vehicle near the range area. If you smell gas within the vehicle, quickly and carefully perform the procedures listed.



**▲ DANGER**  
**IF YOU SMELL GAS**

1. EXTINGUISH ANY OPEN FLAME, PILOT LIGHTS AND ALL SMOKING MATERIALS.
2. DO NOT TOUCH ELECTRICAL SWITCHES.
3. SHUT OFF THE GAS SUPPLY AT THE TANK VALVE(S) OR GAS SUPPLY CONNECTIONS.
4. OPEN DOORS AND OTHER VENTILATING OPENINGS.
5. LEAVE THE AREA UNTIL ODOR CLEARS.
6. HAVE THE GAS SYSTEM CHECKED AND LEAKAGE SOURCE CORRECTED BEFORE USING AGAIN.

FAILURE TO COMPLY COULD RESULT IN  
EXPLOSION RESULTING IN DEATH OR  
SERIOUS INJURY.

**▲ WARNING**

Never use an open flame to test for gas leaks.

## LP GAS ALARM - See page 1-2.

**▲ WARNING**

Never use an open flame to test for gas leaks. When testing for gas lines leaks with a soapy water solution, DO NOT use a detergent containing ammonia or chlorine. These substances may generate a chemical reaction causing corrosion to gas lines, resulting in dangerous leak conditions.



## WINTER USE OF LP GAS

Due to vaporization characteristics of LP gas, it is important that the winter camper knows how to most efficiently use the LP system. The vaporization rate of LP gas decreases in a direct relationship to a decrease in temperature. Propane will convert to a usable gas at temperatures down to -44°F. For this reason, propane is a popular heating fuel in cold climates.

The greater the amount of liquid gas in the tank (up to 80% level) the greater the amount of LP gas vapor generated. The following is an example of the number of BTU's available from a 20-gallon tank at 0° F at three levels. As you can see, the number of BTU's decreases as the tank is emptied. Nearly twice as many BTU's are available from a full tank than one that is one-fourth full.

| <b>BTU's Available at 0° F.</b> |              |
|---------------------------------|--------------|
| <u>Tank Level</u>               | <u>BTU's</u> |
| 80%                             | 64,000       |
| 50%                             | 50,400       |
| 20%                             | 33,000       |

The following LP Gas Vaporization and Temperature Relationship chart typifies the LP gas loss with a decrease in temperature. The percentage figures are the increase or decrease of vapor that would be available at 0°F. These figures apply to any size LP gas tanks.

| <u>Temperature</u> | <u>Percentage of BTU's Available at 0° F.</u> |
|--------------------|---|
| 20° F.             | 200%  |
| 10° F.             | 150%  |
| 0° F.              | 100%  |
| -5° F.             | 75%   |
| -10° F.            | 50%   |
| -15° F.            | 25%   |
| -20° F.            | 12 1/2%                                       |
| -44° F.            | Propane will not vaporize                     |





(See also Safety Precautions, Section 1 of this manual.)

Your motor home is equipped with an electrical system consisting of two separate voltages; a 12-volt DC system and a 110-volt AC system. The 12-volt system consists of two internal power sources, while the 110-volt system is operated from an outside power source or the optional 110-volt generator. All systems operate through a single power converter control center to provide electrical power to the motor home.

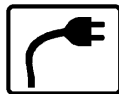

### 110-VOLT AC SYSTEM

The 110-volt system operates from an outside 110-volt utility service such as those at campgrounds, or from the optional 110-volt generator. When the power cord is connected to an outside power source, or when the generator is in operation, the power converter automatically changes a portion of the 110-volt current to 12-volt DC current. All equipment in the motor home that is normally powered by the auxiliary battery is then powered through the converter.

In addition, the following equipment is entirely dependent on 110-volt current: roof air conditioner, refrigerator (when placed in AC mode), microwave oven, and any 110-volt electrical equipment used at convenience outlets.



### EXTERNAL POWER CORD (Shoreline)

The external utility power cord (commonly referred to as a “shoreline”) is stored in the utility compartment on the left (driver’s) side of the coach.



### WARNING

**Do not** connect the external power cord to any receptacle **until** you have contacted the owner and/or attendant of the premises to verify proper polarity and grounding.

It is the responsibility of the owner of the electrical receptacle to ensure that the receptacle is properly wired and grounded.

Reverse polarity and improper grounding of the vehicle can cause personal injury or death.

To connect to an external power source, remove the cord from the storage compartment and plug it into a suitable power receptacle.

An access hatch in the compartment floor lets you route the shoreline cord out the bottom of the compartment so you can shut the compartment door while the shoreline is connected.

The shoreline cord is designed to ground the electrical system through the receptacle. It is also designed to carry the amperage output of most campground outlets. If the electrical receptacle to be used is designed to mate with the prongs on the power cord plug, the electrical connection can be expected to carry rated load.

Your coach may be equipped with either 30-amp or 50-amp shoreline service depending on the power requirements of electrical appliances and equipment in the coach. You can tell which type you have by looking at the prongs on the shoreline plug.

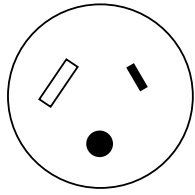

30 Amp Receptacle

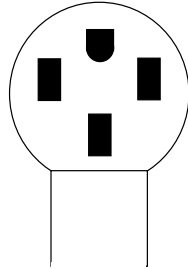

50 Amp.  
Power Receptacle

The optional 50-amp shoreline gives your coach extra current handling capacity. This allows you to run the central air conditioning system at maximum (both compressors running) while using other electrical equipment without fear of constantly tripping the shoreline pole circuit breaker.

*NOTE: Some parks do not have 50-amp service available, so you will need to connect to a standard 30-amp service pole using an adapter.*

## POWERLINE ENERGY MANAGEMENT SYSTEM (EMS)

The PowerLine energy management system (EMS) monitors the electrical usage of the appliances and equipment in the coach and distributes the electrical loads to avoid nuisance tripping of the shoreline circuit breaker. This systems works together with the energy efficient Coleman Power Miser roof air conditioner units to allow you to run both front and rear units at the same time on a 30-amp shoreline connection.



Please read your PowerLine Energy Management System Owner's Guide for important information on running both front and rear roof air conditioner units at the same time. This guide will also explain how this system operates under several conditions, whether 20-amp or 30-amp connections.



### **WARNING**

**Do not** plug the power cord into an outlet which is not grounded, or adapt the plug to connect to a receptacle for which it is not designed.

Be sure that all three prongs of the supply cord are properly plugged into the receptacle.

**Do not** connect the power cord to an extension cord.

## Park Fuses or Breakers

Most campgrounds are equipped with a fuse or circuit breaker at the shoreline pole. This protects the park's wiring, as well as the power cord on your vehicle, from electrical damage. If electrical power fails, contact the park attendants and have them check the fuse or breaker for your supply receptacle.

After disconnecting the power cord, neatly replace it on the hanger bracket in the storage compartment.

## POWER CENTER (Converter)

The power center changes 110-volt AC current from the auxiliary generator or the shoreline into 12-volt DC current for use by 12-volt equipment in the motor home.

Certain circuits, however, remain unchanged for use by items which require 110-volt current, such as the air conditioner(s), the refrigerator in AC mode, the microwave oven, etc.

Current drawn from the coach batteries passes through the power center unchanged, although it is routed through a series of protective circuit breakers.

The converter is located in a lower cabinet in the galley, living area.





## **! WARNING**

Do not store anything around or on top of the converter, or in front of the cover. The converter generates heat while operating, and needs unrestricted air flow for proper cooling.

### **Charging Section**

The converter charges coach batteries while 110-volt external power is connected. The converter will automatically “sense” the condition of the RV battery. If it is below “full charge”, the Charging Section will start charging the battery.

If the coach batteries have been extremely discharged, they will accept charge at a relatively high amperage rate. If they are only slightly discharged, they will charge at a lower amperage rate. The rate of charge will decrease as the batteries reach “full charge”, they will remain “trickle” charging at a very low amperage rate. If your storage battery does not charge as described above, it is possible the battery is defective.

### **Thermal Overload Protector**

A protective thermal breaker will “break” the 110-volt AC power to the converter section of the Power Center if the power converter becomes overheated. This can result from operating above its maximum limit for an extended period of time or by obstruction of ventilation to unit.

*NOTE: Power converter section will automatically route 12-volt lights and motors to battery power in this event.*

The thermal breaker will reset itself after a period of time, and the lights and motors will again resume operation from power converter section. If the breaker trips again shortly after reset, take immediate steps to correct cause of overheating. A portion of RV 12-volt load (lights or motors or both) should be turned off to reduce total load. Also, inspect power converter section to make sure ventilation is not obstructed.

*NOTE: The converter will not change 12-volt DC current to 110-volt AC.*

### **110-Volt Circuit Breakers**

The breaker panel protects all 110-volt components in the motor home from either an overload on the circuit or a short in the wiring or component itself. When an overload or short develops, the breaker will open preventing any further flow of electricity and, therefore, damage to the system.

Shut off the equipment (example: roof air conditioner) and allow a brief cooling period. Then reset the breaker by moving the switch to “Off” and back to “On”. If the breaker is continually tripped and no overload is evident, have the system checked for a short in the wiring or the appliances.



110-Volt Circuit Breaker Panel

### **Further Information**

Refer to the converter manufacturer’s information provided in your Owner InfoCase for additional information about your power converter system.

### **110-VOLT RECEPTACLES (Outlets)**

A number of standard AC electrical outlets are provided throughout the coach for connecting small appliances such as televisions, radios, toasters, etc. Outlets are also located on the outside of the coach near the entrance door.



**GROUND FAULT CIRCUIT INTERRUPTER**

Exterior, bath and galley outlets are connected to a GFCI (Ground Fault Circuit Interrupter), which is an extremely sensitive circuit breaker that will help to protect against severe electrical shock if a ground fault develops. If such a condition occurs, the GFCI will break the circuit by turning off the power to the protected outlets. Should this occur, unplug all the appliances on that circuit and press the reset button on the GFCI equipped outlet.

If the GFCI keeps tripping, have the electrical system checked and repaired if necessary before using again.

The GFCI outlet is located in the bath, bedroom or dinette area, depending on the floor plan of the vehicle.



**RESET**  
(Red)  
Press to reconnect circuit after monthly testing or ground fault tripping.

**TEST**  
(Black)  
Press at least monthly. Should break circuit. Press **RESET** button to reconnect.

GFCI Outlet  
(Ground Fault Protector)



**WARNING**

The GFCI will not completely eliminate electrical shock. Small children and persons with heart conditions or other disabilities which make them especially sensitive to electrical shock may still be injured by a 110-volt receptacles even though protected by a Ground Fault interrupter.

*NOTE: In compliance with CSA electrical codes, the galley appliance outlet in Canadian equipped coaches is not connected to a GFCI protected circuit.*

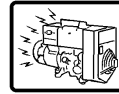

**AUXILIARY 110-VOLT GENERATOR**

Consult the information provided in your Owner InfoCase for instructions on operation, troubleshooting and maintenance.



**WARNING**

**Careless handling** of the generator and electrical components can be fatal.

**Never** touch electrical leads or appliances when your hand are wet, or when standing in water or on wet ground.

**Do not** attempt to repair the generator yourself. Service should be performed by an authorized service center.

**Do not** plug the power cord into the generator receptacle while the generator is running.

Whenever the generator is needed, an automatic power transfer system automatically switches the household electrical system to the generator 10 seconds after the generator is started. The ten-second delay allows the generator to start easily without the burden of electrical loads.

**Starting and Stopping the Generator**

The generator switches are located on the dash and on the monitor panel. The generator starter circuit does not rely on the automotive battery, so the switch will operate whether the ignition switch is on or off.

This coach may be equipped with one of several models of generators. Consult the generator owner's manual in your Owner's InfoCase for specific instructions on starting and stopping your generator.

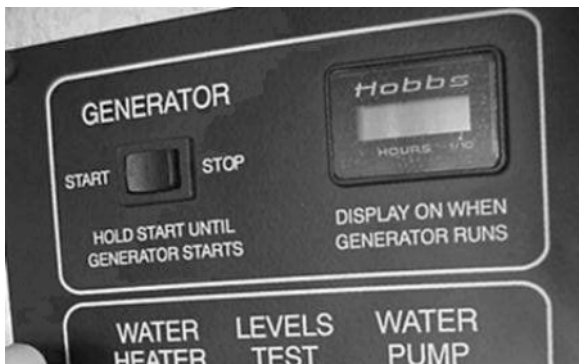

## Basic Generator Operation:

### Starting:

- See generator manufacturer's operating information for specific instructions.
- Reduce all electrical loads. (Shut off lights, fans, appliances, etc.)
- If the generator has not been run for two weeks or more, you may need to prime the fuel system before attempting to start.
- Press the generator starter switch on and hold until generator engine is running, then release.
- Let the generator engine stabilize and run smoothly before turning appliances or electrical equipment on.
- Refer to the output specifications of your generator in the generator manufacturer's manual.
- Do not overload generator by turning too many items on. Overloading will cause the circuit breaker on the generator to trip. If this happens, the generator will run but no electricity will be present in the coach. You must then reset the circuit breaker on the side of the generator. See load chart for estimation of typical RV loads.

### Stopping:

- Before shutting generator down, turn off electrical loads and let engine run at no-load for a few minutes to cool down.
- Press the generator switch Off and hold until the generator engine comes to a complete stop.

| Approximate Power Requirements of Common Appliances |  |
|---|--|
| Appliance or Tool                                   | Approximate Power Consumption (Watts/Amps) |
| Vacuum cleaner                                      | 200-500W/1.7-4.3A                          |
| Coffee Maker  | 550-700W/4.8-6.1A                          |
| Hair dryer  | 800-1500W/7.0-13.0A                        |
| Electric clothes iron                               | 500-1200W/4.3-10.4A                        |
| Electric blanket                                    | 50-200W/0.4-1.7A                           |
| Television  | 80-100W/0.7A                               |
| Electric drill                                      | 250-750W/2.2-6.5A                          |
| Air conditioner                                     | 1400-2000W/13-19A                          |
| Converter   | 300-500W/2.6-4.3A                          |
| Microwave Oven                                      | 700-1500W/6.0-13.0A                        |

### Generator Hourmeter

This meter is located on the One Place panel. It registers the total number of hours that the generator has been operated. Refer to the hourmeter to determine when periodic maintenance is due and to record services which have been performed.



## Operation Warnings and Cautions



### **WARNING**

The exhaust of all internal combustion engines contains carbon monoxide (CO). This poisonous gas is colorless, odorless, tasteless, and lighter than air. The exhaust systems of both your motor home engine and your generator engine have been installed with your safety in mind. However, certain precautions must be taken when using them to protect yourself from conditions beyond the control of the manufacturer.

1. **Do not** simultaneously operate the generator engine and a ventilator which could draw exhaust gases into the vehicle.
2. **Do not** open windows or ventilators on the end or side of the vehicle where exhaust pipe of the generator is located.
3. **Park the vehicle** so that the wind will carry the exhaust away from the vehicle. Also, note the position of other vehicles to be sure their exhaust will not enter your vehicle.
4. **Do not** operate the generator engine when parked if vegetation, snow, buildings, vehicles, or any other object can deflect the exhaust under or into the vehicle.

Check auxiliary generator oil level frequently during periods of use. Refer to the generator manufacturer's information in your Owner Info-Case for specific recommendations.



### **WARNING**

Never check generator oil level while generator engine is running.

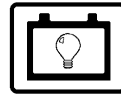

## 12-VOLT DC SYSTEM

The DC voltage system consists of the chassis battery and the 12-volt motor home auxiliary chassis batteries.

### **Chassis (Starting) Battery**

The chassis battery is used solely to operate the engine starter and all automotive accessories and controls found on the instrument panel. This includes the horn, speed control, all exterior lights, radio, windshield wipers, rear auto heater fan, etc.

### **House Batteries**

The house batteries supply current to all 12-volt equipment located in the living area of the motor home. This includes interior lights, range exhaust fan, furnace fan, water pump, water level and holding tank gauges, 110-volt generator starting, refrigerator, bath roof vent fan, and the rear automotive heater. The house batteries may also be used to start the engine if the chassis battery is dead. Refer to "Aux. Start Switch."

The house batteries are "deep-cycle" type batteries specially designed for recreational vehicle use. They will provide longer lasting power than standard automotive batteries, and will withstand the frequent drain-and-recharge cycles that occur under the demanding conditions of a camping outing.

The house batteries are automatically charged by the engine alternator while the engine is running.

### **12-Volt House Fuses And Circuit Breakers**

All 12-volt circuits and equipment in the coach area of the motor home are protected by either a fuse panel or breaker panel. When a circuit is overloaded or a short develops in any part of the system, a fuse or breaker will shut down that circuit. If this happens, turn off all affected lights or appliances and reset the breaker or replace the fuse with a new one of equal amperage rating.



House 12V Circuit Breakers

A label on the panel states the amperage rating and circuit protected for each fuse or breaker.

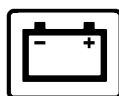

## BATTERY INFORMATION

### BATTERY ACCESS

The batteries are located beneath the top inside entrance step. Unhook the latch assembly fastening the top step and remove.

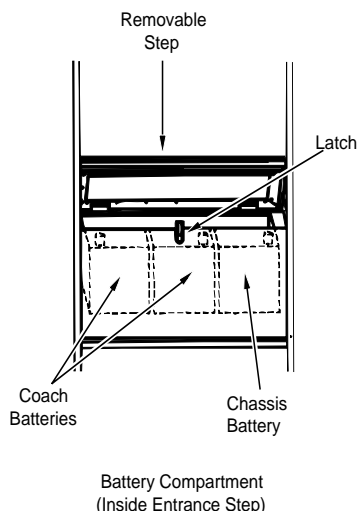

## BATTERY STORAGE AND MAINTENANCE

Lead -acid type batteries are electro-chemical devices for storing and releasing electrical charge. As such, they are simply an electrical reservoir, not an electrical source. As soon as energy is removed from the battery, it should be replaced by the engine alternator or the RV converter system.

If a battery sits unused for 30 days or more, especially during warm weather, it can develop a deposit of sulfate crystals on the metal plates inside the battery. This condition is called sulfation or sulfating, and prevents the battery from either releasing or accepting a charge. If this condition occurs, the battery must be replaced.

**If a battery does not contain at least 80% charge during freezing temperatures, the electrolyte can freeze and crack the battery case.**

**The two best defenses** against sulfating and insufficient charge are to:

1. turn off the Auxiliary Battery switch to avoid parasitic discharge (the trickle discharge caused by directly connected components like LP gas detectors or digital clock displays, etc.), and
2. check the battery and recharge as necessary at least once a month during long storage periods. Turn the Aux. Batt. Switch off to avoid electrical arcing when attaching or detaching charger clamps.



## WARNING

**California Proposition 65 Warning:** Battery posts, terminals and related accessories contain lead and lead compounds, chemicals known to the state of California to cause cancer and reproductive harm. Wash hands after handling.

*NOTE: We do not recommend leaving the shore-line plugged in continuously during storage periods because the batteries*



*can lose electrolytic fluids and become damaged from continuous charging without periodic use.*

*We recommend following regular battery inspection and maintenance, especially in cold weather.*

**Further precautions are:**

- Remove the battery from the coach.
- Store it in a cool place on a wooden or rubber pad to inhibit conductive transfer.
- Check the state of charge periodically to avoid discharge or sulfating.

To ensure that the battery will always accept and hold a charge, follow these simple maintenance practices.

- Make sure the batteries always remain securely clamped in the battery tray.
- Make sure battery cable clamps are tight on the terminal posts and are free of corrosion.
- Neutralize corrosion buildup or acid film on top of battery by washing with a baking soda/water solution. Rinse with clear water.

*NOTE: Make sure vent caps are on securely to prevent baking soda solution from entering the battery and contaminating the electrolyte fluid.*



**WARNING**

Before removing any battery cables or battery, make sure all 12-volt equipment in the motor home is off and the power cord has been disconnected.

Be sure to cap the battery terminal boot back onto the positive terminal before sliding the tray in after servicing. Care must be taken when sliding the battery tray back in, to avoid pinching the cable between the tray and the vehicle frame. Should the cable be damaged, a short could result in personal injury or damage to equipment. Replace any damaged cables at once. Always remove jewelry and wear protective clothing and eye covering when checking or handling batteries.

Reinstall the retainer pin when returning the tray to the storage position.

- Clean and tighten battery terminals and have the specific gravity checked at least once a year.
- Every two months, or more often in hot weather, check the battery fluid level. Fill to approximately 3/8 inch above the plates. **DO NOT OVERFILL.** If fluid is added during freezing weather, the motor home should be driven several miles to mix water and electrolyte to prevent freezing.
- Fluid level check may be omitted if equipped with maintenance-free batteries.

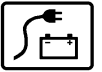

## **! WARNING**

To prevent wiring damage, it is essential when replacing the cables on the battery, or when using a “booster” battery, that the positive post and the positive cable be attached and the negative post and negative cable be attached. The posts are marked (+) plus and (-) minus. If a “fast charger” is used while battery is in the motor home, disconnect both battery cables before connecting the charger. Never attempt to charge or boost a frozen battery.



CB Wires  
(in plastic sheath)

Be sure to read the wire labels before installing a CB radio. The labels contain important information and cautions.

## BATTERY CONDITION METER

See related item under “Monitor Panel” in section 8, Appliances.

## AUX. START SWITCH

See section 2, Driving Your Motor Home for information on Aux. Start Switch.

## AUXILIARY BATTERY (Aux. Batt) SWITCH

See section 2, Driving Your Motor Home, for information on the Auxiliary Battery Switch.



## CB RADIO WIRING (Optional)

If your coach is pre-wired for CB radio installation, the wires are wrapped in clear plastic suspended beneath the left side of the dash as shown.

## SWR Adjustment

To adjust CB antenna SWR (standing wave ratio), turn the adjusting ring of the antenna to achieve lowest SWR reading. This procedure will help optimize transmitting and receiving capabilities of the CB radio system.

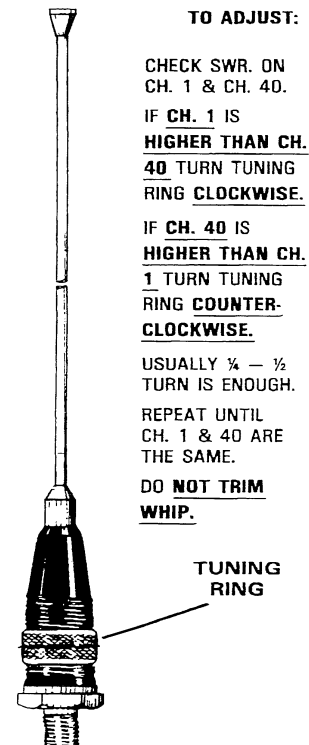



**CAUTION**

The CB radio could become damaged if the CB antenna SWR is not adjusted before operating the CB radio.

---

**TRAILER WIRING CONNECTOR**

Your coach is pre-wired for trailer or car towing lights with a 6-pin socket on the rear bumper. The connector plug is supplied in the coach parts package provided to you by your dealer when you took delivery of the vehicle.

The diagram shows proper connection of trailer or tow vehicle wiring to the coach light system. Remove the small screw near the end of the plug and slide the contact assembly out of the barrel.

- TM = Tail Lights
- GD = Ground
- LT = Left Turn/Brake
- RT = Right Turn/Brake
- A = Backup lights

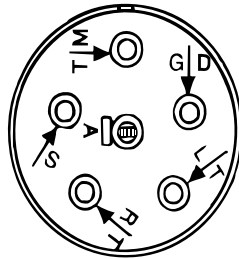



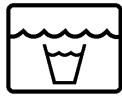

### FRESH WATER SYSTEM

The fresh water system provides water to the galley sink, shower, bathroom lavatory, toilet and water heater. Water may be supplied by either of two sources:

- a water tank located within the motor home, or
- any external water source to which the motor home may be connected, known as “city water”.

### FRESH WATER TANK FILLING PROCEDURES:

Always fill the fresh water tank at an approved potable water filling facility or a known purified drinking water source.

The tank may be filled either by gravity fill or by pressure filling through the city water connection\*. A special diverter valve will route the water from the hose either directly to the water lines for city water hookup use, or to the fresh water tank for filling.

**Gravity Fill:** Insert hose into fill opening and turn water supply on. Tank is full when water flows from tank vent tube beneath coach. The gravity fill tube is located behind a small, lockable door on the right (passenger) sidewall toward the back of the coach.

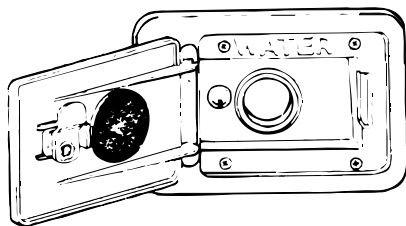

Water Tank Gravity Fill

*\*Except model 32V on Workhorse chassis, which is equipped with gravity fill only.*

**City Water Pressure Fill:** Attach hose to city water connector. Turn valve inside water center to ‘Water Tank Fill’ as shown, then turn water supply on. Tank is full when water flows from tank vent tube beneath coach.



*NOTE: Because city water pressure varies from location to location, we recommend using an **in-line water pressure regulator** to prevent damage to any components, connections and seals in your fresh water system.*

*A water pressure regulator may be obtained from any well stocked RV dealership retail center and some retail discount centers. These devices simply connect in-line between the supply hose and the city water input on the coach.*

*We recommend a regulator that controls water pressure to **40 psi maximum**.*

*NOTE: Always keep the tank fill valve closed unless you are filling the tank. If this valve is open while using the city water, the water will keep flowing into the tank and out the tank vent tube.*



**Fresh Water Tank Capacity**

|                                   |         |
|-----------------------------------|---------|
| Brave model 30W .....             | 78 gal. |
| Brave model 32V (Ford).....       | 80 gal. |
| Brave model 32V (Workhorse) ..... | 58 gal. |
| Brave model 34D.....              | 80 gal. |
| Brave model 36M .....             | 70 gal. |



**WATER PUMP**



Water Pump  
in right front compartment

When your coach is not connected to a city water supply, water is supplied from the fresh water tank by a water system demand pump.

A demand pump is designed to run when there is no water line pressure backup against the pump. This is what happens when you turn a faucet on - the water line pressure drops and the pump begins to run, and it will continue to run as long as the faucet is open. When you turn the faucet off, the line pressure backs up to the pump, and it shuts itself off.

The pump is self-priming and will run briefly to build up line pressure when the Water Pump Switch is first turned on. See “Initial Water Line Priming” for instructions on using the water system for the first time.

**Pump Strainer Filter**

The pump is equipped with a cleanable strainer filter to capture any possible tank borne particles that could damage pump components.

*Note: We recommend that you check and clean this filter after each tankful of water during the first few uses of the water pump system. Thereafter, remember to check it at least yearly, such as during winterization procedures.*

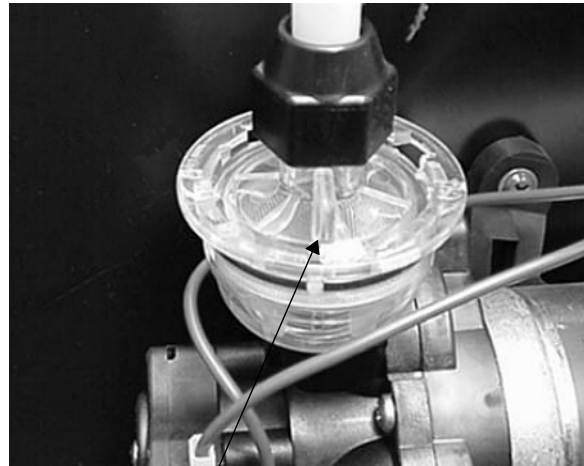

Push cover in firmly and  
twist to remove and clean strainer

*To Clean Pump Strainer*

- Press the inlet cap in towards the pump and twist counterclockwise about 1/4 turn to disengage from locking tabs.
- Remove the cap, then pull the strainer screen out of the bowl to tap out any particles and rinse clean.
- Insert the strainer screen back into the bowl, then twist the cap back onto the bowl assembly to close.

**Water Pump Switch**

The water pump switch is located on the systems monitor panel (See Section 8). While the switch is in the “ON” position, the pump will automatically supply water pressure as it is needed. It is recommended that the pump switch be turned off whenever you are away from the vehicle or not using the water system. A slow leak in a faucet could drain the water system and discharge the coach battery.



## Initial Water Line Priming

1. Make sure that all water drain valves are closed, including water heater valve. (Refer to Section 10.)
2. Turn water pump switch to “OFF” position.
3. Fill water tank.
4. Open all faucets, hot and cold.
5. Turn on pump switch.
6. Close each faucet as it begins to deliver a steady stream of water (close cold water first). Leave hot water faucets on until they also deliver a steady stream of water. This will ensure that the water heater is filled with water.
7. Check to be sure pump stops soon after all faucets have been closed.
8. Pump is now ready for automatic operation. Pump will start when a faucet is opened and stop when the faucet is closed.

## DISINFECTING FRESH WATER SYSTEMS ON RECREATION VEHICLES

(As approved by the U.S. Public Health Service)

To assure complete disinfection of your fresh water system, it is recommended that the following procedure be followed on a new system, one that has not been used for a period of time, or one that may have become contaminated. This procedure is also recommended before long periods of storage such as over winter.

1. Prepare a chlorine solution using 1 gallon of water and 1/4 cup of household bleach (sodium hypochlorite solution). With tank empty, pour chlorine solution into the tank. Use 1 gallon solution for each 15 gallons of tank capacity. This procedure will result in a residual chlorine concentration of 50 ppm in the water system. If a 100 ppm concentration is required as discussed in item 3, use 1/2 cup of household bleach with 1 gallon of water to prepare the chlorine solution. One gallon of the solution should be used for each 15 gallons of tank capacity.
2. Complete filling of tank with fresh water.

Open each faucet and run the water until a distinct odor of chlorine can be detected in the water discharged. Do not forget the hot water taps.

3. Allow the system to stand at least 4 hours when disinfecting with 50 ppm residual chlorine. If a shorter time period is desired, then a 100 ppm chlorine concentration should be permitted to stand in the system for at least 1 hour.
4. Drain and flush with fresh water.

## WARNING

Chlorine is poisonous - recap bottle and clean utensils after use.

Never use automotive type antifreeze in your potable water system as it is poisonous.

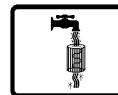

## WATER PURIFIER (FILTER) SYSTEM

The water purifier system uses a flow-through activated carbon filter that removes chlorine and other impurities, resulting in clean, taste-free and odorless drinking water.



Water Filter Assembly -  
Below Galley Sink



**Replacing the water filter cartridge:**

Replace the filter cartridge when water flow from the purifier faucet is too slow for convenience.

- Place a container beneath the filter to catch any remaining water during removal.
- Raise the valve handle near the top of the filter base to block water flow to filter.
- Twist the filter cartridge counterclockwise about a quarter-turn and pull it down and out of the filter head.



- Insert a new water filter cartridge up into the filter head as far as possible and turn it clockwise a quarter turn.
- Lower valve handle to lock filter and restore water flow.

See “Winterizing the Water Purifier System” in Section 10.

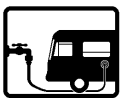

**EXTERNAL WATER SUPPLY (“City Water”)**

**To connect to an external source:**

1. Turn the demand pump switch off.
2. Attach a hose from the external water source to the city water connection in the water compartment on the left side of your vehicle.
3. Turn water fill valve to City Fill as shown.



4. Turn on the external water source (faucet).

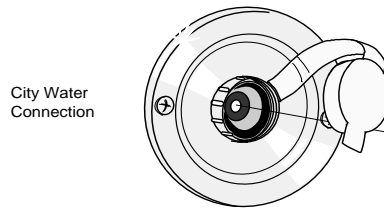

When connected to an outside source of water, the water bypasses the demand pump and storage tank and supplies pressure directly to individual faucets and toilet. A check valve built into the pump prevents water from entering the pump and filling the storage tank.

*NOTE: Because city water pressure varies from location to location, we recommend using an **in-line water pressure regulator** to prevent damage to any components, connections and seals in your fresh water system.*

*A water pressure regulator may be obtained from any well stocked RV dealership retail center and some retail discount centers. These devices simply connect in-line between the supply hose and the city water input on the coach. We recommend a regulator that controls water pressure to **40 psi maximum**.*

**To disconnect from the external source:**

1. Turn the external source off.
2. Open a faucet inside the vehicle to relieve line pressure.



3. Disconnect the hose from the vehicle and replace the cap on the connection.

## SHOWER HOSE VACUUM BREAKER

After using the shower, you may notice water dripping from the shower faucet assembly. The dripping results when vacuum in the shower hose (after closing the shower faucet) slowly releases and allows water remaining in the hose to drain down. This is a normal function of the shower valve assembly and is not a leak or defect.

The International Association of Plumbing and Mechanical Officials Standard TSC 21-85 (PAR. 4.3) states:

“Shower heads which incorporate shutoff valves, shall have a minimum “drip rate” of one (1) quart in thirty (30) minutes.”

### CAUTION

If items are placed into the shower tub before shower valve vacuum release is complete, they may become wet.

The label shown below is attached on or near the faucet to explain the operation of the vacuum breaker assembly.

For your protection, this faucet is equipped with a vacuum breaker (back flow preventer) to prevent contamination of your potable water supply. The water in the hand held shower hose will drain through this vacuum breaker when the faucet is turned off. This is not a leak. This drainage is inherent in the design of the vacuum breaker, and is evidence that it is functioning properly.

P.P.I. 0387

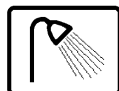

## EXTERIOR SHOWER/ WASH STATION

The exterior wash station feature allows you to do things such as rinse off sand or salt after a swim, rinsing off muddy boots, or bathing your pet outside the coach. A water pump switch is located near the shower faucet for your convenience. It is located in the water system compartment (service center) on the left side of the coach.



Exterior Shower/Wash Station



## WASTE WATER SYSTEM (HOLDING TANKS)

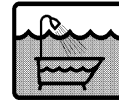

The drainage system is self-contained and uses two separate holding tanks to contain the waste water until it can be dumped at an appropriate waste water disposal site. This means you can use the toilet, sinks and shower even in areas where utility hookups are not available.

The black water holding tank contains the sewage from the toilet. The gray water holding tank contains the waste water from the galley sink, bathroom lavatory and shower.

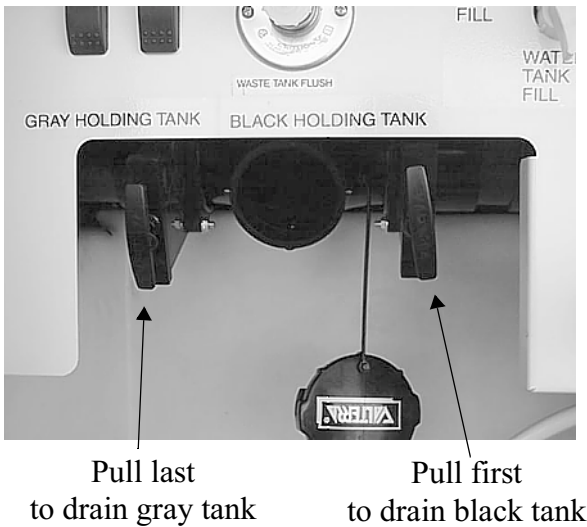

## DUMPING HOLDING TANKS

1. Remove drain hose from exterior storage compartment.
2. Remove dust cap from drain and connect drain hose. Be sure it is firmly attached.
3. Place the other end of sewer hose into disposal opening.
4. Open the black water valve with a quick pull and make sure there are no sags in the hose. Move the hose gently about to dislodge any waste and ensure complete drainage. Close black water valve as soon as tank is empty.

*NOTE: Do not open the gray water valve until the black water tank is drained and dump valve closed to avoid sewage back-up into gray tank. Gray water also rinses any black water solids from the drain hose.*

5. Open the gray water valve. Be sure there are no sags in the hose to ensure complete drainage. Close gray water valve as soon as tank is empty.
6. After both tanks have been drained, run several gallons of water into the sewage tank through the toilet. Then open sewage dump valve and drain the tank again. Close valve and replace dust cap securely.
7. It is advisable to add an odor control chemical to the sewage holding tank. These chemicals are available at most R.V. stores.

8. Rinse sewer hose thoroughly with water and stow.

*NOTE: We recommend that you dump all holding tanks before traveling to avoid carrying unnecessary weight.*

## USING ON-SITE SEWER HOOK-UPS

The drain hose may remain attached to the dump outlet and be routed out the bottom of the compartment while the motor home is parked and connected to an on-site sewage hook-up.

When using a sewer hook-up, keep the dump valves closed until a tank becomes full or when preparing to leave the site. This keeps the solids in suspension, allowing them to be carried out with the liquids when the dump valve is opened. If the valve is left open, the liquids will drain off, leaving solids in the tank. Should this accidentally happen, disconnect the hose, fill the tank about half full with water, and drive a few miles to dislodge the solids. A few starts and stops will aid in the process. Then reconnect the hose and drain in the normal manner.

## HOLDING TANK LEVEL INDICATORS

The holding tanks may be monitored on the wall mounted monitor center.

Press the "Levels Test" switch to check the level in each tank.

See pages 8-5 and 8-6 for further information on the monitor panel.

## WATER LINE & TANK DRAIN VALVES

The water drain valves are used to drain water from the water tank and the water supply lines when preparing the motor home for storage or when sanitizing the water system.

To open or close the drain valves, turn the handles in the directions indicated by the following illustration.

Drain valve locations are listed on the following pages.

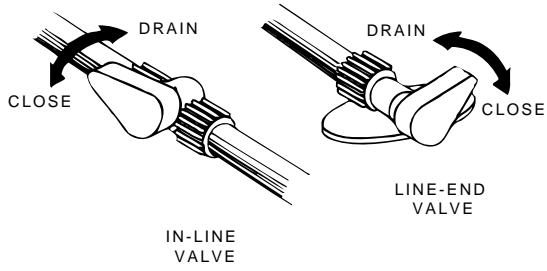

Water Drain Valves  
(typical)

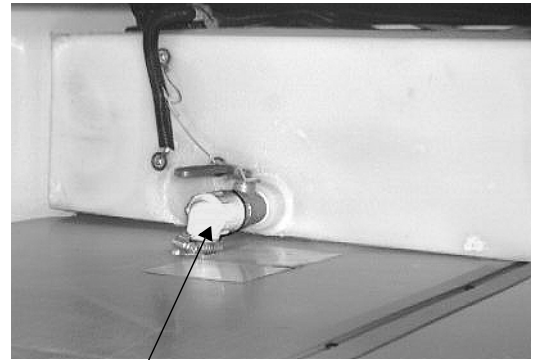

Water Tank Drain Valve  
In Right Side Rear Cargo Compartment



Water Line Drain  
in right front compartment



**TANK CAPACITIES**



**HT1 - Black Water Holding Tank**

|   |         |
|---|---------|
| Brave model 30W (Toilet & Lavatory) ..... | 40 gal. |
| Brave model 32V (Toilet) .....            | 40 gal. |
| Brave model 34D (Toilet) .....            | 50 gal. |
| Brave model 36M (Toilet).....             | 40 gal. |



**HT2 - Gray Water Holding Tank**

|   |         |
|---|---------|
| Brave model 30W (Galley & Shower).....            | 54 gal. |
| Brave models 32V (Galley, Shower & Lavatory)..... | 45 gal. |
| Brave model 34D (Galley, Shower & Lavatory).....  | 45 gal. |
| Brave model 36M (Galley, Shower & Lavatory).....  | 67 gal. |





| <b>WATER SYSTEM DRAIN VALVE LOCATIONS</b> |   |
|---|---|
| <b>SYSTEM</b>                             | <b>DRAIN VALVE LOCATIONS</b>  |
| Water Lines:                              | <p>One (1) valve in the front storage compartment on the passenger side of the coach.</p> <p>Open exterior shower faucet and lay shower head on ground.</p> <p>Also, to drain any water left in the city water line, place the tip of your finger inside the city water connection and gently press the backflow valve (small “button” in center of connector).</p> |
| Water Tank:                               | One (1) valve near the water tank in a storage compartment on the passenger side of the coach.  |
| Water Heater:                             | Drain plug on outside of coach, behind service panel. Use socket to remove drain plug.  |
| Water Heater By-Pass Valve                | By-pass valve is located in a storage compartment with the water pump.  |
| Winterization (Antifreeze) Valve          | Valve with clear vinyl siphon tube is located in a storage compartment with the water pump.   |



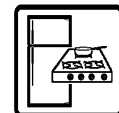

(See also Safety Precautions, Section 1 of this manual.)

*NOTE: Because this model is available in several sizes and floor plans, some items described may be optional or unavailable on your coach.*

The appliances installed in your motor home are manufactured by reputable RV appliance makers and have been tested by independent laboratories to meet all applicable standards and codes set for RV appliances. These appliances are covered by your New Vehicle Limited Warranty. (Certain items may be covered by individual manufacturer's warranty.) See your New Vehicle Limited Warranty for details.

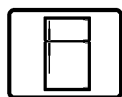

### REFRIGERATOR

The refrigerator in your coach can be operated from either of two power sources available to the motor home:

- 110-Volt AC electric
- LP gas

The refrigerator is an absorption type which uses an ammonia-water solution for cooling. Basically, ammonia vapor is distilled from the solution by heat, produced from either LP gas or electricity and then carried to the finned condenser where it liquefies. The liquid then flows to an evaporator where it creates cold temperatures through evaporation.

#### Leveling

Always park the vehicle on a level location when operating the refrigerator while parked. Operating the refrigerator off-level for longer than 1 hour can result in a form of 'vapor lock' that could permanently damage the refrigerator. Normal vehicle leveling to provide comfort for the occupants is generally satisfactory for refrigerator operation.

A small round bubble level is provided with your refrigerator. Place the bubble level on the bottom surface of the refrigerator and watch the position of the bubble in relation to the circle in top of the level.



Place bubble level in bottom of refrigerator



If over 1/2 of the bubble is inside the circle in any direction, the coach is level enough for continuous operation of the refrigerator while parked.



#### CAUTION

To prevent permanent damage to the refrigerator cooling unit, turn the refrigerator off if the vehicle will be parked on an incline of over 3° side-to-side or 6° front-to-rear (such as steep driveways or parking lots, etc.) for more than one hour.

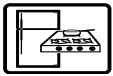

**OPERATING INSTRUCTIONS**

**Norcold Models with Electronic Auto Mode Control**



Push door handle downward and pull to open refrigerator.  
Lift freezer handle upward to open.



Storage locks slide to prop doors open for ventilation during storage periods

**Start-Up Instructions - Gas Mode**

The control panel is located between the freezer compartment and fresh food compartment. It contains pressure sensitive touch switches and LED display. The AC, LP GAS, Battery, and AUTO indicators illuminate to indicate the refrigerator's operating mode.



The ON/OFF button turns the refrigerator On or Off. If the button is pressed, it will turn the refrigerator On and set the mode to AUTO. When the refrigerator is On, pressing this button for 2 seconds will turn the refrigerator Off.

Pressing and holding the MODE button allows the user to cycle through the three mode choices; one AUTO and two manual modes (AC, LP GAS). The refrigerator will not switch to the new operating mode until the mode button is released.

The TEMP SET (thermostat) button controls the refrigerator and freezer temperature during both gas and electric operation. Press and hold the TEMP SET button to select the desired temperature setting. The temperature settings are shown in the form of numbers 1-9. Quickly press and release any button to display the temperature setting.

**Start-Up Instructions - Auto Mode**

When the AUTO mode is selected, the operating control automatically selects the power source using the following priority scheme:

- When 120 volts AC is available to the refrigerator, the AUTO LED and the AC LED will illuminate, indicating the refrigerator is operating on AC electric. After 10 seconds, the AC LED will turn off and only the AUTO LED will remain illuminated. Press and quickly release any button to display the operating mode.
- If 120 volts AC is not available, the refrigerator will switch to the gas operation. The

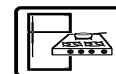

AUTO indicator and the LP GAS indicator will illuminate. After 10 seconds, the LP GAS indicator will turn off and only the AUTO indicator will remain illuminated. Press and quickly release any button to display the operating mode.

During operation in the AUTO mode, when a higher priority power source becomes available, the operating controls will cease using the current power source and will switch to the higher priority power source. For example, if AC electric becomes available while the refrigerator is operating in the AUTO LP GAS mode, the refrigerator will switch to AUTO AC operation.

If an operating mode is not functional, its corresponding indicator will flash and the refrigerator will attempt to operate in a lower power priority source. If a lower power priority source is not available, the indicator will continue to flash, and the refrigerator will cease operation until the energy source is corrected. Refer to the “Diagnostic” section on page 7 of the “Norcold 9100 Series Refrigerators Operator’s Guide” in your blue binder.

## Start-Up Instructions - Manual Mode



To operate the MANUAL mode, press and hold the MODE button until the AUTO indicator disappears and the desired operating mode is displayed. If the power source is interrupted while operating in the MANUAL mode, the

AUTO indicator disappears and the desired operating mode is illuminated. Unlike AUTO mode, the operating mode indicator remains illuminated until an alternate mode is selected. If the energy source is interrupted while in the MANUAL mode, the corresponding indicator flashes, and the refrigerator ceases operation until an alternative energy source is selected or the problem is corrected. Refer to the “Diagnostics” section on page 7 of the Norcold Operator’s Guide in your blue binder for corrective actions.

## AUTO and MANUAL Modes - Gas Operation Only

If the gas does not ignite within 30 seconds, which may occur on initial start-up, the refrigerator’s gas valve will automatically close and the operating controls will select an alternate power source (AUTO Mode) or revert to a stand-by mode in which the LP GAS indicator flashes. The indicator continues to flash until the refrigerator is turned OFF and then ON. If the gas does not ignite after several attempts, check the input gas supply, or consult with your dealer or a Norcold authorized service center. A different mode of operation may be selected by pressing and holding the MODE button. The refrigerator will not switch to the new operating mode until the MODE button is released.

## Backup Operating System (“BOS”)

Your refrigerator features a Backup Operating System which keeps the refrigerator cool in the event of a failure of the refrigerator’s operating controls. If a failure occurs, the TEMP SET indicator flashes and refrigerator switches to the BOS mode. This mode provides refrigeration until the refrigerator is serviced. The fresh food and freezer compartment temperatures should be monitored to prevent over-freezing or thawing of refrigerator contents when operating in the BOS mode. If the refrigerator temperature is too cold, adjust the thermostat to a lower number in single increments. If the refrigerator temperature is too warm, adjust the thermostat to a higher number in single increments. Let the refrigerator operate at the new setting for one hour before rechecking

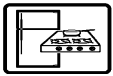

the freezer and fresh food compartment temperatures. (Frequent door opening prevents the temperatures from stabilizing.) Although the refrigerator can operate in this mode, Norcold recommends that you seek service to restore manual operation as soon as practical.

**HUMIDITY - STORAGE SWITCH**

Turning this switch to HIGH HUMIDITY will keep the surface between the door openings dry during high humidity conditions. The switch should be left in the NORMAL OPERATION position unless moisture collects around the door.

When storing your RV for the winter, place this switch in the STORAGE (LIGHT OFF) position. This shuts off all DC power to the light and humidity heater and allows the refrigerator door to be left open for airing without draining the battery.

**Operating Tips**

- The refrigerator should already be cold before placing items in it.
- Food and beverages should also be cold before placing in RV refrigerator. Never put warm or hot items in a cold refrigerator.
- Do not pack the refrigerator too full. The refrigerator needs room for cold air to circulate.
- Use smaller containers for each item. (e.g. a half gallon container of milk instead of a half-full gallon jug)
- Always put foods, especially liquids, in tightly sealed containers.
- Use crumpled paper between loose items to reduce rattling or “clinking” noises.

**Further Information**

For further information and operating cautions, see the Norcold refrigerator operating instructions included either inside the refrigerator or in your InfoCase.

**REFRIGERATOR COMPARTMENT**

**(Exterior)**

The exterior refrigerator compartment allows access to the rear of the refrigerator for inspection, maintenance and service.



Refrigerator Access Compartment

**To Open:**

1. Use a coin to turn the latch knobs to the vertical position as shown.
2. Remove the door from the opening.



Refrigerator Access Door Latches

**To Close:**

1. Replace the door into the opening.
2. Push the latch knobs in while turning to the horizontal position as shown.



**RANGE AND OVEN**

The range and oven in your motor home are operated on LP gas and will provide nearly all of the functions that the range in your home does. The range has a “Pilot Off” position on the oven control which allows the oven pilot to be turned off when traveling or refilling the LP tank.

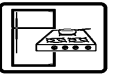

The following warning label has been located in the cooking area to remind you to provide an adequate supply of fresh air for combustion.

**⚠ WARNING**

IT IS NOT SAFE TO USE  
COOKING APPLIANCES  
FOR COMFORT HEATING

Cooking appliances need fresh air for safe operation. Before operation

1. Open overhead vent or turn on exhaust fan.
2. Open window

FAILURE TO COMPLY COULD RESULT IN  
DEATH OR SERIOUS INJURY.

Unlike large homes, the oxygen supply inside a recreational vehicle is limited due to its size. To avoid danger of asphyxiation, provide proper ventilation when using the gas rangetop or gas oven. It is especially important not to use the gas oven and range top for comfort heating. Danger of asphyxiation is greater when these appliances are used for long periods of time.

**⚠ WARNING**

Portable fuel-burning equipment including wood and charcoal grills and stoves, should not be used inside the recreational vehicle. The use of this equipment inside the recreational vehicle may cause fires or asphyxiation.

### Use of Top Burners

1. Light match.
2. Apply lighted match to burner.
3. Turn control knob back left (counterclockwise to the "LITE" position).
4. When the burner lights, adjust the flame height by turning the knob back toward the "OFF" position.

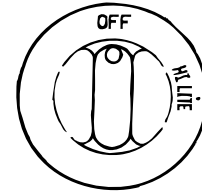

**⚠ WARNING**

Do not turn burner control knob to "On" and allow gas to escape before lighting match.

### Lighting Oven Pilot

*NOTE: If range has not been operated for a long period of time, a longer waiting period for ignition of the pilot may be necessary due to air in the gas line.*

1. Be sure all valves are in the "OFF" Position. The oven control knob should be in "OFF" position.
2. Turn on main gas supply to range.
3. Press and turn control knob to the "PILOT ON" position. This will allow gas to oven pilot.
4. Open oven door and light oven pilot with a match. Small flame will be noted at the

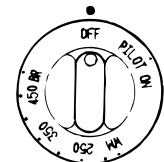

Oven Control Knob in "OFF" position

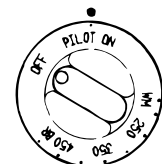

Oven Control Knob in "PILOT ON" position

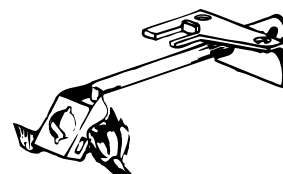

Lighting oven pilot (when pilot is located on left side of burner.)

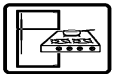

## Operating Oven Control

Push in and turn the oven control knob (counterclockwise) to the desired temperature setting.

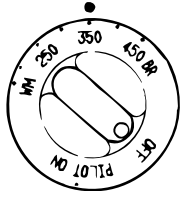

There is a delay of about 45 seconds before the main burner ignites. This is normal and there is no gas escaping during this delay. It is also normal for the oven burner flame to cycle off and on at all temperatures except broil (BR).

### Shut Down Instructions

When oven cooking is finished, turn the oven control knob to the “PILOT ON” position, the oven standby pilot will remain lit.

When the recreational vehicle is not in use or while traveling, turn the oven control knob to “OFF” position and turn off main gas supply; this will turn off the oven pilot.

## MICROWAVE OVEN

For complete operating instructions, refer to the manufacturer’s information provided with the oven.

## RANGE HOOD (Built into microwave)

The range hood vent draws cooking odors and airborne grease particles into the filtration grid and recirculates the air or vents it to the outside of the coach depending on model. A light on the underside of the hood provides better illumination for food preparation. See the manufacturer’s information for instructions on replacement of light bulbs and grease filter elements.

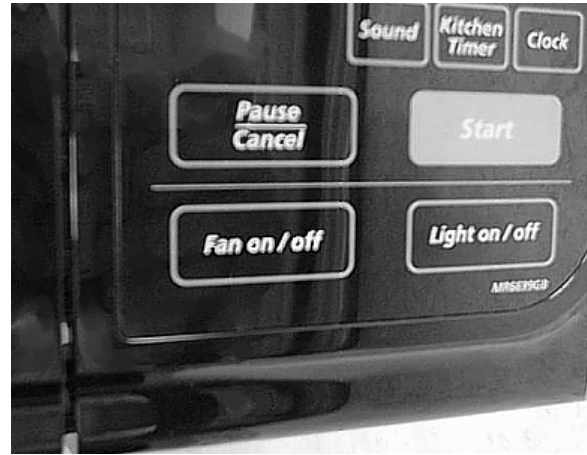

### Hood Fan and Light Switches

To turn on the range hood light, simply press the switch labeled “Hood Light”. To operate the range hood fan, press the “Hood Fan” switch.

## SYSTEMS MONITOR PANEL (Wall Mounted)

The System monitor Panel provides a convenient central location for checking the condition of all utility systems in your coach. At the touch of a button this panel can display the fresh water and holding tank levels, LP gas tank level, plus the engine battery and coach battery condition. You can start the auxiliary generator or turn on the water pump and water heater. Indicator lights tell you if the water pump is on or if the water heater pilot light is out.

At the push of a single button the monitor panel simultaneously displays the coach battery condition and levels of the water tank, holding tanks and LP tank. It also contains the water pump power switch and an indicator light to show when the pump switch is on.



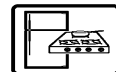

## Water And Holding Tank Levels

Press and hold the “Levels Test” switch to show approximate level on the monitor lights.

These approximate water levels are measured by electronic probes in the sides of the tanks, so the water must be touching a probe to register at that level. There is generally more water in a tank than indicated on the monitor panel.

For example, if the water level of 1-2” below the FULL probe, the monitor will show the level to be only 2/3 even though the tank is nearly full. If the water level is below the 1/3 probe, the monitor will register an empty tank because the water is no longer touching the 1/3 probe. There may actually be some water left in the tank. However, when the indicator reads FULL, the tank is actually full.



## Tank Capacities

See back of “To The Owner” page inside front cover of this manual.

## LP Gas Level

Press and hold the “Levels Test” switch to show approximate LP tank level.

The LP level is registered by a sending unit on the tank. The gauge mounted on the side of the tank will give a more accurate indication of actual tank level if needed.

## Water Pump Switch

When use of the self-contained water system is desired, turn the “Water Pump” switch on. The “Pump On” light will illuminate when the pump switch is on and the system is operable. Water will be available as soon as a faucet is opened. Refer to “Fresh Water System” for additional information on the water pump and initial start-up.



## Battery Charge Meter

Push the “Levels Test” button to check the level of charge (voltage) in the 12-volt coach battery. The colored segments (red, yellow and green) will light from the bottom up to the amount of charge the battery contains.

- \* Green - good or adequate charge.
- \* Yellow - marginal charge.
- \* Red - battery needs charging before use.

To get an accurate reading;

1. Both the chassis engine and the auxiliary generator engine must be shut off.
2. An interior light should be turned on to provide a small load which draws off the battery surface charge.

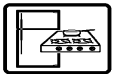

### Generator Start/Stop Switch

See Section 6, Electrical Systems for generator start-up and shut-down instructions.

### Generator Hourmeter

See Section 6, Electrical Systems for generator hourmeter information.

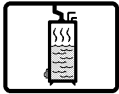

## WATER HEATER

### Direct Ignition Models

**Water Heater Capacity:** 6 gal.

1. Place Water Heater switch in the “On” position. The switch and “WH Pilot” light are located on the monitor panel.



2. If “W.H. Pilot” light stays on longer than 15 seconds, place switch in “Off” position and wait 5 minutes.
3. Repeat step one.
4. If heater fails to operate due to high water temperature, the heater will go into a lockout condition (“W.H. Pilot” light on). When water cools, reset by placing switch in “Off” position for at least 30 seconds, then return to “On” position.
5. If a lockout condition persists: contact your dealer, an Atwood Service Station or Atwood Service Department (Phone: 815-877-5700).
6. For complete shut-down before servicing:
  - a) Place Water Heater switch in “Off” position.

- b) Remove red wire from left-hand terminal of ECO switch (ECO to valve).

### Water Heater Switch and “W.H. Pilot” Indicator

Be sure the water heater is filled with water before pressing this switch. To fill the water heater, turn the water pump switch on and open a hot water faucet until water begins to flow.

The “W.H. Pilot” light will glow for about 10-15 seconds after the water heater switch is turned on, then it will go off.

If the “W.H. Pilot” light comes on during normal operation, it means that the burner has gone into “lockout” mode. Turn the switch off for about 5 minutes, then turn back on.

### Pressure-Temperature Relief Valve

On occasion, water may be seen seeping from the water heater pressure temperature relief valve. This is no cause for repair or replacement of the valve.

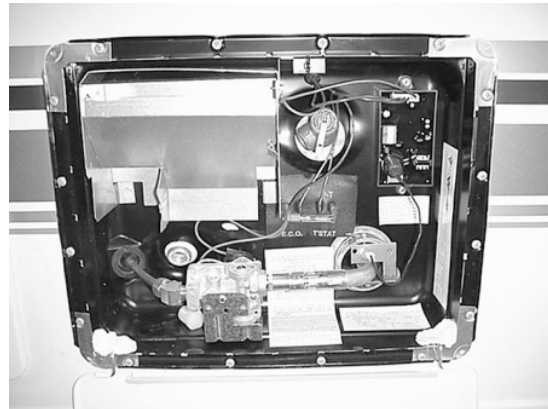

#### Water Heater Exterior Service Access

Normally there is an air gap at the top of the water heater tank which acts as a pressure buffer. In time, however, heated water may expand and fill this air gap, causing a slight increase in water pressure. This may cause the P-T valve to “weep” until the air gap is manually replaced.

**OPERATE THIS VALVE ONLY WHEN THE WATER HEATER AND ENGINE COOLING\* SYSTEM ARE COLD!**

To Replace the Air Gap:

1. Turn off the water heater switch and incoming water supply (city water and/or demand pump).

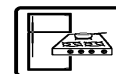

2. Open a faucet in the motor home to relieve water pressure.
3. Pull the handle of the P-T valve straight out and allow water to flow until it stops.



Lift handle straight out to open P-T valve

4. Let the handle of the P-T valve snap shut.
5. Close the faucet and turn on the water supply before switching the water heater on.

Manually operate the pressure temperature relief valve at least once a year.

\*If your water heater is equipped with the optional Motor Aid system, it uses an extension from the engine cooling system to heat water in the water heater while driving. The engine cooling system must also be cold before opening the pressure-temperature relief valve. See “Motor Aid” on following page for more information.

## Water Heater By-Pass Valve

Your coach may be equipped with a water heater by-pass valve for easier winterization of water lines using RV antifreeze. The valve is located inside the coach near the water heater. See pg. 7-7 or 7-8 for the exact location in your coach.

Turn the handle as shown to either by-pass or flow through the water heater.



## CAUTION

Leave by-pass valve handle in NORMAL position if draining water and blowing out water lines. Place in BYPASS position ONLY when using antifreeze solution in water lines.

## MOTOR AID

The motor aid uses heat from the chassis engine cooling system to heat water in the water heater while driving. Hoses are routed from the engine to a heat exchanger surrounding the water heater tank.

Under normal conditions, the entire contents of the water heater can be heated to about 140°F in about two hours or 100 miles of driving. This means you can have hot water at the faucets immediately upon arriving at a site, or even while driving if needed.

The motor aid also increases the capacity of the engine cooling system, allowing the engine to run cooler under many conditions.



## CAUTION

Any leak in the heat exchanger or its supply or return lines could cause loss of coolant and subsequent engine failure. We recommend that you periodically inspect these connecting lines and the heater to insure that no leaks have developed.

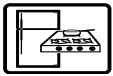

### Motor Aid Water Heater and Rear Auxiliary Heater Maintenance

Have your authorized dealer check all hose clamp connections on the rear automotive heater and the motor aid water heater at least every six months and tighten them if necessary.

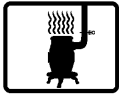

### LP GAS FURNACE (SUBURBAN)

#### Start Up:

1. Open the LP gas tank valve by turning fully counterclockwise.

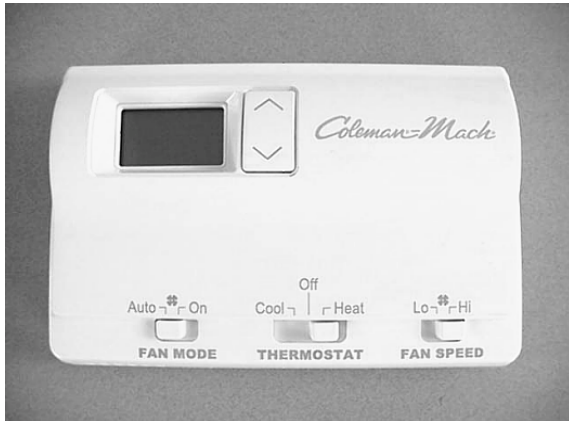

2. Move THERMOSTAT switch from Off to Heat and press the Temp Selector button (Up/Down arrows) until the desired temperature is shown in the display.
3. Furnace fan will start to blow immediately after setting thermostat.
4. After about 30 seconds, the furnace burner will light.
5. The furnace will now cycle off and on automatically as the thermostat demands just like a household furnace.

*NOTE: Metal coatings used during manufacture of the furnace burner parts may smoke when the furnace is used for the first time, which may also set off your smoke alarm. If this happens, provide adequate ventilation of the smoke to avoid a nuisance smoke alarm at this time. We do*

*not recommend removing the smoke alarm battery. If it were inadvertently left disconnected, the smoke alarm would be inoperative.*

#### To Shut Down:

1. Slide thermostat switch to OFF position.
2. Close LP tank valve.

*NOTE: If heat does not come out of the heat ducts after a minute or so the burner is not lit. Turn thermostat off for 3-5 minutes, check to be sure tank valve is open and tank is not out of fuel, then try steps 2-4 again. If it still will not light after three attempts, go to Shut Down steps and contact your dealer or a local RV service center.*

#### For Further Information

Please see the Suburban furnace operating instructions provided in your Owner InfoCase for further information, including operating precautions, and periodic maintenance.

#### HEAT PUMP - Optional

Your coach may be optionally equipped with an air source heat pump built into the air conditioning system. Because the heat pump operates on electricity, it provides economical heat inside your coach and helps reduce the use of LP gas for heating in cooler weather.

A heat pump can be thought of as an air conditioner running in reverse. An air conditioner absorbs heat from the air inside of the coach and moves it to the outside. The heat pump does exactly the opposite. Even cold air contains some heat, so a heat pump will extract heat from the outside air on a cold day and carry it to the inside of the coach to maintain a comfortable temperature.

The efficiency of a heat pump decreases as the outdoor air temperature drops, so supplementary heat is often needed when the outside temperature nears freezing. This system is set to automatically start the LP gas furnace to assist the heat pump if room temperature cools to 5 degrees or more below the thermostat set temperature. You may wish to manually switch to furnace heat to maintain a higher temperature when outside temperatures begin to reduce the efficiency of the

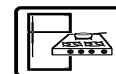

heat pump. The heat pump will not operate when the outside temperature falls below 36 degrees F.

### To operate the heat pump:

- Slide the Thermostat switch to Electric heat mode.
- If the inside temperature is 5 degrees or more below the thermostat set point, both the heat pump and the furnace will run initially to bring the interior temperature up to the set point as quickly as possible. (If the inside temperature is 4 degrees or less below the set point, then only the heat pump will run initially.)
- When the thermostat is satisfied, the heat pump and furnace will both shut off.
- When the thermostat calls for heat again, only the heat pump will run. The heat pump will remain the sole heat source unless it cannot maintain the inside temperature. If the inside temperature falls five degrees below the set point, the furnace will assist the heat pump until the set point is reached.

If the furnace must assist the heat pump three times in a row, the thermostat will shut down the heat pump for two hours and the furnace will take over as the heat source. After two hours the heat pump will become active again and try to be the primary heat source.



Gas Heat = Gas Furnace  
Electric Heat = Heat Pump

### DUCTED ROOF AIR CONDITIONING SYSTEM

Front and rear air conditioner units are controlled by separate wall thermostats. The front thermostat is located on a galley wall. The rear thermostat is located in the bedroom.

The front thermostat also controls furnace operation when the SYSTEM switch is placed in HEAT position. (See LP Gas Furnace).

The rear bedroom thermostat controls the rear air conditioner only and does not have HEAT position unless equipped with the heat pump option.

*NOTE: These thermostats are equipped with a replaceable 2 Amp fuse located on the back of the thermostat body.*

See “Air Conditioner Selector Switch” on page 8-11 for instructions on using two roof air units at once, if equipped. See also “Powerline EMS” on page 6-2.

Refer to the manufacturer’s information in your InfoCase for complete operating instructions.

*NOTE: The ducted roof air conditioning system has ceiling registers that can be closed if necessary to force more cool air toward a specific area of the coach or to route cool air away from a specific area. If too many vents are closed, however, it can cause the air conditioner unit to shut down particularly in high humidity conditions.*



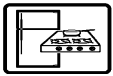

**Operation**

The following chart shows the system functions with the “Heat/Cool” thermostat. Disregard references to heat functions when using the “Cool Only” thermostat in the rear bedroom.

| ■ SHOWS POSITION OF SWITCH          |                                     |                                     |                                     |                                     |                                     |                                     |                                     | OPERATION  |
|-------------------------------------|-------------------------------------|-------------------------------------|-------------------------------------|-------------------------------------|-------------------------------------|-------------------------------------|-------------------------------------|--|
| * SYSTEM                            |                                     |                                     |                                     | AUTO FAN                            |                                     | ON                                  |                                     |  |
| HEAT                                | COOL                                | OFF                                 | FAN                                 | HI                                  | LO                                  | LO                                  | HI                                  |  |
| <input type="checkbox"/>            | <input type="checkbox"/>            | <input checked="" type="checkbox"/> | <input type="checkbox"/>            | <input type="checkbox"/>            | <input type="checkbox"/>            | <input type="checkbox"/>            | <input type="checkbox"/>            | No functions occur.  |
| <input type="checkbox"/>            | <input type="checkbox"/>            | <input type="checkbox"/>            | <input checked="" type="checkbox"/> | <input type="checkbox"/>            | <input type="checkbox"/>            | <input type="checkbox"/>            | <input type="checkbox"/>            | Air conditioner fan runs at high speed continuously regardless of fan switch setting or setpoint. No other functions occur.  |
| <input type="checkbox"/>            | <input checked="" type="checkbox"/> | <input type="checkbox"/>            | <input type="checkbox"/>            | <input checked="" type="checkbox"/> | <input type="checkbox"/>            | <input type="checkbox"/>            | <input type="checkbox"/>            | Air conditioner compressor, high speed fan and furnace high speed (if so equipped and wired), cycle to satisfy setpoint.   |
| <input type="checkbox"/>            | <input checked="" type="checkbox"/> | <input type="checkbox"/>            | <input type="checkbox"/>            | <input type="checkbox"/>            | <input checked="" type="checkbox"/> | <input type="checkbox"/>            | <input type="checkbox"/>            | Air conditioner compressor, low speed fan and furnace low speed (if so equipped and wired), cycle to satisfy setpoint.   |
| <input type="checkbox"/>            | <input checked="" type="checkbox"/> | <input type="checkbox"/>            | <input type="checkbox"/>            | <input type="checkbox"/>            | <input type="checkbox"/>            | <input checked="" type="checkbox"/> | <input type="checkbox"/>            | Air conditioner compressor cycles to satisfy setpoint. Air conditioner low speed fan and furnace low speed fan (if so equipped and wired) run continuously.  |
| <input type="checkbox"/>            | <input checked="" type="checkbox"/> | <input type="checkbox"/>            | <input type="checkbox"/>            | <input type="checkbox"/>            | <input type="checkbox"/>            | <input type="checkbox"/>            | <input checked="" type="checkbox"/> | Air conditioner compressor cycles to satisfy setpoint. Air conditioner high speed fan and furnace high speed fan (if so equipped and wired) run continuously.  |
| <input checked="" type="checkbox"/> | * <input type="checkbox"/>          | <input type="checkbox"/>            | <input type="checkbox"/>            | <input checked="" type="checkbox"/> | <input type="checkbox"/>            | <input type="checkbox"/>            | <input type="checkbox"/>            | Furnace and furnace high speed blower cycle to satisfy setpoint. Furnace blower operates from sequencer or time delay in furnace. During furnace operation, furnace overrides and forces fan to high speed. Air conditioning fan does not run. |
| <input checked="" type="checkbox"/> | * <input type="checkbox"/>          | <input type="checkbox"/>            | <input type="checkbox"/>            | <input type="checkbox"/>            | <input checked="" type="checkbox"/> | <input type="checkbox"/>            | <input type="checkbox"/>            | Furnace blower runs continuously at low speed (if so equipped and wired) until furnace cycles on to satisfy setpoint. Furnace overrides and forces fan to high speed during furnace operation. Air conditioning fan does not run.              |
| <input checked="" type="checkbox"/> | * <input type="checkbox"/>          | <input type="checkbox"/>            | <input type="checkbox"/>            | <input type="checkbox"/>            | <input type="checkbox"/>            | <input type="checkbox"/>            | <input checked="" type="checkbox"/> | Furnace blower runs continuously at high speed (if so equipped and wired). Furnace cycles to satisfy setpoint.   |



**TV ANTENNA**

The TV antenna on your motor home can be easily raised, rotated a full 360° and lowered from inside the vehicle by simply turning a crank or rotating knob. A built-in signal amplifier designed to strengthen signals, is controlled by a power switch built into the TV jack assembly.

The signal amplifier is housed inside the antenna with the circuit board connected directly to the antenna elements. Power to operate the amplifier (12-volt DC) is supplied through the download cable which also carries the TV signals to the TV set. The power supply separates the 12-volt DC from the TV signals and provides a place for attaching the TV set and the 12-volt power source.

**OPERATION**

**Raising Antenna** - Turn elevating crank clockwise in “UP” direction about 13 turns or until some resistance to turning is noted. Antenna is now in operating position. Turn amplifier power switch “ON” to receive TV signal.



**WARNING**

This symbol is used to alert you to precautions that involve your personal safety as well as vehicle damage. Read and follow them carefully.

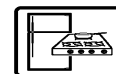

**Rotating Antenna** - Make sure antenna is in the “UP” position. Pull down on rotating knob until it disengages ceiling plate and rotate for best picture and sound on TV set.



**Lowering Antenna to Travel Position** - Rotate antenna until pointer on rotating knob aligns with pointer on ceiling plate.

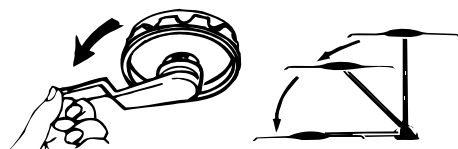

**⚠ CAUTION**

Never leave the antenna partially raised or partially lowered. This can damage the crank mechanism gears. Always raise the antenna straight up or lower it completely into the travel position.

Turn elevating crank (counterclockwise) in “DOWN” direction until resistance is noted. Antenna is now locked in travel position. Turn amplifier power switch “OFF”.

Count the number of turns needed to crank the antenna down to the roof of the unit (normally about 13). Mark the final position of the crank handle on the ceiling or the directional knob for reference. Also mark the number of turns needed. Use the mark and number as a reference whenever you lower the antenna.

**⚠ CAUTION**

Always align directional handle to “DOWN” position before lowering.

### SIGNAL AMPLIFIER

The amplifier power switch is located on the video selector system panel in the driver’s compartment overhead cabinet.

To operate amplifier, turn on power switch.



Other TV jack plates are mounted in various locations throughout the coach. Some of these wall plates are not readily visible and may be in one of the following locations.

- In the flip-down entertainment tray on the outside of the coach.

### Checking Signal Performance

The TV signals available to an RV are entirely dependent on its location in relation to the transmitter. Signals may vary from strong to no usable signal at all. We recommend that the TV system be checked out in an area known to have good TV reception.

To check the antenna amplifier, raise the antenna, select a TV channel and rotate the antenna

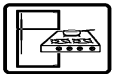

**SECTION 8**  
**APPLIANCES & INTERIOR FEATURES**

**BR AVE**

for best picture. Then turn off the amplifier power switch. If the antenna amplifier is working properly, the TV picture will now be degraded (snowy). When you turn the switch back on, the picture should again be sharp.

**CHECKING PERFORMANCE**

The TV signals available to an RV are entirely dependent on its location in relation to the transmitter. Signals may vary from strong to no usable signal at all. We recommend that the TV system be checked out in an area known to have good TV reception.

To check the antenna amplifier, raise the antenna, select a TV channel and rotate the antenna for best picture. Then turn off the amplifier power switch. If the antenna amplifier is working properly, the TV picture will now be degraded (snowy). When you turn the switch back on, the picture should again be sharp.

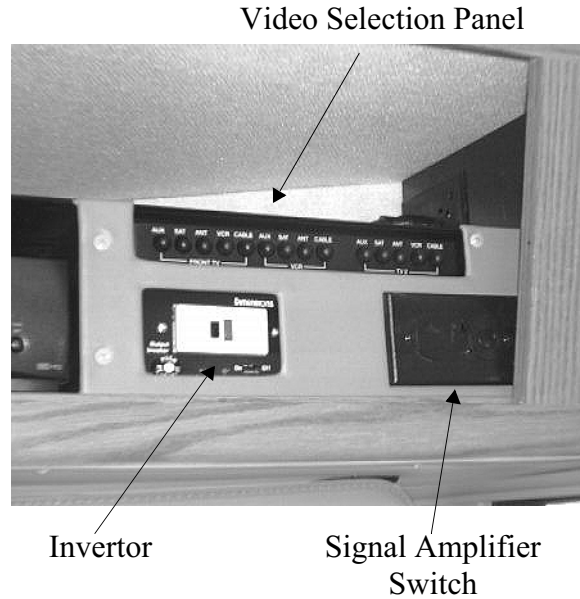

**Components**

- TV1 = Front TV
- TV2 = Bedroom TV
- VCR = Videocassette Recorder

**Signal Inputs:**

- ANT - Press to connect selected TV or VCR to the roof antenna.
- AUX - Press to connect selected TV or VCR to cable TV input.
- VCR - Press to connect selected TV to the videocassette recorder/player.

**Digital Satellite System Wiring**

The roof of your coach is pre-wired with coaxial cable and elevation sensor wiring for later installation of a Digital Satellite System (DSS) if you wish to add one. Hook up jacks are located in the left or right front overhead compartment, depending on model. See your authorized Winnebago Industries dealer for proper sealing of roof mounted components.

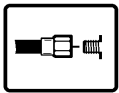

**CABLE TV HOOK-UP**

Some models are equipped with external connections for cable television. The connector is located in the shoreline cord compartment.



**VIDEO SELECTION CENTER**

The video selection center allows you to switch the antenna, cable TV or VCR signal to any TV set location in the coach.

This means one person can watch a ball game coming in on the roof antenna on the bedroom TV while another person watches a cable TV program or a video tape on the VCR on the front TV. Also, two people can watch different programs on the two TV's while taping a third program on the VCR.



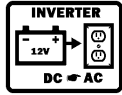
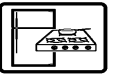

## DC-AC ELECTRICAL VOLTAGE INVERTER - Optional

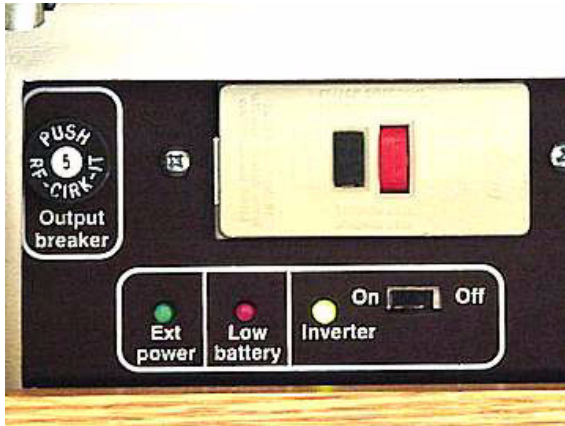

The voltage inverter changes 12 volt DC current into 110 volt AC current to operate your TV and VCR while traveling or when shoreline hookup is not available.

- The inverter must be switched on to operate.
- Turn the inverter off when not in use to avoid draining the coach or automotive batteries.

## EXTERIOR ENTERTAINMENT CENTER

The optional exterior entertainment center contains a stereo radio with cassette player or CD and convenient TV hook-ups for your outside listening or viewing pleasure.



Exterior Entertainment Center

## SLEEPING FACILITIES



### WARNING

Do not use sleeping facilities while vehicle is moving.

## DINETTE/BED CONVERSION

### To Convert Dinette to Bed:

1. Lift the seats and remove the seat support 'bumpers' to allow the seats to lie flush for use as a bed. Do not lose bumpers because you must refit them when reverting back to dinette seat configuration.

Remove 'bumpers' from seat frame when converting to bed to allow seat to lie flat. Replace when returning to dinette seating.



2. Release the catch on the table leg brace and fold the leg up against the bottom of the table.



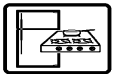

3. Remove the table from the wall support bracket by lifting the end of the table. Then lower the table to rest on the cleats attached to each dinette bench.



4. Arrange dinette cushions to cover bed area.

**To Revert to Dinette:**

1. Replace the table onto the wall support and lower the table leg.
2. Make sure that the table leg is secured into the floor support bracket and the leg brace is locked.



**COUCH BED CONVERSION**

**To Convert Couch to Bed:**

Pull the front edge of the couch seat upward and outward from the wall while gently pushing downward on the backrest until the cushions lie flat. The bed is now ready for use.

**To Revert to Couch:**

Push the front edge of the seat toward the wall while lifting upward on the backrest until the couch is fully seated against the wall.



**Rest Easy™ Multi-Position Lounge - Optional (If equipped)**



**To Recline:** Press the bottom side of the switch on the front of the armrest. Push the top side to return to upright position.

|  |                |
|--|----------------|
|  | <b>CAUTION</b> |
| Do not recline the lounge completely flat unless the footrest section is extended. |                |



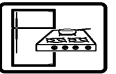

### To Extend Pull-Out Footrest Section:

Reach through the 'dip' opening in the center of the lounge front as shown. Squeeze the latch on the inside of the lower face panel and pull the lower 'trundle' section of the lounge outward until fully extended. The gap between the footrest and seat provides ample room to enter and exit the lounge. If desired, however, the footrest section can be pushed against the lounge seat.



Pull the loop grab handle and lift the trundle footrest section up and outward from the sofa (toward you) until the footrest section is in the fully raised position.

**To Convert to Bed:** Extend footrest section and push together with lounge seat cushion, then press recline button until entire lounge lies flat. Reverse steps to revert to lounge.



**Tip for "power users":** If you have the footrest section positioned against the seat cushion, it will move out with the lounge when you press the recline switch. When you return to upright position, hook your heels over the front edge of the footrest section and pull it back with you. Then, when you want to get up, simply push the footrest section forward with your feet to provide a gap for you to exit.

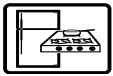

**WARNING**

To avoid injury to young children, do not allow them to operate the sofa, or to play within the sofa or near the operating mechanism.



**Hoop Chair Mount**

The hoop base of lounge chair is mounted to the floor with a clamp as shown.



**CAUTION**

The chair must be clamped back into place before driving the coach.

The clamp knob can be unscrewed and removed to allow you to position the chair as you desire in the living area of the coach.



**FRESH WATER TOILET**

The fresh water toilet in your motor home is very similar to the household type, except that it is designed to use only a small amount of water per flush. It uses a high velocity jet of water, producing a swirl effect, to efficiently cleanse the bowl. And since each flush uses fresh water, no special chemicals are required other than a deodorizing agent, if necessary.

**Thetford Toilet**

1. Press the pedal and hold until bowl is clean. Release pedal slowly. A small amount of water will remain in the bowl.

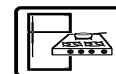

- To add more water to the bowl than the normal 2" automatic refill, lift the pedal and hold until desired amount has been added. Release pedal slowly.



Please refer to the manufacturer's information supplied with the toilet for further operating and maintenance instructions.

### Important "Don'ts"

- Don't use facial tissue or regular toilet tissue in the RV toilet. These will not disintegrate sufficiently and will often cling to the sides of the holding tank. Toilet tissue made specifically for use in RV toilets and holding tanks is available at most RV supply centers.
- Don't dispose of sanitary napkins or other non-dissolving items in the toilet.
- Don't put automotive antifreeze or caustic chemicals, such as laundry bleach or heavy detergents into the toilet or holding tank. These products may damage plastic or rubber parts in the system.

### CLEANING THE TOILET

The toilet should be cleaned regularly for maximum sanitation and operating efficiency. If an odor is apparent from the toilet:

- Clean the toilet bowl with a mild bathroom cleaner. Do not allow cleaners to set in the bowl for long periods of time to avoid damaging the seals. Do not use caustic or abrasive cleaners because it may damage the plastic surfaces.
- Dump and rinse holding tank.
- Add odor control chemical in amount specified after cleaning and every few days during use.

- Remove the water line from the base of the toilet and clean the screen.
- If the flush valve becomes stiff after extended use, it may be lubricated with a silicone spray. Turn the water pump off and operate flush pedal to drain water from the toilet bowl. Spray silicone lubricant onto flush valve inside bowl and operate flush pedal a few times to ensure free operation.

See instructions in Section 10 to prepare the toilet for storage in freezing conditions.

### POWER ROOF VENT - Bath Area

Some models are optionally equipped with a powered roof vent in the bath area. A push button switch for the vent fan is located up on the vent. The vent dome can be raised and lowered using the crank handle.

### CRANK-OUT SIDE WINDOWS

Turn the crank-out knob clockwise to open window; counterclockwise to close. Do not use excessive force on the knob to open or lock into closed position. This could cause permanent damage to the crank mechanism.

When closing the window, crank the window in snugly, then back off 1/4 turn to help avoid glass warping which can result in wind noise.



If the window will not open after three or more full turns of the knob, the glass may be stuck to the sealing gasket. Go to the outside of the coach and gently free the glass with your fingers. A periodic light dusting of talcum powder on the gasket should prevent this from recurring.

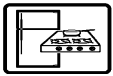

## SLIDER WINDOWS

Lift the latch handle straight out from the window. Grasp the sliding window edge frame and slide the window to the side. Be sure the latch is raised before trying to slide the window closed.



*To loosen the tension, unwrap the guide cords from the spools one turn at a time until desired tension is achieved.*

## DAY/NIGHTER PLEATED BLINDS

Your coach may feature two-stage pleated window blinds that can be used for daytime or nighttime privacy.

**Sun Filter:** The first, lower section is a translucent white shade that can be lowered for privacy without darkening the inside of the coach. It can also filter out harsh direct sunlight to help keep the inside of the coach cool in summer or to disperse light for houseplants.

**Room Darkening/Privacy Shade:** The second, upper section is an opaque, darkening shade for nighttime privacy and daytime room darkening purposes. Pull both the first and second sections down together or separately.

### Tension Adjustment:

The tension of the pleated blinds can be adjusted if they become loose and will not stay up when raised, or they are too tight and are difficult to raise and lower.

*To tighten the tension, simply wrap the lower end of the guide cords (on each side of the shade) a few turns around the spools at the lower corners of the blinds.*

We recommend that you fully raise pleated blinds when they are not needed, especially in warm environments, to prevent them from losing their shape.

## QUARTZ WALL CLOCK

### To Replace Battery

The clock is mounted in a socket on the face of the cabinet.

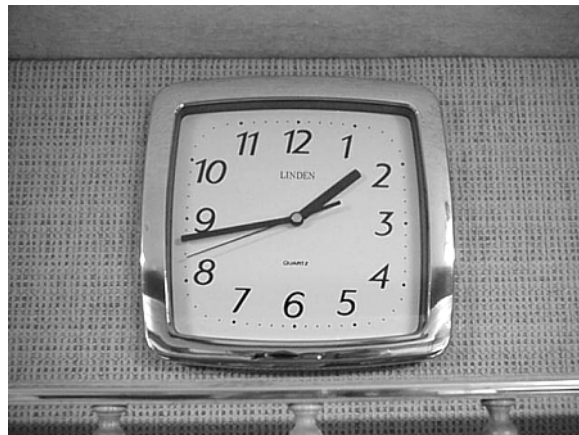

Carefully remove the clock from the socket by rotating to the left (counterclockwise) as shown.

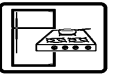

After replacing the battery, simply place the clock back into the socket with 12 at the 9 o'clock position and rotate upright.

---

## COFFEE MAKER - Optional

The manufacturer's instructions for use and care are included in your operation manual binder.

### To Remove for cleaning:

- Unplug the coffee maker from the electrical receptacle and remove the carafe (pot) from the burner plate.
- Pull the coffee maker unit firmly outward until it unlatches from the detents (snap notches) in the slide mount.

### To Replace after cleaning:

- Angle the coffee maker unit upward slightly to start it into the slide mount.
- Push the unit straight back all the way into the slide mount.
- Press the sides of the slide bracket until you hear and feel them "click" into place.
- Plug the coffee maker unit back into the electrical receptacle.







### CAUTION

Sealants must be inspected every 6 months and resealed if necessary.

### ROOF

The roof is made of Thermo-Panel materials like the walls and floor. It will support the weight of an average adult should it become necessary to repair the roof or roof mounted components. It is not recommended, however, that very large or heavy objects be carried on the roof while the vehicle is in motion. (See page 4-1 for roof loading specifications.) Always have damage to the roof area repaired immediately. Damaged or detached sealant around the vents, air conditioner, body-to-roof seams, etc., should also receive immediate attention. Delaying these repairs may allow water leakage and result in damage to interior ceiling and body panels, upholstery, etc.

### UNDERBODY

Buildup of mud and dirt under the body can cause damaging rust on steel parts and can add needless weight to the vehicle. This, in effect, reduces the amount of cargo you can carry and remain within GVWR and GAWR limits.

Corrosive materials, such as those used for ice and snow removal and dust control, also accumulate on the underside of a vehicle. These materials should be removed by flushing the underbody regularly with water, especially areas where mud and other foreign materials collect.

### EXTERIOR

The exterior surface of your motor home has an automotive finish. Frequent washing and thorough cleaning is recommended to prevent damage to the vehicle finish after exposure to damaging salts, calcium chloride, road tar, tree sap, insects and other foreign material. Never wash the vehicle in direct sunlight, while the vehicle surface is hot, or using hot water.

Do not use strong soaps or detergents for washing the motor home. Always use a mild soap in warm water, a commercially prepared product

for cleaning automotive finishes or your local car wash. Be careful when using pressure-type washers to avoid loosening exterior decals or sealants, etc.

*NOTE: Avoid aiming water flow from a hose or spray from high pressure washing equipment into any appliance intake or exhaust vents, which could cause damage or difficulty in operating appliances.*

After washing the motor home, carefully inspect caulking around window frames and vents and any other joints that may have separated. Re-caulking, if necessary, is quite simple. Appropriate compounds are sold at Winnebago and Itasca dealers, and the materials are quickly and easily applied. Also, inspect weather seals around door, etc., and if necessary have a dealer replace them immediately.



### CAUTION

Never use a strong solvent such as lacquer thinner, or harsh abrasives on painted surfaces.

### Care of your Gelcoat Fiberglass Finish

You can keep the gelcoated fiberglass exterior finish of your coach looking good for years to come with a minimum of care. The smooth automotive finish is as easy to care for as your car's - just wash regularly and wax as needed.

### Washing

Regular washing with a soft brush, mild soapy solution and water will keep it clean - and keep black streaks from forming.

### Waxing

A high-grade automotive wax used as needed will restore Performance Plus' original luster and color. It is best to wax at least every spring and fall, more often if your RV is frequently exposed to extreme sun, smog, soot or other environmental pollutants.



## Stains and Discolorations

Regular cleaning and waxing will help prevent most discolorations and stains; however, please be aware that using caustic, highly alkaline cleaners or any cleaner with ammonia may actually darken your RV's exterior. If stains or discolorations do appear, they can be removed by gently wet-sanding the discolored area with a fine grit sandpaper and then using an electric or pneumatic buffer and a liberal amount of rubbing compound. Finishing with an automotive wax will restore the gelcoat's original luster.

*NOTE: Your Winnebago Industries RV dealer is equipped and trained to handle this type of work. We advise you see him before attempting this yourself.*

## Scratches

Although the gelcoat exterior is very scratch resistant, scratches may occur occasionally. Those that haven't penetrated too deeply can usually be rubbed out with an automotive polishing compound applied with a power buffer or by hand. Not all scratches disappear completely, but they will be less noticeable. After using the polishing compound, you should then wax your RV to seal the surface. This will enhance the gelcoat's gloss and color and prevent stains. It is best to let your Winnebago Industries RV dealer evaluate the situation before using an automotive polishing compound.

## When Accidents Happen, Repairs are Easy

If a mishap causes a gouge or chip in your RV's gelcoat exterior, it can be repaired nearly anywhere, whether you are at home or on the road. Most Winnebago Industries RV dealerships have repair shops staffed with employees skilled in repairing gelcoat, or they can refer you to a body shop equipped to handle these repairs. Either way, your RV should come out looking like new.

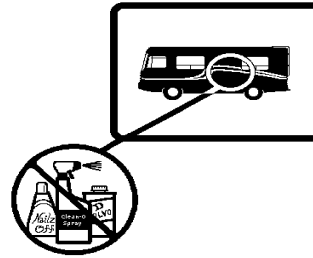

## Care of Stripes and Decals

The pressure-sensitive decals on your coach require very little maintenance. They should be treated like any painted surface on your vehicle. Here are a few helpful hints on caring for decals:

- Wash decals with plain soap and water or any retail car wash soap. Always rinse thoroughly.
- Keep high-pressure wash nozzles at least 18 inches from edge of decals. High pressure water spray may cause edge lifting of decals.
- Test any cleaning solution on a small section of decal before using.
- Do Not use any aromatic solvents such as acetone, MEK, toluene, xylene, etc., on decals. Any solvent including alcohol may soften or smear colors.
- Do Not use lacquer thinner on paint or decals. Do Not overcoat decals with clear paint.
- Do Not let gasoline or other fuels drip and stay on decals for any length of time. Rinse immediately.

## UPHOLSTERY, CARPETING AND DRAPERIES

We recommend a weekly routine of vacuuming all fabrics and carpet throughout the motor home to prevent an accumulation of dirt which can detract from the appearance and shorten the life of carpet and fabrics.

### Carpet Care & Cleaning

See the carpet manufacturer's Carpet Care Guide in your InfoCase. It includes detailed information on cleaning soils and removing stains from the fine carpet in your coach.

### Upholstery

Some fabrics used in this motor home may contain fire retardant and lightfastness additives which can be damaged by use of improper clean-



ing products. Some water-based household cleaning products are not formulated for use on fabrics and may cause excessive shrinkage or fading. Always test any cleaning product on a hidden area of fabric before using on visible areas. For best results, fabric cleaning should be referred to a professional carpet and upholstery cleaner.

*NOTE: To minimize fading of upholstery, carpets and other interior fabrics caused by excessive sunlight, the drapes, blinds or shades should be closed when the motor home is parked for an extended period of time.*

|  |
|--|
|  <b>WARNING</b>   |
| When cleaning upholstery and fabric, do not use lacquer thinner, nail polish remover, laundry soaps, or bleach. Never use carbon tetrachloride, gasoline, or naphtha for any cleaning purpose. These materials may cause damage to the material being cleaned and most are highly flammable. |

### Spots and Stains

Spots or stains should be treated as soon as possible before they “set in” to avoid permanent damage. Always start from the outside of a spot or stain and work inward to avoid spreading it. Use a clean cloth or sponge and turn frequently to an unused area of the cloth or sponge as you clean.

Some stains or soils, such as lipstick, ink, grease or mustard, are extremely difficult or impossible to remove completely and should receive immediate attention. Consult a professional carpet and upholstery cleaner for assistance.

### Leather Upholstery - Driver/Co-Pilot Seats & Sofa - (Optional)

The optional leather seats are made of top quality cattle hide soft leather.

- We recommend using a mild soap and water applied gently to the soiled areas. Buff dry immediately with a soft cloth to avoid water spotting. Avoid harsh and excessive rubbing while cleaning. Soft leather needs delicate care.
- Never use harmful substances (e.g. stain removers, solvents, saddle soap, shoe polish or other unsuitable fluids) on soft leather. Cleaning and touch-up kits specifically formulated for leather upholstery are available from most fine furniture dealers.

### Vinyl

Vinyl should be cleaned with a soft, damp cloth, and a mild detergent only. Do not use solvents. Solvents may damage the surface of the vinyl.

### Draperies, Curtains and Bedspreads

These items may be woven from a variety of fabrics. We recommend that these be professionally dry cleaned only. A five percent shrinkage may occur when you have these items dry cleaned.

### Care of Ceiling Fabric

While using your coach, your ceiling fabric may become soiled and require spot cleaning from time to time. The following information is provided as a guideline for care and cleaning of ceiling fabrics used in your coach. (See cleaning chart on following page.) These materials are made from polypropylene or polyester synthetic fibers, so they clean very well with virtually no damage to the color or fabric itself.

Most commercially available carpet and upholstery cleaners will do an excellent job removing stains. From time to time, additional cleaning methods may need to be used to remove stubborn or difficult stains.

### General Stains

As with any stain or contamination, the quick response is the best, especially when done in conjunction with the proper cleaner for the type of stain.



**IMPORTANT:** Make sure you have selected the right cleaning agent from the list below before you begin the cleaning process.

**NOTE:** In many cases listed in the chart below, repeated steps may be required to fully extract contaminant from material. Items listed with (\*) may also be removed through steam extraction method by a professional cleaner or service. Always check to see that the cleaner used will not cause damage to the material or fabric by testing on an area out of sight.

| Type of Stain          | Cleaning Agent                        | How to Remove                               |
|------------------------|---------------------------------------|---|
| Mustard                | Dry-Clean Solvent                     | Scrub-Soak-Blot Dry                         |
| Ketchup*               | High Strength Detergent               | Scrub-Soak-Blot Dry                         |
| Coffee*                | High Strength Detergent               | Scrub-Soak-Blot Dry                         |
| Chocolate*             | Detergent                             | Scrub-Soak-Blot Dry                         |
| Tea                    | High Strength Detergent               | Scrub-Soak-Blot Dry                         |
| Chewing Gum            | Dry-Clean Solvent                     | Scrub-Soak-Blot Dry                         |
| Oil                    | High Strength Detergent               | Scrub-Soak-Blot Dry                         |
| Grease                 | High Strength Detergent/<br>Degreaser | Scrub-Soak-Blot Dry                         |
| Tar/Asphalt            | K-1 Kerosene/Thinner                  | Scrub-Soak-Blot Dry                         |
| Wax                    | Detergent                             | Hot Iron on Detergent-Soaked Towel or cloth |
| Rust                   | Rust Remover                          | Scrub-Soak-Blot Dry                         |
| Dirt*                  | Detergent                             | Scrub-Soak-Blot Dry                         |
| Lipstick               | Dry-Clean Solvent                     | Soak-Blot Dry                               |
| Nail Polish            | Dry-Clean Solvent                     | Soak-Blot Dry                               |
| Shoe Polish            | Dry-Clean Solvent                     | Soak-Blot Dry                               |
| Crayon                 | High Strength Detergent               | Scrub-Soak-Blot Dry                         |
| Marker (indelible)     | Detergent                             | Scrub-Soak-Blot Dry                         |
| Ink (Ballpoint Pen)    | Dry-Clean Solvent                     | Soak-Blot Dry                               |
| Pencil Lead (Graphite) | Detergent                             | Scrub-Rinse-Blot Dry                        |
| Vomit*                 | High Strength Detergent               | Scrub-Rinse-Blot Dry-Deodorize w/Vinegar    |
| Urine*                 | High Strength Detergent               | Scrub-Rinse-Blot Dry-Deodorize w/Vinegar    |
| Blood*                 | High Strength Detergent               | Scrub-Rinse-Blot Dry                        |
| Excrement*             | High Strength Detergent               | Scrub-Rinse-Blot Dry-Deodorize w/Vinegar    |

**Water Stains**

Water stains should be cleaned with a mixture of 1/4 cup of white laundry detergent in a bucket of warm water. Working with a clean sponge or white cloth, start from the outside of the stain and work your way to the center. This method will keep the stain from spreading. Do not over saturate as this may cause de-lamination. No need to scrub, simply rub lightly or dab the stain.

You may have to repeat this procedure more than once to achieve desired results. Finish up with clean water, using the same method, and blot dry. REMEMBER, this is polypropylene, basic plastic, so do not be afraid to clean it.

Steam cleaning is also an option. Again, take care not to over-saturate the material.



**IMPORTANT:**

*The fabric manufacturer's recommendeds made above are done in good faith and are based on a history of actual experiences and laboratory evaluations. Foss Manufacturing Company, Inc. and/or its designed distributor does not warrant, either expressed or implied, the effectiveness of the cleaning agents listed and the process for cleaning described above.*

---

## CABINETRY

Wooden items may be cleaned with a soft cloth and a good quality wood finish cleaning product such as Guardsman™ or equivalent.

Vinyl simulated wood (Plus-Wood) panels may be cleaned with a mild, water based cleaner and a soft cloth. Do not use solvents on vinyl wood panels.

*NOTE: Many cabinetry and furniture items throughout this motor home are constructed either partially or completely of real hardwoods. Because of natural variations in woodgrain density, slight differences in stain hue may exist between one item and another. This is the distinctive character and beauty of real wood.*

---

## VINYL WALLBOARD

Decorative vinyl covered wallboards may be cleaned with a mild solution of water and isopropyl (rubbing) alcohol or a mild soap solution. Do not use solvents or abrasive cleaning products.

---

## CARE AND MAINTENANCE OF YOUR SOLID SURFACE COUNTERTOP

You can easily maintain the beauty of your countertop with little effort, under most circumstances, using a window spray cleaner, warm soapy water or other general purpose spray cleaner. You can also use liquid or gel-type cleaners containing bleach. Because the material is non-porous, stains cannot penetrate below the surface and will nearly always disappear using these cleaning methods.

**If a stain has dried on**, allow the cleaner or soapy water time to soften the area, after which the stain will wipe off.

**If the stain is not water-base or oil-base** material, you may need to gently remove it using a plastic scraper (disposable plastic knife for example) followed by normal cleaning methods described above.

**You may want to scrub** the entire surface periodically. Do this lightly and evenly with a mild abrasive cleaner such as Soft-Scrub®, Bon Ami® or Barkeeper's Friend®.

**Always use a cutting board** rather than slicing foods directly on your countertop. The underside of one of your sink covers will provide an easily accessible cutting surface. This will keep your countertop looking its best and minimize care efforts. (An occasional sanding with a medium grade (120 grit) sandpaper will remove any cut marks accumulated on the sink cover bottom).

**To remove cuts and scratches**, use a more aggressive cleansing powder such as Comet®, a moistened SOS® pad or green Scotch-Brite® pad. We recommend that you finish the entire surface using the same cleansing material and scrubbing method to maintain a uniform appearance.

**If you prefer a glossier look**, follow up with a good quality furniture polish such as Pledge® or a liquid automotive wax (non-cleaner type).

**Use trivets and 'hot pads'** under hot cooking pans. Do Not set hot pads or pans directly from the stove or oven onto the counter. The solid surface material is extremely heat resistant, but sudden contact by a very hot material with a cold countertop surface could cause a crack that would need to be repaired. Likewise, concentrated high heat sources in a small area, such as a crock pot or an electric griddle may cause a crack. We strongly recommend using a trivet under these. Also, do not allow candles to burn directly on the counter surface.



**Avoid paint remove or oven cleaner.** The solid surface material is also resistant to most chemical substances but exposure to some harsh chemicals and solvents such as these can cause damage that would need professional repair or replacement. If one of these materials does spill or drip onto the counter surface, wipe it up immediately to avoid damage.

**Technical Assistance.** If you need assistance or advice on care and maintenance of your solid surface countertops, contact the countertop manufacturer. Vendura Industries, Phone 608-223-9555.

### STAINLESS STEEL SINK

The stainless steel sink can be cleaned with soap or detergent. Rinse thoroughly with warm water and wipe dry to avoid streaks.

Use a mild abrasive for stubborn stains. Work in the direction of the polish lines. To keep the original finish, polish with a wax cleaner and rub with a dry soft cloth.



### **WARNING**

Salts, mustard and mayonnaise may causing pitting. If spilled, clean immediately.

### RANGE AND REFRIGERATOR

For care and appearance maintenance of the range and refrigerator, refer to the operation and maintenance manual for each of the individual appliances included in your InfoCase.



### BATHROOM

The tub and shower walls in the bathroom should be cleaned with a mild soap and water solution, or (to obtain maximum luster) use a good quality wax cleaner. Do not use an abrasive cleaner on the shower walls and tub. If the shower has a glass door, it is extremely important that

abrasives not be used. Use only a good quality glass cleaner or mild detergent and water solution with a soft cloth to clean glass surfaces.

The bathroom lavatory is also a molded plastic material and should be cleaned with a mild soap and water solution. Abrasive cleaners or harsh detergents should not be used.

For instructions on the care of your fresh water toilet, refer to the information in your InfoCase.

### DOORS AND WINDOWS

Windows may be periodically cleaned with a good quality glass cleaner or mild soap solution using a soft cloth. Use care when removing ice or frost from the windows. Always use a plastic ice scraper, never one made of metal. Use care when removing ice from the mirrors to protect the reflective surfaces.

Door locks and hinges should be lubricated periodically with powdered graphite to ensure trouble-free operation and to protect against freeze-up.



### VEHICLE MAINTENANCE

(See also Safety Precautions, Section 1 of this manual).



### CHASSIS SERVICE & MAINTENANCE

Consult the appropriate sections in your chassis operating guide for specific information regarding operating safety, service recommendations and maintenance schedules for the chassis section of your motor home.

### Oil Change Reminder - Workhorse Chassis

The engine controller monitors the engine oil life remaining and will display the message "Change Engine Oil" on the Odometer/Message Center display when an oil change is due. This 'counter' must be reset at the time the oil change service is performed to be able to alert you for the next change.



## To Reset Oil Change Reminder:

- Turn the ignition switch to “ON” but Do Not Start the engine.
- Fully press-and-release the accelerator pedal 3 times within 5 seconds, then turn ignition “OFF” for at least 10 seconds.
- The 3000-mile oil life counter on the engine controller will be reset to start a new cycle.

## ENGINE ACCESS

### HOOD

Insert the tamper-resistant hood key into the hood locks and turn them to the right (clockwise) to unlock the hood.

Swing the hood outward and down. Do not let hood drop.

To close the hood, lift and swing inward. Turn key locks to the left (counterclockwise) to lock hood closed.

With the hood open, the engine oil dipstick, oil fill, radiator fill, power steering reservoir and windshield washer reservoir are accessible.

### ENGINE COVER

- Remove the beverage tray from the engine cover. Remove the drawer to expose the wing nut fasteners that hold the tray to the motor cover.
- Insert the supplied hex wrench into the hole in the rear top or edge of the engine cover.

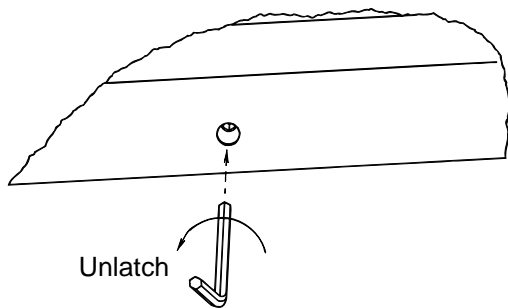

- Turn the hex wrench to the left (counterclockwise) to unlatch.
- Lift the rear end of the cover upward and pull the cover from the opening.
- To reinstall the cover, position the front end of the cover first, then lower the rear end. It is important to be sure the front edge is pushed completely forward to the radiator cover to

ensure an air-tight seal.

- Press the rear end of the cover down and turn the hex wrench to the right (clockwise) until the latch pulls the cover downward and stops.
- Refasten the beverage tray to the motor cover.

Removal of the engine cover allows service access to the engine air cleaner and other engine parts.



## ENGINE COOLING SYSTEM

Refer to your chassis operating guide for information and precautions on filling, servicing and checking the fluid level.

*NOTE: Your chassis engine cooling system is filled with special extended-life coolant that is not the same as common anti-freeze available at retail outlets.*

*The coolant system MUST be refilled or topped up with the same type of coolant as equipped to maintain the special long-life properties.*

*Workhorse chassis use GM Dexcool LLC, which is a bright, pink/orange color.*

*Ford chassis use Ford Premium Gold (GO 5), which is a golden color.*



### CAUTION

When refilling the coolant system of a vehicle equipped with a rear auxiliary automotive heater and motoraid water heater, be sure to allow for additional coolant capacity of the heater and its supply and return hoses.



**TIRES**

Low air pressure results in tire overloading and abnormal wear and also affects handling and fuel economy. Obtain proper inflation pressures from your chassis operating guide or tire manufacturer.

 **WARNING**

Make sure all replacement tires are of the same size and ply rating as those installed as original equipment.

See the Vehicle Certification Label affixed to the rear edge of the driver's door for tire information.



**SUSPENSION ALIGNMENT AND TIRE BALANCE**

The front suspension and steering system of this vehicle was factory aligned using highly accurate equipment prior to delivery to the dealership. However, we recommend that alignment be checked and adjusted, if necessary, after you have fully loaded the motor home according to your personal needs. Thereafter, the alignment should be periodically inspected to help prevent uneven tire wear.

Any excessive or abnormal tire wear may indicate worn or misaligned suspension or steering, unbalanced tire or other tire/suspension problem.

Alignment can be affected by worn steering/suspension parts or by incidents which happen during driving, such as hitting a curb, pothole or railroad track, etc. Improper alignment can cause tires to roll at an angle and wear unevenly. It may also cause the vehicle to "pull" to the right or left. Have your dealer inspect your vehicle's suspension and steering components periodically for misalignment or wear.

Out-of-balance tires will not roll smoothly and can lead to annoying vibrations and uneven tread wear such as cupping and flat spots. Tires may

need to be balanced if uneven wear is detected or if ride comfort decreases noticeably.

See your chassis operating guide for further information.

**FRONT AIR SPRINGS - Workhorse Chassis**

Some workhorse chassis are equipped with air bags inside the front suspension springs. See your Workhorse owner's manual for inspection instructions and air pressure specifications.

**Loading the Vehicle**

***NOTE: Your motor home's load capacity is designated by weight, not by volume, so you cannot necessarily use all available space when loading your motor home. See page 4-1 for more information.***



**WINDSHIELD WASHERS AND WIPERS**

See your chassis operating guide for recommendations and precautions regarding washers and wipers.



**LIGHTS**

All exterior lights should be checked for proper operation each time the vehicle is prepared for a trip. Any bulbs which fail to light should be checked and replaced, when necessary, with a new bulb of the same size. A failure of more than one light, such as both taillights not operating, may indicate a burned out fuse. Check fuse and replace with one of the same rating when necessary. If a fuse is not the cause of the problem, the wiring system should be checked immediately by an authorized service center.

The headlight circuit is protected by a circuit breaker. An overload on the breaker will cause the lights to flicker on and off. Headlight wiring should be checked immediately anytime this condition is apparent. Refer to your chassis operating guide for further information.





## AUTOMOTIVE 12-VOLT FUSES AND CIRCUIT BREAKERS

The automotive fuses and breaker are conveniently located on a panel beneath the hinged instrument panel pod. Lift the pod upward as shown.

The circuit breakers will pop outward if they are tripped. Simply push in to reset.

Always replace plug-in type fuses with those of the same amperage size. See chassis guide for fuse application table.

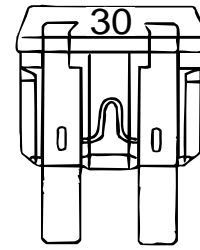

Good Fuse

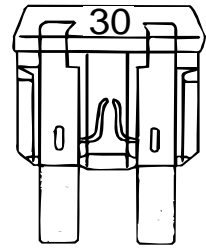

Bad Fuse



Automotive 12-Volt Fuse Block  
(Under lift-up dash pod)

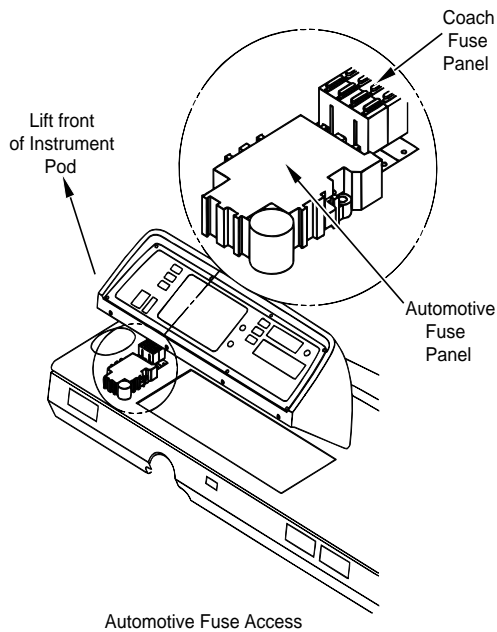





### PREPARING VEHICLE FOR STORAGE

Properly preparing your vehicle for storage will lessen the possibility of damage to your vehicle. Prepare the motor home for vacancy just as you would if you were leaving your house for an extended period:

- Remove all perishables from cabinets and refrigerator
- Prop refrigerator door open.
- Turn off LP gas tank.
- Drain water heater, water tank and holding tank.
- Drain optional washer/dryer. (See “Washer/Dryer Winterizing” at the end of this section.
- Close shades to protect upholstery from sunlight

When storing your vehicle through the winter, or in cold climates, extra preparations need to be made to protect systems that can be damaged by freezing temperatures.



### Cold Weather Storage Procedure (Winterizing)

1. Clean and dump holding tanks by following steps A, B, and C
  - A. Add water to the sewage holding tank by holding the toilet flush lever open with the water pump running. Add water to the waste water holding tanks by opening the kitchen, shower and lavatory faucets. Tanks should be about 1/4 to 1/3 full to rinse properly. Driving to a disposal site will normally loosen and rinse any waste material from the sides of the tank.
  - B. Completely drain the sewage and waste water holding tanks at an approved waste disposal site. Drain the sewage tank first so the following waste water can rinse any waste solids from the dump outlet and sewer hose.

- C. Close dump valves and refit the dust cap onto the drain outlet.
2. Level the motor home and drain the entire plumbing system as described in the following steps.
  3. Open all drain valves. (See the water system drain valve chart on page 7-7 and 7-8 for locations on your model.)

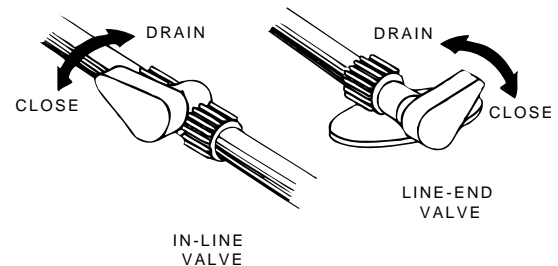

*NOTE: If your coach is equipped with a water purifier system, you will need to remove the filter cartridge and install the diverter plug supplied. The cartridge is located beneath the galley sink counter. The diverter plug must be removed and a filter cartridge installed before resuming normal use of the water system. The plug is intended for winterization only.*

4. Remove and discard the water purifier filter cartridge.
  - Raise the valve handle and turn the colored ring fully clockwise.
  - Twist the filter cartridge counterclockwise about a quarter-turn and pull it down and out of the filter head.



- Place a container beneath the filter head and lower the valve handle to drain any water remaining in the filter lines.



Water Filter Assembly -  
Below Galley Sink

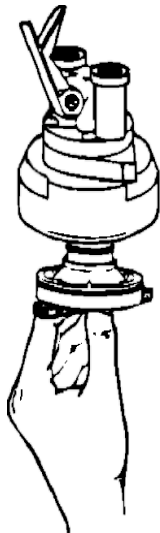

5. Install the antifreeze diverter plug -
  - Raise the valve handle on the filter base.
  - Hold the diverter by the support bar as shown and guide it up into the filter base.
  - Push the diverter up into the head as far as possible and turn it clockwise approximately 90° until it stops.
  - Lower valve handle to lock the diverter plug in place.

*NOTE: Before using again the following spring:*

- *Flush out the system with the diverter in place.*
  - *After the system has been thoroughly flushed, remove the diverter and store for future use.*
  - *Install a new water filter cartridge.*
6. Operate the toilet flush lever and hold until water stops flowing in the toilet. Then turn water pump switch OFF.
  7. Turn off the water heater power switch before draining the water heater tank to avoid damage to the heating element. Drain the water heater by removing the plug from the base of the water heater tank, accessible from the outside of the coach. (Requires socket and ratchet.) Also open the Pressure-Temperature relief valve at the top right portion of the tank to prevent air locking in the tank while draining.

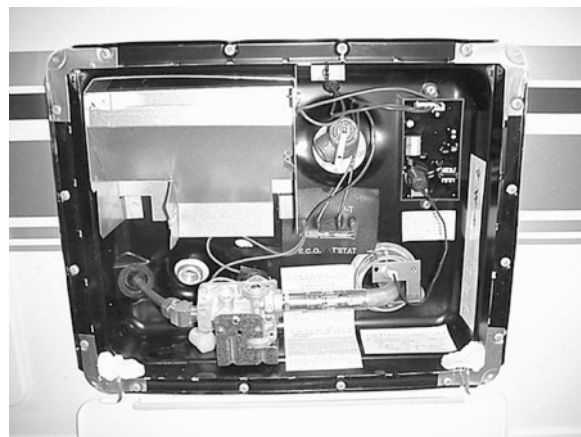

Water Heater Exterior Service Access



8. After water has stopped draining at all faucets and drain valves, connect a “blow-out” plug to the city water connection on the coach. Then use a compressed air hose regulated to 30 psi or less to force air through the system. (A “blow-out” plug can be purchased at any Winnebago or Itasca dealer. P/N 701705-01-000.)

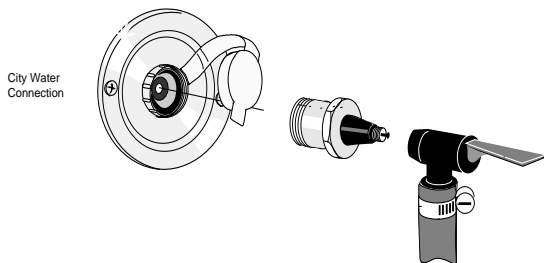

|  |
|--|
|  <b>CAUTION</b> |
| Limit air pressure to 30 psi to avoid damage to pump or water lines.                             |

*NOTE: DO NOT burst air into the system. This can damage the water pump. It is better to let air in slowly.*

9. Let air flow for five minutes until water is completely drained out of faucets and drain valves. Then close faucets one at a time.
10. Operate and hold toilet flush lever until water is completely drained from toilet.



11. Now turn air pressure off and disconnect water purge adapters. Recap the city water connection to avoid contamination by dirt or insects.
12. Close all drain valves and faucets to avoid contamination by dirt or insects. Reinstall water heater drain plug and close P-T relief valve.
13. Pour about one cup of non-toxic RV antifreeze into the kitchen sink drain, bathroom sink drain and shower drain. This prevents any holding tank odors from entering the coach during storage.

|   |
|---|
|  <b>WARNING</b>  |
| NEVER use automotive antifreeze/coolant in your RV water system. Auto antifreeze contains ethylene glycol which, if ingested, can cause blindness and can be fatal. |

It is not necessary to add antifreeze to the toilet since the flush valve will be closed.

Do not add automotive antifreeze or caustic chemicals such as bleach or laundry detergents into the toilet bowl or holding tanks. Although these products may have a deodorizing effect, they may damage plastic and rubber parts in the system.

*NOTE: As an alternative to totally draining the plumbing system, you may winterize tanks and lines by pumping non-toxic RV antifreeze through the system. This product is available from your dealer and from most RV supply stores. Follow directions on the container to determine the correct amount to use for your coach.*

*If your coach is equipped with the optional water heater by-pass valve, you can fill the hot water lines with antifreeze solution without filling the water heater tank. See page 8-9 for information on the by-pass valve.*



**Water System Winterization Valve**

Your coach is equipped with a manually operated water line winterization system for your convenience in winterizing fresh water lines.

The system features a diverter valve and suction tube in-line between the tank and water pump to draw non-toxic RV water system antifreeze into the water lines. This feature is located near the water pump and drain valves. See page 7-7 or 7-8 for location in your coach.

*To Fill Lines with RV Water Line Antifreeze*

- Turn water heater by-pass valve to BY-PASS position.



- Remove and save the protective cap from the end of the siphon tube.



- Insert the end of the suction tube into a pail or other container with 2 to 3 gallons of non-toxic RV antifreeze solution.
- Turn the diverter valve handle to DIVERT.

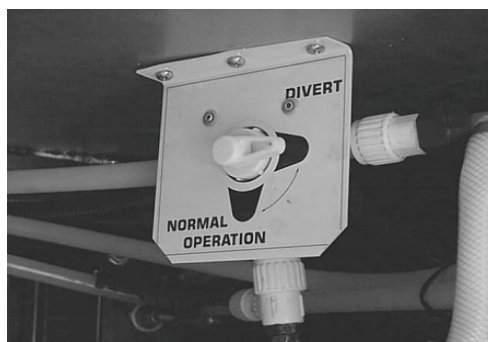

- Turn the water pump switch on.
- Open each cold water faucet handle in the coach one at a time until antifreeze solution just begins to flow from the faucet, then close.

*When Done Adding RV Antifreeze:*

- Turn water pump switch off.
- Turn the diverter valve handle so it points toward the water line to the pump as shown in the photo. This will stop the flow from the suction tube and revert the tank line flow to the pump.
- Replace the protective cap onto the end of the suction tube to keep out insects and debris when not in use.

|   |
|---|
|  <b>CAUTION</b>   |
| <p>Leave by-pass valve handle in NORMAL FLOW position if draining water and blowing out water lines. Place in BYPASS position ONLY when using antifreeze solution in water lines.</p> |

14. Place a bucket beneath the sewage drain valve outlet and re-drain the sewage and waste holding tanks of any clean water that entered during “blow-out” procedure.

Close dump valves to prevent valve shafts from rusting and to prevent entry by rodents and insects. Refit the dust cap onto the drain outlet.

Your drainage and fresh water systems are now totally winterized.



15. Have the vehicle chassis completely serviced and lubricated. Be sure radiator antifreeze protection level is sufficient for the lowest anticipated temperatures.
16. Wash and wax the coach.
17. Inspect all seams and seals around doors, windows, vents, and any other joints. Replace or repair any that are damaged. Sealing materials and compounds can be purchased from your dealer. Badly damaged weather seals may need to be replaced by your dealer.
18. Close all windows and roof vents. Protect all appliance vent openings from contamination by animals or insects (e.g. bird nests, wasp nests, etc.)
19. Lubricate all door hinges and locks.
20. Clean the interior of the coach. Dirt and stains are more easily removed when fresh.
21. Remove all foods and items that may cause odors.
22. Clean and defrost the refrigerator. Leave the door slightly ajar to allow any odors to dissipate. Place an open box of baking soda inside the refrigerator to help absorb odors.
23. Turn the furnace thermostat switch on the bottom of the thermostat to OFF.
24. Turn auxiliary battery (Aux Batt) switch off. If your coach does not have an Aux Batt switch, disconnect all chassis and auxiliary battery cables.
25. Fully charge batteries.
26. Batteries must be kept to at least 80% charge to keep from freezing or sulfating. We recommend that you connect a battery charger and fully charge batteries at least once a month during long-term storage periods to maintain charge at 80% or greater. Turn Aux. Batt. switch off to avoid electrical arcing when attaching and detaching charger clamps.

*NOTE: We do not recommend leaving the shoreline plugged in continuously during storage periods because the batteries can lose electrolytic fluids and become damaged from continuous charging without periodic use.*

*We recommend following regular battery inspection and maintenance, especially in cold weather.*

## Washer/Dryer Winterizing

1. Turn off the hot and cold water faucets to the machine and disconnect the hoses. (Tie or wire up the hoses to the faucets to keep them from dropping down behind the machine.)
2. Set the machine to fill on regular cycle and WARM wash.
3. Turn the machine On for a few minutes so it can take in any water left in the hoses. (Lift the hoses at this time to be sure no water is trapped in low spots of the hose.)
4. Turn the machine off.
5. Advance the wash time to SPIN cycle and turn the machine On to pump out as much water as possible.
6. Turn the machine Off again.
7. Place a bath towel or shallow container beneath the drain/lint filter door on the lower front of the machine to catch water. Then remove the filter to drain any water left in the bottom of the machine.
8. Reinstall the filter correctly to assure that it does not leak water.
9. Optional - If you wish to add RV antifreeze to ensure safety of the washer pump, add about a gallon of non-toxic RV water system antifreeze to the washer drum and rerun the SPIN cycle to fill the pump and lower cavities with the solution.
10. Turn the machine Off.

Washer/dryer winterizing is now complete.

*NOTE: Remember to reconnect the washer supply hoses when placing the washing machine back into service. Then run the machine through the fill/spin cycle (steps 2-6 above) to remove and rinse the RV antifreeze from the machine.*

*NOTE: We do not recommend leaving the shoreline plugged in continuously*



## SECTION 10 STORING YOUR MOTOR HOME

# BR AVE

*during storage periods because the batteries can lose electrolytic fluids and become damaged from continuous charging without periodic use.*

*We recommend following regular battery inspection and maintenance, especially in cold weather. See “Battery Maintenance” in Section 6 - Electrical Systems.*

14. Check tires for proper cold inflation pressure.
15. After washing accumulated winter grime from the vehicle, it is important to carefully inspect the seams and sealants for separation or cracks that may have appeared around the window frames, vents and any other joints. Re-sealing is quite simple and the material is quickly and easily applied. Appropriate compounds are available from your dealer. Also inspect weather seals around doors, etc., and if necessary, have a dealer replace immediately.



## REMOVAL FROM STORAGE

1. Completely air out the motor home.
2. Have the entire LP gas system checked for leaks.
3. Check window operation.
4. Check cabinet and door hinges. Lubricate with penetrating oil, if necessary.
5. Close all faucets and drain valves that are open. If necessary, reconnect toilet water line and close flush valve.
6. Add a few gallons of water to the fresh water tank and check for leaks especially at junctions. Also make sure all hangers and supports are securely in place. Sanitize the water system as outlined under “Disinfecting the Fresh Water System” in Section 7.
7. Check operation of all faucets to be sure faucet washers have not hardened during storage.
8. Check sealing valve in the toilet for proper operation and lubricate with silicone spray.
9. Add water to the holding tank using the toilet flush pedal. Check to be sure dump valve seals tightly.
10. Check around all appliances for obstructions and ensure that all vent openings are clear.
11. Start refrigerator and check for proper cooling.
12. Clean paneling and counter surfaces and apply a thin coat of wax.
13. Replace batteries if necessary and check out electrical system to make sure all lights and electrical components operate.



# BR AVE

## INDEX

---

|  |       |  |       |
|--|-------|--|-------|
| 110-Volt AC System.....                                | 6- 1  | Chassis Fuel Tank.....                               | 2- 2  |
| 110-Volt Circuit Breakers.....                         | 6- 3  | Chassis Operating Guide .....                        | 0- 1  |
| 110-Volt Receptacles (Outlets).....                    | 6- 3  | Chassis Service and Maintenance.....                 | 9- 6  |
| 12-Volt DC System.....                                 | 6- 6  | Child Restraints.....                                | 2- 7  |
| 12-Volt House Fuses and Circuit Breakers... 6- 6       |       | Coach Leveing Systems.....                           | 2- 13 |
| <b>A</b>   |       | Coffee Maker .....                                   | 8- 21 |
| About This Manual .....                                | 0- 1  | Cold Weather Storage Procedure<br>(Winterizing)..... | 10- 1 |
| Air Conditioning .....                                 | 2- 12 | Comfort Controls .....                               | 2- 11 |
| Air in the LP Gas Tank .....                           | 5- 3  | Connecting A Battery Charger .....                   | 3- 5  |
| Armrest Adjustment.....                                | 2- 6  | Connecting Jumper Cables .....                       | 3- 4  |
| Automotive 12-Volt Fuses and<br>Circuit Breakers ..... | 9- 9  | Couch Bed Conversion .....                           | 8- 16 |
| Aux. Start Switch.....                                 | 6- 9  | Crank-Out Side Windows.....                          | 8- 19 |
| Auxiliary 110-Volt Generator.....                      | 6- 4  | Cruise Control.....                                  | 2- 11 |
| Auxiliary Battery (Aux. Batt) Switch.....              | 2- 12 | <b>D</b>   |       |
| Auxiliary Battery (Aux. Batt) Switch.....              | 6- 9  | Day/Nighter Pleated Blinds .....                     | 8- 20 |
| <b>B</b>   |       | DC-AC Electrical Voltage Inverter .....              | 8- 15 |
| Bathroom .....   | 9- 6  | Defrosting .....                                     | 2- 11 |
| Battery Access .....                                   | 6- 7  | Deluxe Sound System.....                             | 2- 8  |
| Battery Boost Switch .....                             | 2- 12 | Dinette/Bed Conversion.....                          | 8- 15 |
| Battery Charge Meter.....                              | 8- 7  | Disinfecting Fresh Water Systems.....                | 7- 3  |
| Battery Condition Meter .....                          | 6- 9  | Doors and Windows.....                               | 9- 6  |
| Battery Storage and Maintenance .....                  | 6- 7  | Drinking and Driving.....                            | 0- 2  |
| Before Driving Your Vehicle .....                      | 2- 1  | Driving .....  | 1- 2  |
| Before Driving .....                                   | 0- 2  | Dual Rear Wheels .....                               | 3- 2  |
| Before Entering Your Vehicle .....                     | 2- 1  | Ducted Roof Air Conditioning System.....             | 8- 11 |
| Beverage Tray.....                                     | 2- 13 | Dumping Holding Tanks .....                          | 7- 6  |
| Blocking.....  | 4- 6  | <b>E</b>   |       |
| Brake Shift Interlock.....                             | 2- 3  | Effects of Prolonged Occupancy .....                 | 4- 7  |
| <b>C</b>   |       | Electric Entrance Step.....                          | 2- 4  |
| Cabinetry.....   | 9- 5  | Electrical .....                                     | 1- 4  |
| Cable TV Hook-Up.....                                  | 8- 14 | Emergency Exits .....                                | 1- 6  |
| Campsite Selection .....                               | 4- 6  | Engine Cooling System .....                          | 9- 7  |
| Car or Trailer Towing.....                             | 4- 2  | Engine Cover .....                                   | 9- 7  |
| Carbon Monoxide Alarm .....                            | 1- 6  | Engine Overheat .....                                | 3- 5  |
| Carbon Monoxide Warning .....                          | 1- 5  | Entrance Door Lock and Handle .....                  | 2- 3  |
| Care of Ceiling Fabric.....                            | 9- 3  | Equipping for Travel.....                            | 4- 4  |
| Care of Stripes and Decals.....                        | 9- 2  | Exterior Entertainment Center .....                  | 8- 15 |
| Carpet Care & Cleaning.....                            | 9- 2  | Exterior Feature Identification.....                 | 0- 5  |
| CB Radio Wiring .....                                  | 6- 9  | Exterior Shower/Wash Station.....                    | 7- 5  |
| Charging Section.....                                  | 6- 3  | Exterior .....                                       | 9- 1  |
| Chassis (Starting) Battery .....                       | 6- 6  | External Power Cord (Shoreline).....                 | 6- 1  |
|  |       | External Water Supply (City Water) .....             | 7- 4  |

---

- 
- F**
- Filling the Tank..... 2- 2
  - Fire Extinguisher..... 1- 7
  - Formaldehyde Information ..... 1- 5
  - Fresh Water System ..... 7- 1
  - Fresh Water Toilet ..... 8- 18
  - Front Air Springs ..... 9- 8
  - Front Axle Tire Alignment ..... 4- 1
  - Front Wheel ..... 3- 2
  - Fuel and LP Gas..... 1- 2
  - Fuel Selection ..... 2- 2
- G**
- Gasoline Fuel Fill..... 2- 2
  - Gelcoat Fiberglass Finish ..... 9- 1
  - General Warnings ..... 1- 1
  - Generator Hourmeter ..... 6- 5
  - Generator Hourmeter ..... 8- 8
  - Generator Start/Stop Switch ..... 8- 8
  - Ground Fault Circuit Interrupter..... 6- 4
- H**
- Hazard Warning Flasher ..... 3- 1
  - Hazard Warning Lights..... 2- 3
  - Headlight Beam Change and Turn Signals. 2- 11
  - Heat Pump..... 8- 10
  - Heating..... 2- 11
  - Holding Tank Level Indicators ..... 7- 6
  - Hood Fan and Light Switches..... 8- 6
  - Hoop Chair Mount ..... 8- 18
  - House Batteries ..... 6- 6
  - How LP Gas Works ..... 5- 1
  - Humidity and Consensation..... 4- 7
  - Humidity Storage Switch..... 8- 4
- I**
- Instrument Panel Gauges and Controls..... 2- 9
- J**
- Jump Starting ..... 3- 4
- K**
- Keys ..... 2- 2
- L**
- Lap Belts ..... 2- 6
  - Leather Upholstery..... 9- 3
  - Leveling Procedure ..... 2- 13
  - Leveling ..... 4- 6
  - Lighting Oven Pilot ..... 8- 5
  - Lights ..... 9- 8
  - Loading the Vehicle..... 4- 1
  - Loading ..... 1- 5
  - LP Gas Alarm ..... 1- 3
  - LP Gas Furnace (Suburban)..... 8- 10
  - LP Gas Leaks ..... 1- 3
  - LP Gas Leaks ..... 5- 4
  - LP Gas Level ..... 8- 7
  - LP Gas Output ..... 5- 2
  - LP Gas Supply ..... 5- 1
  - LP Tank System..... 5- 2
- M**
- Maintenance..... 1- 5
  - Microwave Oven..... 8- 6
  - Mirrors ..... 2- 8
  - Motor Aid ..... 8- 9
  - Motor Home Tire Changing Procedure ..... 3- 2
  - Mountain Driving ..... 4- 6
  - Multi-Function Signal Lever ..... 2- 11
- N**
- Nighttime Driving..... 4- 6
- O**
- Options and Equipment ..... 0- 1
  - Owner's InfoCase ..... 0- 1
- P**
- Park Fuses or Breakers ..... 6- 2
  - Parking Brake ..... 2- 3
  - Parking Brakes..... 2- 3
  - Passenger Work Station ..... 2- 13
  - Power Center (Converter)..... 6- 2
  - Power Connection..... 1- 4
  - Power Electric Mirrors..... 2- 8
  - Power Roof Vent ..... 8- 19
  - Powerline Energy Management System  
(EMS)..... 6- 2
  - Preparing Vehicle for Storage..... 10- 1
  - Pressure-Temperature Relief Valve..... 8- 8
  - Pre-Travel Checklist ..... 4- 3
  - Pump Strainer Filter..... 7- 2
- Q**
- Quartz Wall Clock ..... 8- 20
-

## R

|                                      |       |
|--------------------------------------|-------|
| Radio Power Switch.....              | 2- 8  |
| Range and Oven.....                  | 8- 4  |
| Range and Refrigerator.....          | 9- 6  |
| Range Hood.....                      | 8- 6  |
| Rear Coach Heater.....               | 2- 12 |
| Rearview TV Monitor System.....      | 2- 9  |
| Recovery Towing.....                 | 3- 3  |
| Refrigerator.....                    | 8- 1  |
| Regulator.....                       | 5- 4  |
| Removal from Storage.....            | 10- 6 |
| Reporting Safety Defects.....        | 0- 2  |
| Rest Easy Multi-Position Lounge..... | 8- 16 |
| Roof Loading.....                    | 4- 2  |
| Roof.....                            | 9- 1  |
| RV Radio.....                        | 2- 8  |

## S

|  |       |
|--|-------|
| Safe Use of the LP Gas System.....         | 5- 1  |
| Safety Precautions.....                    | 3- 2  |
| Seat Belt Care and Cleaning.....           | 2- 7  |
| Seat Belts.....                            | 2- 6  |
| Seats.....                                 | 2- 5  |
| Selecting LP Fuel Types.....               | 5- 2  |
| Service and Assistance.....                | 0- 2  |
| Severe Weather Information.....            | 4- 5  |
| Shower Hose Vacuum Breaker.....            | 7- 5  |
| Signal Amplifier.....                      | 8- 13 |
| Sleeping Facilities.....                   | 8- 15 |
| Slideout Room.....                         | 2- 15 |
| Slider Windows.....                        | 8- 20 |
| Smoke Alarm.....                           | 1- 8  |
| Spare Tire Storage.....                    | 3- 1  |
| Stainless Steel Sink.....                  | 9- 6  |
| Starting and Stopping Engine.....          | 2- 3  |
| Starting and Stopping the Generator.....   | 6- 4  |
| Suspension Alignment and Tire Balance..... | 9- 8  |
| Swing-Out Rear Escape Window.....          | 1- 7  |
| SWR Adjustment.....                        | 6- 9  |
| Systems Monitor Panel.....                 | 8- 6  |

## T

|                                 |       |
|---------------------------------|-------|
| Tank Capacities.....            | 7- 8  |
| Thermal Overload Protector..... | 6- 3  |
| Tires.....                      | 9- 8  |
| Trailer Wiring Connector.....   | 6- 10 |
| Travel Straps.....              | 2- 15 |
| Travel Tips.....                | 4- 4  |

|                 |       |
|-----------------|-------|
| TV Antenna..... | 8- 12 |
|-----------------|-------|

## U

|   |      |
|---|------|
| Underbody.....                            | 9- 1 |
| Upholstery.....                           | 9- 2 |
| Use of Top Burners.....                   | 8- 5 |
| Using On-Site Sewer Hook-Ups.....         | 7- 6 |
| Using Slider Widows As Emergency Exits .. | 1- 7 |

## V

|                                  |       |
|----------------------------------|-------|
| Vehicle Certification Label..... | 0- 4  |
| Ventilation.....                 | 2- 12 |
| Video Selection Center.....      | 8- 14 |
| Vinyl Wallboard.....             | 9- 5  |

## W

|  |       |
|--|-------|
| Warranty.....  | 0- 2  |
| Washer/Dryer Winterizing.....                          | 10- 5 |
| Waste Water System (Holding Tanks).....                | 7- 5  |
| Water and Holding Tank Levels.....                     | 8- 7  |
| Water Heater By-Pass Valve.....                        | 8- 9  |
| Water Heater Switch and "W.H. Pilot"<br>Indicator..... | 8- 8  |
| Water Heater.....                                      | 8- 8  |
| Water Line & Tank Drain Valves.....                    | 7- 6  |
| Water Pump Switch.....                                 | 8- 7  |
| Water Pump.....  | 7- 2  |
| Water Purifier (Filter) System.....                    | 7- 3  |
| Water Stains.....                                      | 9- 4  |
| Water System Drain Valve Locations.....                | 7- 9  |
| Water System Winterization Valve.....                  | 10- 4 |
| Weighing Your Loaded Vehicle.....                      | 4- 1  |
| Wheel Nuts.....  | 3- 3  |
| Windshield Washers and Wipers.....                     | 9- 8  |
| Windshield Wipers and Wiper Delay.....                 | 2- 11 |
| Winter Use of LP Gas.....                              | 5- 5  |



## IMPORTANT SERIAL NUMBERS

Motor Home (Coach): Year \_\_\_\_\_ Model \_\_\_\_\_ Serial \_\_\_\_\_

Chassis: Make \_\_\_\_\_ Serial (VIN) \_\_\_\_\_

Roof Air Conditioner:      Brand \_\_\_\_\_ Model \_\_\_\_\_ Serial \_\_\_\_\_

Furnace:                      Brand \_\_\_\_\_ Model \_\_\_\_\_ Serial \_\_\_\_\_

Water Heater:              Brand \_\_\_\_\_ Model \_\_\_\_\_ Serial \_\_\_\_\_

Power Converter:          Brand \_\_\_\_\_ Model \_\_\_\_\_ Serial \_\_\_\_\_

110-Volt Generator:      Brand \_\_\_\_\_ Model \_\_\_\_\_ Serial \_\_\_\_\_

Range:                        Brand \_\_\_\_\_ Model \_\_\_\_\_ Serial \_\_\_\_\_

Microwave Oven:          Brand \_\_\_\_\_ Model \_\_\_\_\_ Serial \_\_\_\_\_

Refrigerator:                Brand \_\_\_\_\_ Model \_\_\_\_\_ Serial \_\_\_\_\_

Television:                  Brand \_\_\_\_\_ Model \_\_\_\_\_ Serial \_\_\_\_\_

Video Cassette Player:    Brand \_\_\_\_\_ Model \_\_\_\_\_ Serial \_\_\_\_\_

## EMERGENCY INFORMATION

### Dealer

Name \_\_\_\_\_

Address \_\_\_\_\_

Phone \_\_\_\_\_

### INSURANCE POLICY

Company \_\_\_\_\_

Policy Number \_\_\_\_\_

Phone \_\_\_\_\_





